



Bring joy and happiness

● Silicone cosmetic prostheses

REGAL PROSTHESIS LIMITED

2015 ● ● ●
Version 3.1

Table of contents:

Contents	Page
Quality Assurance	2
Why choose Regal product?	3
Product Overview	4-5
Silicone Prostheses: Ready Made	6-8
Silicone Prostheses: Semi-Custom Made (SCM)	6-12
Silicone Prostheses: Optional Features	13-25
Complete product structure	26-27
Silicone Myo glove: Model 100L,100	28-29
Silicone Myo glove (Pediatric): Model 100PL	30
Silicone Prosthetic glove: Model 101L,102LS, 102L, 101LL,102LSL, 102LL	48
Silicone Partial hand glove: Model 103	49
Silicone Prosthetic finger: Model 200 series	50
Silicone Child crawling hand: Model CH	51
Silicone Footcover: Model HDSFHT-ER, HDSFHT, HDSF-ER, HDSF	104-105
Silicone Prosthetic toe: Model TOE series	106-107
Silicone Prosthetic arm sleeve: Model SL-50, SL-29	138-139
Silicone Prosthetic leg sleeve: Model BKSL	140-141
Silicone maxillofacial prostheses	142
Silicone prostheses accessories	143-145
How to order	146
How to measure	147
Frequently Asked Questions	148-153
Warranty and Return Policy	154-155

Our Quality Management System and Product Certification:



ISO13485:2016
Design and manufacture of
Silicone Cosmetic Prostheses
and Supply of Prosthetics and
Orthotics products



ISO9001:2015
Quality management system
certification



CE certification



Silicone prosthesis test
according to ISO standard



Silicone prosthesis flammability test



Silicone prosthesis toxicity test

Why choose Regal product?

Bring joy and happiness to your loved ones.

We believe that our Silicone Prostheses will provide confidence, pride, comfort and reliability to amputees.

Each Regal Silicone Prosthesis is handmade and skillfully crafted with expertise and care. Some of our experienced technicians are also amputees and they understand very well how amputees would feel. All our Silicone Prostheses are inspected and have to comply with stringent internal standards before delivery.

At Regal, meeting CE and ISO requirements is just the starting point of our commitment to the quality. We strive to find solutions for amputees and continuously exceed customer expectations and satisfaction.

Features and Benefits?

- Flexibility: Wide variety of standardized sizes, hand styles and 36 colors to choose from;
- Adaptability: With extra Options such as Aesthetics and Surface Enhancement and Adaptation to residual limb and many other Cosmesis and Practical Options, our Silicone Prostheses are fabricated to suit different kind of needs of the amputees;
- Material advantage: The Silicone material we use are toxicity and flammability tested in Germany according to ISO standards and have been used for more than 18 years. Unlike other materials, the Silicone material is in itself stain-resistant, easy to clean with soap and water and is more elastic than PVC material.
- 12 months limited warranty*

*Please refer to "Warranty Policy" on page 154-155

Product Overview



100L

Silicone Myo glove:
Model 100L / 100
Page 28-29



100

Silicone Myo glove
(Pediatric):
Model 100PL
Page 30



100PL



Silicone Prosthetic glove:
Model 101L, 102L, 102LS
101LL, 102LL, 102LSL
Page 48



Silicone Child crawling hand:
Model CH
Page 51



Silicone Partial hand glove:
Model 103
Page 49



Silicone Prosthetic finger:
Model 200
Page 50

Silicone Footcover:

Model HDSFHT-ER / HDSFHT Page 104
Model HDSF-ER / HDSF Page 105



Silicone Prosthetic toe: Model TOE Page 106-107



Silicone Prosthetic arm sleeve: Model SL Page 138-139



Silicone maxillofacial prostheses Page 142

Silicone Prosthetic leg sleeve: Model BKSL Page 140-141

Regal Silicone Prostheses

Regal Silicone Prostheses are divided into two categories:



Different Models, Sizes, Sides, Color and Options are available for both categories

Ready Made

Characteristics of Ready Made Silicone Prostheses:

- Different Models and Sizes available
- 36 colors
- Optional features available

- **Available Models: All**

Semi-Custom Made (SCM)

- **What is SCM? (Product Code: SCM)**

SCM is a fabrication technique which requires high demand of expertise in molding forming and fabrication. SCM prosthesis provides a comfort fit to the residual limb.

- **Characteristics of SCM:**

- Adapt to the residual limb
- For amputated part, the appearance and dimension are similar to the chosen Ready Made glove size
- 36 colors
- Optional features available

- **When do we need SCM?**

When the dimension of the residual limb falls outside our Ready Made glove size, for example, if patient chooses the size M but the dimension of the residual limb closes to size L or if the patient has chosen the right size and wishes to lengthen the fingers.

- **Available Models: All**

• Ready Made Silicone Prosthesis:

Step 1 Choose a Model

- Finger: Model 200 series (page 50)
- Partial hand: Model 103 (page 49)
- Wrist and above wrist: Model 101L, 102LS, 102L, 101LL (long), 102LSL (long), 102LL (long) (page 48)
- Arm sleeve: Model SL (page 138)
- Toe: Model TOE series (page 106-107)
- Partial foot: Model HDSFHT, HDSF (page 104-105)
- Leg sleeve: Model BKSL (page 140)



Step 2 Measure Palm Circumference and choose Size, Side and Color

- Measure Palm Circumference C1 of the sound hand then choose a few closest Sizes from Regal Size Measurement Chart. From the Sizes chosen, select the appearance that closely resemble to the sound hand. Note: some sizes are unisex.
- Choose Side and Color from Regal Color Sample.

Sample of Size Measurement Chart

For Model 101L, 102LS, 102L, 101LL, 102LSL, 102LL (wrist or above wrist amputation)																	
Male - gloves thickness: 2-2.5mm					Female - gloves thickness: 2-2.5mm												
OttoBock gloves	Regal gloves	(mm)			Standard length	Long length	Standard length	Long length	Standard length	Long length							
		C1	C3	C11	L5	E	F										
854-230x92L	XL Left	235	198	80	74	310	544	P.54	855-200x89L	XL Left	220	183	79	76	314	535	P.64
854-244x94R	XL Right	239	210	84	76	310	538	P.54	855-210x89R	XL Right	223	183	76	80	323	536	P.64
854-228x88L	XL1 Left	233	196	82	73	395	538	P.56	-	L Left	205	179	72	67	297	487	P.82
854-228x84L									-	L Right	206	179	71	65	290	487	P.82
854-228x89R	XL1 Right	230	194	77	77	373	530	P.56	Adult								
854-225x82R									855-195x78L	L1 Left	202	170	66	74	315	532	P.70
854-225x84R									855-195x78R	L1 Right	203	174	64	71	319	532	P.70
854-232x94L	L Left	250	190	74	78	320	533	P.58	855-192x78L	L2 Left	202	174	72	70	313	476	P.84
854-230x93R	L Right	241	196	75	77	318	530	P.58	855-200x79R	L2 Right	203	174	72	67	310	460	P.84
-	L1 Left	220	193	76	67	355	556	P.60									
-	L1 Right	233	200	81	66	336	550	P.60									
-	L2 Left	228	187	73	76	370	545	P.62									
-	L2 Right	229	197	77	76	373	546	P.62									



Step 3 Choose Options

Aesthetics and Surface Enhancement:

- Dual Coloring / Custom Coloring (page 14)
- X series (page 16)
- Acrylic Nails (page 17)
- Smooth Coating (page 19)

Structural Changes:

- Wrist Connector (page 20)
- Custom Filling (page 21)
- Fingers construction (page 23)
- Zipper (page 25)
- Glue To Socket (page 25)

• Semi-Custom Made (SCM) Silicone Prosthesis:

Step 1 Same procedure as Ready Made Silicone Prosthesis

- see Step 1, 2 and 3 from the previous page



Step 2 Complete SCM order form

- Form S1: Model 103 Partial hand
- Form S2: Model 101L, 102L, 102LS, 101LL, 102LL, 102LSL, SL-29, SL-50 Wrist or Above wrist amputation & Arm Sleeve
- Form S3: Model 200C, 200S, 201, 202, 203, 204, 205 Finger amputation
- Form S4: Model HDSF, HDSF-ER, HDSFHT, HDSFHT-ER Partial Foot amputation
- Form S5: Model TOE Series
- Form S6: Model BKSL Leg Sleeve
- All forms can be downloaded from our website www.regalprosthesis.com

Step 3 Cast Taking

Collect information:

Cast Taking, Order Forms, Photos, and Color are required.

Please ask for further information for the Guideline on Cast Taking, How to Measure and Color Selection



Step 4 Trial Prosthesis

A Trial Prosthesis will be made when the information is completely collected. The Trial Prosthesis is fabricated with a single base color without any nail color and other shading. The Trial Prosthesis is to check both "Fit" and "Base Color". Where modification is required after the trial fitting, fill in the Trial Modification form and mark on the Trial Prosthesis and send us for Final Prosthesis fabrication.

Please ask for further information for the Guideline on Trial Modification

Note: The Trial Prosthesis is used strictly for the purpose of checking the fit and color. All Trial Prostheses will not be made in full nail color and shadings. There is no warranty for all Trial Prostheses see page 154-155.



Step 5 Final Prosthesis

Once the Trial Prosthesis is confirmed, Final Prosthesis will be fabricated according to the result of the Trial fitting. The Final Prosthesis will be fabricated with all the nail color and shading.

Regal Silicone Prostheses

- **Examples showing the difference between a Trial Prosthesis and a Final Prosthesis:**



Trial Prosthesis: Single base color, no nail color nor shading



Final Prosthesis with X series option



Trial Prosthesis: Single base color, no nail color nor shading



Final Prosthesis with X series option

- **Leadtime for SCM:**

Type of prosthesis	Leadtime
Trial prosthesis	14-21 working days
Final prosthesis	14 working days

Note: Leadtime is calculated after ALL INFORMATION IS COMPLETELY GIVEN

- **Examples of SCM:**

- **Partial hand amputation**



Partial hand residual limb



Without SCM, standard prosthesis is too small to fit the residual limb



With SCM, the prosthesis fits well to the residual limb

-Fingers amputation



Without SCM, the prostheses cannot fit onto the residual fingers, may impede blood circulation if used



With SCM, the prostheses fit well onto the residual fingers

-Partial foot amputation



Without SCM, the prosthesis cannot fit onto the residual limb



With SCM, the prosthesis fits well onto the residual limb

-Ear prosthesis



Silicone ear prosthesis: SCM (Semi-Custom Made)

Optional Features:

Varieties of Options can be chosen for both Ready Made and SCM Silicone Prostheses:

- Aesthetics and Surface Enhancement and
- Structural Changes

Options: Aesthetics and Surface Enhancement

This Option offers you Aesthetics and Surface enhancement on top of the Silicone Prostheses you have chosen. With this option, the patient can choose one or more of the following:

- **Color** (page 14): This includes Dual Coloring and Custom Coloring.
- **X Series** (page 16): Nails are made to be more aesthetic looking, and hairs on each fingers are added upon request.
- **Acrylic Nails** (page 17): French manicure style Acrylic Nails are carefully trimmed and adhered onto each fingers.
- **Smooth Coating** (page 19): Smooth Coating lowers the coefficient of friction of the Silicone Prostheses thus allows patient to slide on the clothes easily.

Options: Structural Changes

This Option offers you the Structural Changes on top of the Silicone Prostheses you have chosen. The Option changes the functionality and durability of the fingers, internal filling construction (passive inner hand) and the adaptation to the residual limb. Patient can choose one or more of the following:

- **Wrist Connector** (page 20): M12x1.5 (Internal / External) or 1/2"-20 (Internal / External) are available
- **Custom Filling** (page 21): The shape of the passive inner hand filling and the type of the filling material can be chosen to ensure the conformity to the residual limb.
- **Fingers construction** (page 23): Wired Fingers and Hinged Fingers allow patient to bend the fingers. Reinforced fingers provide durability to each fingers.
- **Zipper** (page 25): Plastic zipper can be added for specific Models to allow easy donning and doffing.
- **Glue To Socket** (page 25): A value added service in which our well-experienced technicians trim, thin and adhere the Silicone Prostheses onto the patient's prosthetic socket. The entire prosthesis is then ready-to-use.

Options: Aesthetics and Surface Enhancement

This Option allows patients to enhance their Silicone Prostheses by altering the appearance of their prostheses. Examples include: Dual Coloring, Custom Coloring, Acrylic Nails, Smooth Coating. Additional costs apply to all Options.

Option: Color

Description and applications:

We have 36 standard colors to select for your patient's skin tone. Please use only Regal color samples for better color matching.

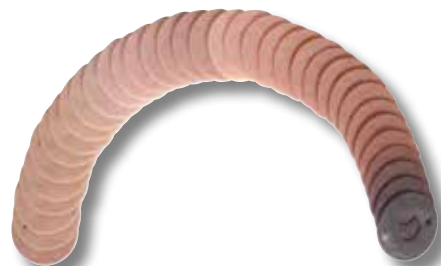

- 36 standard colors from Regal color samples:
 - A1 / A1-A2 / A2 / A2-A3 / A3 / A3-A4 / A4
 - 1 / 1-2 / 2 / 2-3 / 3 / 3-4 / 4 / 4-5 / 5 / 5-6 / 6 / 6-7 / 7 / 7.25 / 7-8 / 8 / 8-9 / 9
 - C0 / C0-C1 / C1 / C1-C2 / C2 / C2-C3 / C3 / C3-C4 / C4 / C4-C5 / C5

Option: Dual Coloring and Custom Coloring

Description and applications:

On top of the 36 standard colors, patient may choose Dual Coloring or Custom Coloring:

- **Dual Coloring** (Product Code example: D2P1 (Dorsal color 2, Palmar color 1))
 - Two colors from Regal color sample can be selected for the dorsal and palmar / plantar sides
 - Photos of the transition line are required to be sent for fabrication
- **Custom coloring** (Product Code: CC)
 - We can also custom mix your color, below samples are required to be sent to us for fabrication:
 - Color sample from previous prosthesis or from another manufacturer;
 - Photos of the patient's hands

Note: Since all our Silicone Prostheses are handmade, in Dual Coloring the transition line and the palmar / plantar sides may not be blended exactly according to patient's request. You may request for a Trial Prosthesis to be sent before making the Final Prosthesis. Additional cost is required for the Trial Prosthesis. Please ask for more details.

Please ask for further information for Guideline on Color Selection.

- Examples of Dual Coloring:



Upgrade Option

Myo-Electric & Mechanical Gloves

Gloves, Passive & Partial Hands, Digits

Footcovers

Leg / Arm Sleeve
Maxillofacial / Accessories

FAQ & Warranty

Option: ~~X~~ Series

Upgrade Option

Myo-Electric & Mechanical Gloves

Gloves, Passive & Partial Hands, Digits

Footcovers

Leg / Arm Sleeve
Maxillofacial / Accessories

FAQ & Warranty

2D: Hair layflat

3D



Hair implant on each fingers 2D / 3D



Additional Shading



Enhanced Nails (more natural looking)

Description and applications:

- Nails are enhanced to more natural looking;
- Supplemental shading is subtly added to each fingers;
- Hairs of each finger are integrated into each finger.

(Product Code: X)

Option: Acrylic Nails



Regular Silicone Nails



Acrylic Nails



Description and applications:

- French manicure style Acrylic Nails are carefully trimmed, grinded and adhered onto each Silicone Nails to allow nail polishing.
- Available Glove Models: 101L, 101LL, 102LS, 102LSL, 102L, 102LL, 103, 200 series
Available Sizes: Female XL, L, L1, L2, LM, LM1, M, MS, MS2, S, S1, CL, CM, CM1, CS, CS1
- Available Footcover Models: HDSFHT, HDSFHT-ER, HDSF, HDSF-ER, TOE series
Available Sizes: 16, 16.5, 17, 18, 19, 20, 21, 22, 23, 23.5, 24, 25, 26, 27, 28cm

(Product Code: ACRN)

Note: All Acrylic Nails are covered by limited warranty, see page 154-155

- Length of Acrylic Nails

Acrylic Finger Nails



Sizes of Female Gloves and Fingers	Thumb	Index	Middle	Ring	Little
XL	16	14	15	15	13
L	16	14	14	14	11
L1	16	6	8	6	10
L2	16	14	13	13	10
LM	16	13	14	14	11
LM1	15	14	15	13	11
M	15	14	13	13	10
MS	13	11	13	12	9
MS2	16	14	14	13	11
S	16	14	14	11	10
S1 / CL	17	13	14	13	12
CM	15	13	14	11	9
CM1	15	14	15	14	11
CS	13	7	10	8	6
CS1	14	10	10	9	8

Acrylic Toe Nails



Sizes of Silicone Footcovers	Big Toe	2nd Toe	3rd Toe	4th Toe	5th Toe
28cm	17	8	7	6	4
27cm	11	8	8	6	4
26cm	15	8	8	6	4
25cm	12	6	6	5	4
24cm	11	7	7	6	5
23.5cm	11	8	6	5	4
23cm	15	7	7	6	6
22cm	13	7	5	4	4
21cm	13	7	5	4	4
20cm	12	6	6	5	4
19cm	12	7	7	5	4
18cm	11	6	5	5	4
17cm	13	7	7	6	5
16.5cm	13	7	6	6	5
16cm	11	6	6	6	5

Option: Smooth Coating

Description and applications:

With the Smooth Coating Option, a layer of Smooth Coating is applied onto the Silicone Prosthesis. The Smooth Coating has the following features:

- **Abrasive resistance**
Smooth Coating protects the Silicone Prosthesis by lowering its coefficient of friction, thus the Silicone Prosthesis may last longer against rubbing action than without the Smooth Coating.
- **Reduce surface tackiness**
With the Smooth Coating, patient can slide on clothes on easily.

(Product code: SC)



Note: - Smooth Coating has a thin milky-white finish. The resulting base color of the Silicone Prostheses may be slightly lighter;

- *To maintain the Smooth Coating, any dirt or ink must be cleaned immediately with mild detergent and warm water. The Smooth Coating will absorb oil based ink quickly and cannot be cleaned once absorbed.*
- *Smooth Coating is subjected to wear and tear.*
- *Smooth Coating is not covered by warranty, see page 154-155*

Options: Structural Changes

This Option allows patient to Structurally Change the Silicone Prosthesis to achieve its practical purpose. Structural Changes include the change of the functionality and durability of the fingers, internal filling construction and the adaptation to the residual limbs or the prosthetics sockets. Additional costs apply.

Option: Wrist Connector

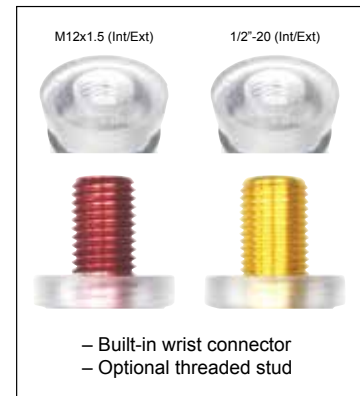

Passive inner foam hand with Wrist Connector inside Model 102LS and 102LSL

Description and applications:

- Passive inner hand, built-in Wired Fingers and wrist connector are equipped in Model 102LS and 102LSL as a standard feature of our Silicone Prosthetic glove. The function is to connect the Silicone Prosthesis to the prosthetic arm socket.
- Four types of wrist connector:
 - External M12x1.5 (Red) threaded stud (Product Code: EX-MT);
 - External 1/2"-20 (Gold / Gold tip) threaded stud (Product Code: EX-IP);
 - Internal M12x1.5 (Red) threaded stud (Product Code: IN-MT);
 - Internal 1/2"-20 (Gold / Gold tip) threaded stud (Product Code: IN-IP)

Note: Default configuration is External M12x1.5 Threaded Stud (Red) (Product Code: EX-MT)

Option: Custom Filling

Description and applications:

Custom Filling option is to fill up the cavity of the Regal Silicone Prosthesis as the replacement of the amputated area. Resulting shape of the filling conforms to the residual limb to achieve a comfortable fit. Custom Filling material can be Foam, Silicone and "Foam and Silicone". The choice of the material depends on the filling volume and hygienic purpose.

- **Foam Filling** (Product Code: F)
Light and flexible.
- **Silicone Filling** (Product Code: S)
Wear resistant and can be cleaned easily. Where the filling volume is small such as half of a finger, Silicone Filling is recommended for durability purpose.
- **Foam and Silicone Filling** (Product Code: F+S)
The amputated area of the Silicone Prosthesis is firstly filled by Foam then sealed with Silicone. This combination is light weight and hygienic. Recommend to use where the volume of the amputated area is large such as partial foot or hand to reduce weigh.

Available Models: 102L, 102LL, 103, HDSFHT, HDSFHT-ER, HDSF, HDSF-ER, 200 series. (For TOE series, only the Silicone Filling option is available)

Note: To achieve comfortable fit, an accurate cast provided by customer must be required. Please ensure that the cast measurements and the order form measurements match each other before sending out the casts. For partial foot, it is important to mark the Anterior, Posterior, Medial and Lateral alignment line on the cast. These lines will determine the accuracy of the Custom Filling.

Please ask for further information for the Guideline on Cast Taking, How to Measure and Trial Modification

• Examples of Custom Foam Filling:



Fingers with Custom Foam Filling



Partial hands with Custom Foam Filling

- Examples of Custom Foam Filling:



Partial hands (long) with Custom Foam Filling



Wrist disarticulation with Custom Foam Filling



Toes with Custom Foam Filling



Partial foot with Custom Foam Filling



Partial foot (short) with Custom Foam Filling



Upgrade Option

Myo-Electric & Mechanical Gloves

Gloves, Passive & Partial Hands, Digits

Footcovers

Leg / Arm Sleeve
Maxillofacial / Accessories

FAQ & Warranty

Option: Fingers Construction

Description and applications:

- **Wired Fingers** (Product Code: W)
Metal wiring is wrapped by foam filling inside the fingers allowing patients to bend the fingers to attain the natural look they desire. Plastic protection caps at the fingertips protect against wires piercing through the Silicone Prostheses. The Wired Fingers are designed for palm and above amputation. Wired Fingers are available in these Models: 102L, 102LL, 102LS, 102LSL (Standard) and 103 (Option with no extra cost).

Note: For Model 103 partial hand amputation, Wired Fingers can be chosen depending on the length of the residual limb, i.e. if there is enough room for wiring.



- **Hinged Fingers** (Product Code: HF)
Where patients with limited or reduced manual dexterity may have difficulty in bending them, the Hinged Fingers are recommended. Articulated finger joints with hinges allow the patients to bend the first and second phalanges of each finger at desired angle. Hinged Fingers are easier to bend and look more realistic than the Wired Fingers when bending.
Available Models: 102L, 102LL, 102LS, 102LSL, 103 and 200 series
(Option with extra cost)
Available Sizes: All except for Male CS, CXS and Female CS, CS1, CXS

Note: Depending on the length of the residual limbs, the Hinged Fingers can be chosen to be with only one or two hinges.

Please ask for further information for Guidelines on Wired and Hinged Fingers



Regal Silicone Prostheses

Upgrade Option

Myo-Electric & Mechanical Gloves

Gloves, Passive & Partial Hands, Digits

Footcovers

Leg / Arm Sleeve
Maxillofacial / Accessories

FAQ & Warranty

- Reinforced Fingers** (Product Code: RF)
 - Layers of reinforced fabric are embedded inside the fingers, providing extra durability
 - Available Models: 100/100L (Standard), 102L, 102LL, 102LS, 102LSL (Option)
 - Available Sizes: ALL except for Male CM, CS, CXS and Female S1, CL, CM, CS, CXS

Reinforced Finger (RF) is NOT AVAILABLE in conjunction with: Hinged Fingers (HF) and Semi-Custom Made (SCM) options

Note: Fingers with Reinforced Finger (RF) may be larger in circumference.

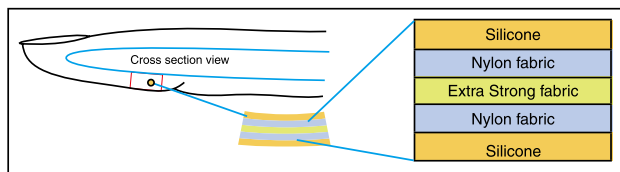

Reinforced area on Regal Silicone Prostheses			
	From metacarpal joint to glove margin	First 3 fingers	All fingers (Level 3 option)
Model 100PL	2 layers of reinforcement fabric	1 layer of strong reinforcement fabric	-
Model 100, 100L	2 layers of reinforcement fabric	3 layers of strong reinforcement fabric	-
Model 101L, 101LL, 102L, 102LL, 102LS, 102LSL	2 layers of reinforcement fabric	-	3 layers of strong reinforcement fabric
Model 103	2 layers of reinforcement fabric	-	-
Model 200	-	-	-
Single fingers / Toes	-	-	-
Model HDSFHT, HDSFHT-ER, HDSF, HDSF-ER	Size 18-22cm: 3 layers of reinforcement fabric Size 23-28cm: 1 layer of reinforcement fabric + 1 layer of strong reinforcement fabric	-	-
Model BKSL, SL	2 layers of reinforcement fabric	-	-

- Preset Bent Shape** (Product Code: B1 / B2 / B3)
 - Must be ordered under SCM semi-custom made.
 - If a patient prefers not to have articulated fingers, but yet would like the fingers to have a preset bent shape, the patient can request this when choosing the Semi-Custom Made (SCM) Option, we will shape the finger prostheses according to the cast given.

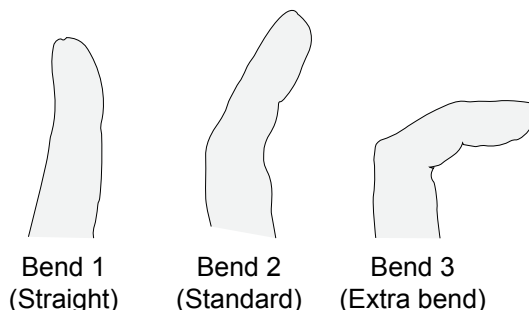

Option: Zipper

Description and applications:

- Zipper is used for easy donning and doffing. Plastic zippers are available as a Standard feature on the Partial Hands (Model 103) and on the Foot Covers (Model HDSFHT, HDSFHT-ER, HDSF, HDSF-ER) or as an Option on the gloves for Passive Hands (Model 101L, 101LL, 102L, 102LL, 102LS, 102LSL), Silicone Sleeve (Model SL) and Silicone Sleeve for Below Knee (Model BKSL).
- Zipper teeth that are used on the Foot Covers are larger than the other models for durability purpose. Smaller teeth that are used on other models are used to provide a close to seamless look to the Silicone Prostheses.
- A fabric-reinforced silicone zipper tongue is integrated underneath each zipper to provide protection to the patient's residual limb. Zipper stop is positioned three teeth before the end to minimize the chance of falling off when repeated closing.

(Product Code: PZ)

Option: Glue To Socket

Description and applications:

With Glue To Socket Option, customers may send us the prosthetic socket, we will then trim, adhere, grind and finish the Silicone Prosthesis onto the prosthetic socket. The entire prosthesis will be ready to use once received

(Product Code: GTS)



Complete Product Structure (Lower Extremity)

- ✓ = Standard feature
- O = Optional feature (no extra cost)
- + = Optional feature (extra cost)

Complete Product Structure (List of all available features of each Model)		Models					
Specification	Product features description	Code	Silicone footcover	Silicone footcover (with carbon footplate)	Silicone Prosthetic toe	Silicone prosthetic leg sleeve	
Basic	Gender, Size		HDSFHT, HDSF	HDSFHT-ER, HDSF-ER	TOE	BKSL	
	Side	L / R	✓	✓	✓	✓	
	Color - Single (use color sample from Regal)		✓	✓	✓	✓	
	Carbon Fiber Footplate		✓	✓			
	Semi-Custom Made (p.7)						
Options: Aesthetics and Surface Enhancement	Color (p.14)	SCM	+	+	+	+	
	Dual Coloring (Dorsal / Palmar (use color sample from Regal))	D/P	+	+	+	+	
	Custom Coloring (color sample is required)	CC	+	+	+	+	
	X Series (p.16)	X	+	+	+	+	
	Nails, Hairs	- Hair Dimension (available only when selecting X series) - Hair Color (available only when selecting X series) BB (Brown-Black), BR (Brown), BL (Black)	2D / 3D BB/BR /BL	+	+	+	
Options: Structural Changes	Smooth Coating	ACRN	+	+	+	+	
	Smooth Coating (p.19)	SC	+	+	+	+	
	Wrist Connector (p.20)	- External threaded stud, Metric - Internal, Metric - External threaded stud, Imperial - Internal, Imperial	EX-MT IN-MT EX-IP IN-IP				
	Custom Filling (p.21)	- Foam - Silicone	F S	+	+	+	
	Fingers Con-struction (p.23)	- Foam and Silicone (available depends on the length of the residual limb p.21) Wired Fingers (with standard filling) Hinged Fingers (available depends on the size of Silicone Prostheses & the length of residual limb p.23) Reinforced Fingers (available to specified size) * fingers with RF may be larger in circumference * not available when selecting SCM option	F+S W HF RF	+	+	+	
Zipper	Fingers Bend (available only when selecting SCM) B1 (Straight), B2 (Standard), B3 (Extra Bend) Zipper (p.25) (plastic) Glue To Socket (p.25) (prosthetic socket is required)	B1/B2 /B3 PZ GTS	✓	✓		+	

Silicone Myo glove

Model 100L

Product descriptions:

- High definition silicone prosthetic gloves, detail handprints, veins and knuckles
- Design for fitting onto myo-electric and mechanical hand mechanism
- Long length design
- Reinforced finger tips
- Upgrade options: See our Complete Product Structure page 26

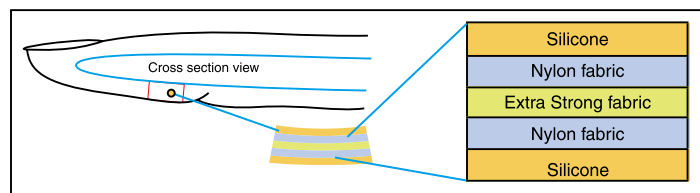

Applications:

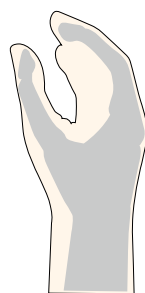

myo/mechanical hand

Size chart:

Adult				
Size	XL (8"-8¼")	L (7¾")	M (7¼")	S (7")
Male	P.32	P.34	P.36	P.42
Female	-	P.38	P.40	P.42

Silicone Myo glove

Model 100

Product descriptions:

- High definition silicone prosthetic gloves, detail handprints, veins and knuckles
- Design for fitting onto myo electric and mechanical hand mechanism
- Reinforced finger tips
- Upgrade options: See our Complete Product Structure page 26

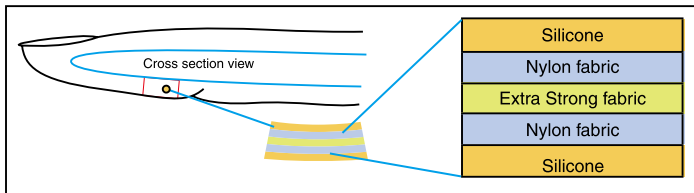

Applications:

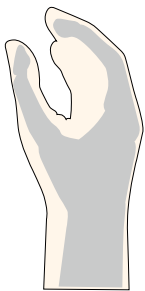

myo/mechanical hand

Size chart:

Adult				
Size	XL (8"-8¼")	L (7¾")	M (7¼")	S (7")
Male	P.32	P.34	P.36	P.42
Female	-	P.38	P.40	P.42

Silicone Myo glove (Pediatric)

Model 100PL



Product descriptions:

- For pediatric use
- High definition silicone prosthetic gloves, detail handprints and knuckles
- Design for fitting onto myo 2000 hand mechanism
- Upgrade options: See our Complete Product Structure page 26

Size chart:

Pediatric				
Size	PL (6 1/2")	PM (6")	PS (5 1/2")	PXS (5")
Unisex	P.44	P.44	P.46	P.46

Regal silicone prosthetic gloves - Size measurement chart

Measure Palm Circumference **C1** of the sound hand then choose a few closest Sizes from Regal Size Measurement Chart. From the Sizes chosen, select the appearance that closely resemble to the sound hand.

Note: some sizes are unisex.

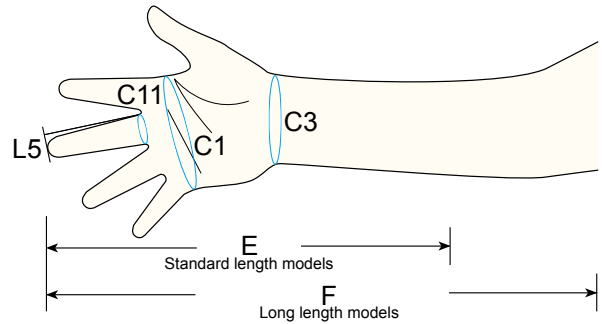

How to measure : See page 147

Model 100L (for myo / mechanical hand mechanism)

Male - gloves thickness: 2-3.5mm									Female - gloves thickness: 2-3.5mm										
OttoBock gloves	Regal gloves		(mm)				Standard length	Long length	Catalogue 2015 page	OttoBock gloves	Regal gloves		(mm)				Standard length	Long length	Catalogue 2015 page
			C1	C3	C11	L5							E	F	C1	C3			
8S4=220x80L	XL(8"-8¼")	Left	236	198	76	78	-	555	P.32	8S5=195x78L	L(7¼")	Left	208	186	72	75	-	515	P.38
8S4=220x80R	XL(8"-8¼")	Right	233	203	75	78	-	560	P.32	8S5=195x78R	L(7¼")	Right	205	187	72	75	-	520	P.38
8S4=210x78L	L(7¼")	Left	208	185	68	74	-	565	P.34	-	M(7¼")	Left	198	176	64	75	-	480	P.40
8S4=210x78R	L(7¼")	Right	208	190	72	75	-	555	P.34	-	M(7¼")	Right	202	180	66	75	-	475	P.40
8S4=190x76L	M(7¼")	Left	201	180	65	75	-	540	P.36	-	S(7")	Left	178	170	62	61	-	435	P.42
8S4=190x76R	M(7¼")	Right	201	180	70	74	-	537	P.36	-	S(7")	Right	178	170	63	62	-	435	P.42
-	S(7")	Left	178	170	62	61	-	435	P.42										
-	S(7")	Right	178	170	63	62	-	435	P.42										

The above information is for reference only. Please contact our technicians if you are not sure which size to choose.

Model 100 (for myo / mechanical hand mechanism)

Male - gloves thickness: 2-3.5mm									Female - gloves thickness: 2-3.5mm										
OttoBock gloves	Regal gloves		(mm)				Standard length	Long length	Catalogue 2015 page	OttoBock gloves	Regal gloves		(mm)				Standard length	Long length	Catalogue 2015 page
			C1	C3	C11	L5							E	F	C1	C3			
8S4=220x80L	XL(8"-8¼")	Left	233	200	75	80	345	-	P.32	8S5=195x78L	L(7¼")	Left	210	186	72	76	230	-	P.38
8S4=220x80R	XL(8"-8¼")	Right	230	205	73	78	350	-	P.32	8S5=195x78R	L(7¼")	Right	210	188	72	75	230	-	P.38
8S4=210x78L	L(7¼")	Left	222	192	73	73	215	-	P.34	-	M(7¼")	Left	195	174	61	73	220	-	P.40
8S4=210x78R	L(7¼")	Right	215	195	70	75	215	-	P.34	-	M(7¼")	Right	202	182	66	75	220	-	P.40
8S4=190x76L	M(7¼")	Left	202	178	65	75	220	-	P.36	-	S(7")	Left	178	170	62	61	230	-	P.42
8S4=190x76R	M(7¼")	Right	202	180	72	75	225	-	P.36	-	S(7")	Right	178	170	63	62	230	-	P.42
-	S(7")	Left	178	170	62	61	230	-	P.42										
-	S(7")	Right	178	170	63	62	230	-	P.42										

The above information is for reference only. Please contact our technicians if you are not sure which size to choose.

Model 100PL (for pediatric myo 2000 hand mechanism)

Unisex - gloves thickness: 2-2.5mm									
OttoBock gloves	Regal gloves		(mm)				Standard length	Long length	Catalogue 2015 page
			C1	C3	C11	L5			
-	PL(6½")	Left	165	153	53	72	-	473	P.44
-	PL(6½")	Right	168	155	53	72	-	473	P.44
-	PM(6")	Left	153	140	49	60	-	440	P.44
-	PM(6")	Right	155	141	48	60	-	440	P.44
-	PS(5½")	Left	143	131	48	47	-	400	P.46
-	PS(5½")	Right	141	131	48	47	-	400	P.46
-	PXS(5")	Left	133	123	45	43	-	390	P.46
-	PXS(5")	Right	133	121	45	43	-	390	P.46

The above information is for reference only. Please contact our technicians if you are not sure which size to choose.

Regal Silicone Prostheses

Product: Silicone myo glove

Model: 100L, 100

Size: Male, XL(8" - 8¼")



- ✓ = Standard feature
- O = Optional feature (no extra cost)
- + = Optional feature (extra cost)

Upgrade Option

Myo-Electric & Mechanical Gloves

Gloves, Passive & Partial Hands, Digits

Footcovers

Leg / Arm Sleeve Maxillofacial / Accessories

FAQ & Warranty

Product Structure (List of all available features of each Model and Size)

Product features description			Code	Models		
Basic Spec	Gender, Size		M-XL	✓		
	Side		L / R	✓		
	Color - Single (use color sample from Regal)			✓		
	Semi-Custom Made (p.7)		SCM			
Options: Aesthetics and Surface Enhancement	Color (p.14)	Dual Coloring Dorsal / Palmar (use color sample from Regal)	D/P	+		
		Custom Coloring (color sample is required)	CC	+		
	Nails, Hairs	X Series (p.16)		X	+	
		- Hair Dimension (available only when selecting X series)	2D / 3D		+	
		- Hair Color (available only when selecting X series) BB (Brown-Black), BR (Brown), BL (Black)	BB/BR /BL		+	
		Acrylic Nails (p.17)		ACRN		
	Smooth Coating	Smooth Coating (p.19)		SC	+	
Options: Structural Changes	Wrist Connector (p.20)	- External threaded stud, Metric		EX-MT		
		- Internal, Metric		IN-MT		
		- External threaded stud, Imperial		EX-IP		
		- Internal, Imperial		IN-IP		
	Custom Filling (p.21)	- Foam		F		
		- Silicone		S		
		- Foam and Silicone	(available depends on the length of the residual limb p.21)	F+S		
	Fingers Construction (p.23)	Wired Fingers	(with filling)	(available depends on the size of Silicone Prostheses & the length of residual limb p.23)	W	✓
		Hinged Fingers			HF	
		Reinforced Fingers * fingers with RF may be larger in circumference * not available when selecting SCM option			RF	✓
		Fingers Bend (available only when selecting SCM) B1 (Straight), B2 (Standard), B3 (Extra Bend)			B1/B2 /B3	
Zipper	Zipper (p.25) (plastic)		PZ			
	Glue To Socket (p.25) (prosthetic socket is required)		GTS			

How to order : See page 146

Please use the product codes from previous page.

Example:

100L - M - L - XL - 3	-	D3P2 - X - SC	-
Basic specification		Options: Aesthetics and Surface Enhancement	Options: Structural Changes

How to measure : See page 147

Male, XL(8"-8¼")

Model 100L (pg:28) Thickness: 2-3.5mm (mm)

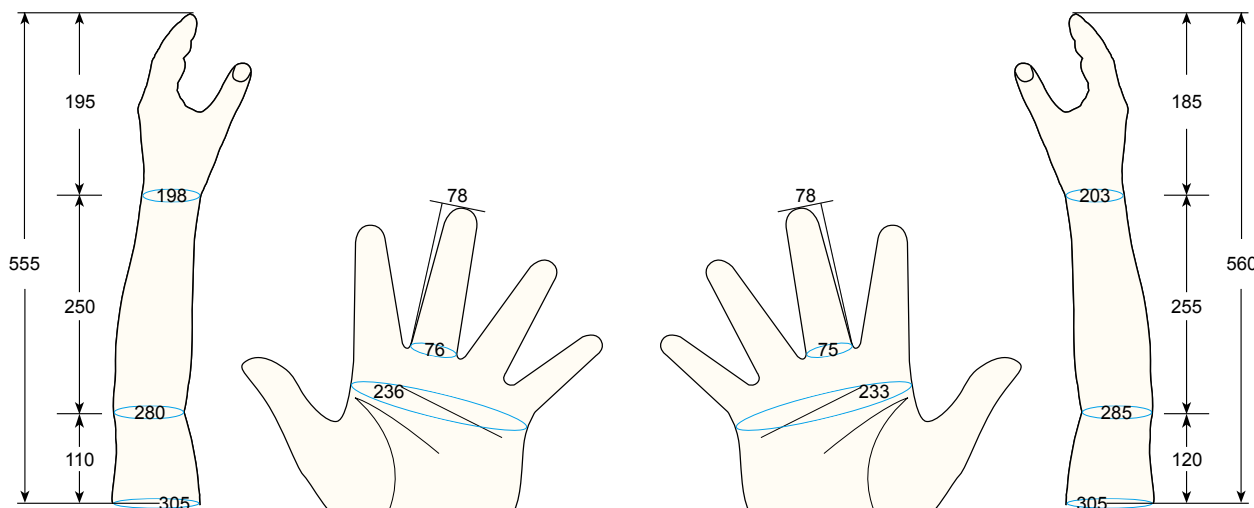

Model 100 (pg:29) Thickness: 2-3.5mm (mm)

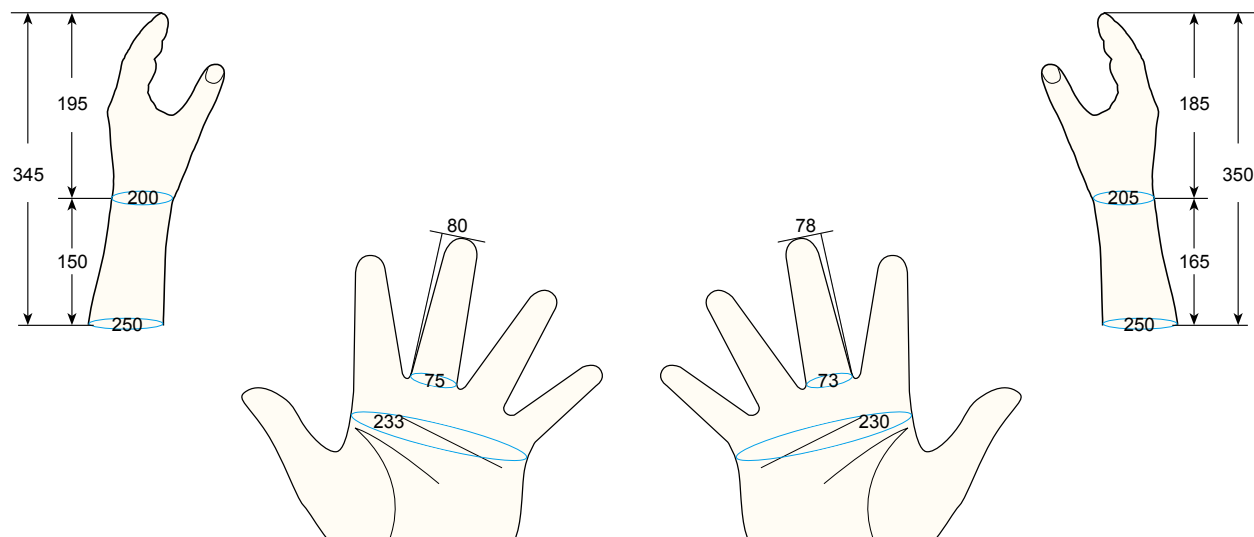

• All above information are for reference only •
• Please ask for more detail information •

Regal Silicone Prostheses

Product: Silicone myo glove

Model: 100L, 100

Size: Male, L(7 3/4")



✓ = Standard feature
 O = Optional feature (no extra cost)
 + = Optional feature (extra cost)

Upgrade Option

Myo-Electric & Mechanical Gloves

Gloves, Passive & Partial Hands, Digits

Footcovers

Leg / Arm Sleeve Maxillofacial / Accessories

FAQ & Warranty

Product Structure (List of all available features of each Model and Size)

Product features description			Code	Models		
Basic Spec	Gender, Size		M-L	✓		
	Side		L / R	✓		
	Color - Single (use color sample from Regal)			✓		
	Semi-Custom Made (p.7)		SCM			
Options: Aesthetics and Surface Enhancement	Color (p.14)	Dual Coloring Dorsal / Palmar (use color sample from Regal)	D/P	+		
		Custom Coloring (color sample is required)	CC	+		
	Nails, Hairs	X Series (p.16)		X	+	
		- Hair Dimension (available only when selecting X series)	2D / 3D		+	
		- Hair Color (available only when selecting X series) BB (Brown-Black), BR (Brown), BL (Black)	BB/BR /BL		+	
		Acrylic Nails (p.17)		ACRN		
	Smooth Coating	Smooth Coating (p.19)		SC	+	
Options: Structural Changes	Wrist Connector (p.20)	- External threaded stud, Metric		EX-MT		
		- Internal, Metric		IN-MT		
		- External threaded stud, Imperial		EX-IP		
		- Internal, Imperial		IN-IP		
	Custom Filling (p.21)	- Foam		F		
		- Silicone		S		
		- Foam and Silicone	(available depends on the length of the residual limb p.21)	F+S		
	Fingers Construction (p.23)	Wired Fingers	(with filling)	(available depends on the size of Silicone Prostheses & the length of residual limb p.23)	W	✓
		Hinged Fingers			HF	
		Reinforced Fingers * fingers with RF may be larger in circumference * not available when selecting SCM option			RF	✓
Fingers Bend (available only when selecting SCM) B1 (Straight), B2 (Standard), B3 (Extra Bend)			B1/B2 /B3			
Zipper	Zipper (p.25) (plastic)		PZ			
	Glue To Socket (p.25) (prosthetic socket is required)		GTS			

How to order : See page 146

Please use the product codes from previous page.

Example:

100L - M - L - L - 3	-	D3P2 - X - SC	-
Basic specification		Options: Aesthetics and Surface Enhancement	Options: Structural Changes

How to measure : See page 147

Male, L(7 3/4")

Model 100L (pg:28) Thickness: 2-3.5mm (mm)

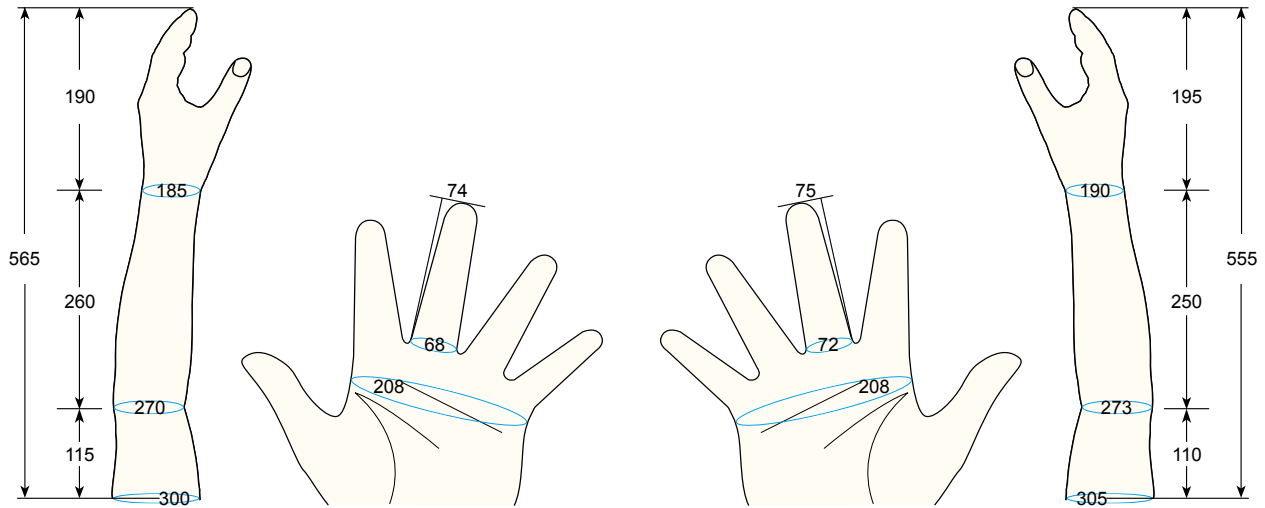

Model 100 (pg:29) Thickness: 2-3.5mm (mm)

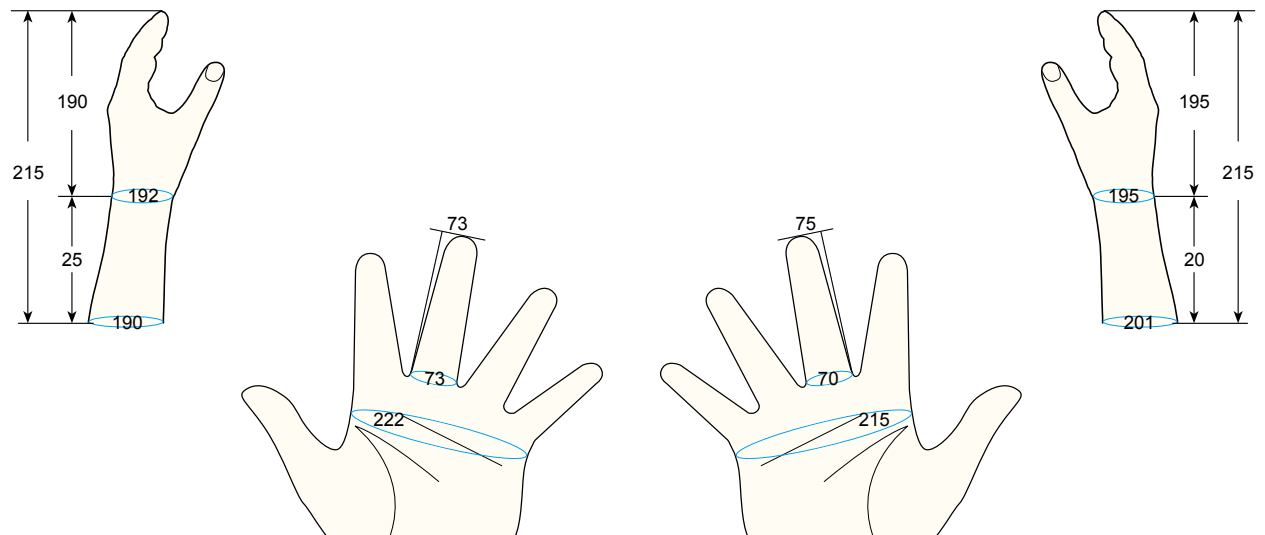

• All above information are for reference only •
• Please ask for more detail information •

Regal Silicone Prostheses

Upgrade Option

Myo-Electric & Mechanical Gloves

Gloves, Passive & Partial Hands, Digits

Footcovers

Leg / Arm Sleeve Maxillofacial / Accessories

FAQ & Warranty

Product: Silicone myo glove

Model: 100L, 100

Size: Male, M(7 1/4")



- ✓ = Standard feature
- O = Optional feature (no extra cost)
- + = Optional feature (extra cost)

Product Structure (List of all available features of each Model and Size)

Product features description			Code	Models		
Basic Spec	Gender, Size		M-M	✓		
	Side		L / R	✓		
	Color - Single (use color sample from Regal)			✓		
	Semi-Custom Made (p.7)		SCM			
Options: Aesthetics and Surface Enhancement	Color (p.14)	Dual Coloring Dorsal / Palmar (use color sample from Regal)	D/P	+		
		Custom Coloring (color sample is required)	CC	+		
	Nails, Hairs	X Series (p.16)		X	+	
		- Hair Dimension (available only when selecting X series)	2D / 3D		+	
		- Hair Color (available only when selecting X series) BB (Brown-Black), BR (Brown), BL (Black)	BB/BR /BL		+	
		Acrylic Nails (p.17)		ACRN		
	Smooth Coating	Smooth Coating (p.19)		SC	+	
Options: Structural Changes	Wrist Connector (p.20)	- External threaded stud, Metric		EX-MT		
		- Internal, Metric		IN-MT		
		- External threaded stud, Imperial		EX-IP		
		- Internal, Imperial		IN-IP		
	Custom Filling (p.21)	- Foam		F		
		- Silicone		S		
		- Foam and Silicone	(available depends on the length of the residual limb p.21)	F+S		
	Fingers Construction (p.23)	Wired Fingers	(with filling)	(available depends on the size of Silicone Prostheses & the length of residual limb p.23)	W	✓
		Hinged Fingers			HF	
		Reinforced Fingers * fingers with RF may be larger in circumference * not available when selecting SCM option			RF	✓
		Fingers Bend (available only when selecting SCM) B1 (Straight), B2 (Standard), B3 (Extra Bend)			B1/B2 /B3	
Zipper	Zipper (p.25) (plastic)		PZ			
	Glue To Socket (p.25) (prosthetic socket is required)		GTS			

How to order : See page 146

Please use the product codes from previous page.

Example:

100L - M - L - M - 3	-	D3P2 - X - SC	-
Basic specification		Options: Aesthetics and Surface Enhancement	Options: Structural Changes

How to measure : See page 147

Male, M(7 1/4")

Model 100L (pg:28) Thickness: 2-3.5mm (mm)

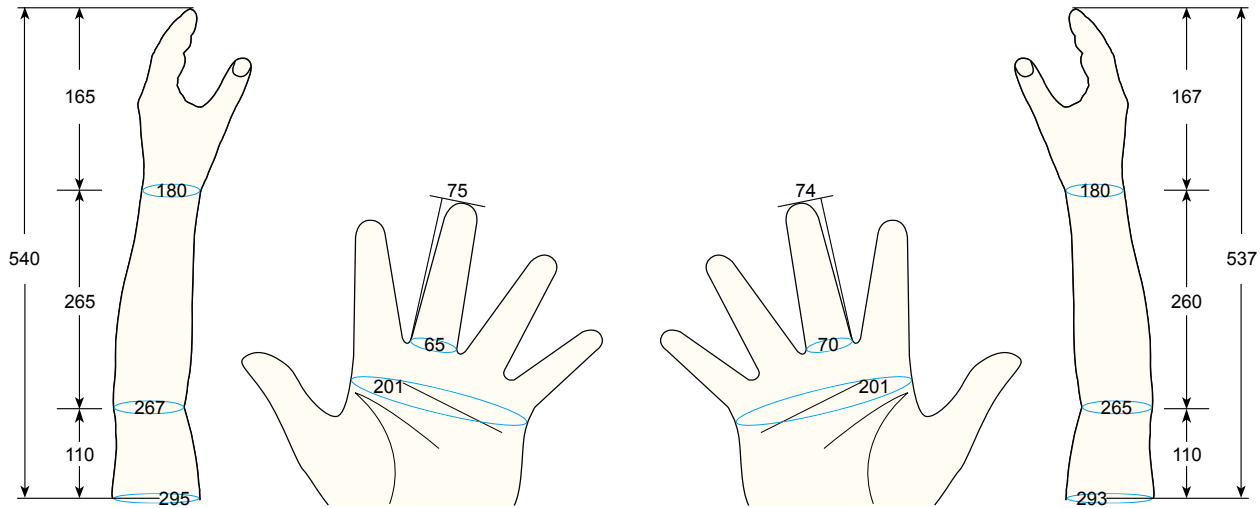

Model 100 (pg:29) Thickness: 2-3.5mm (mm)

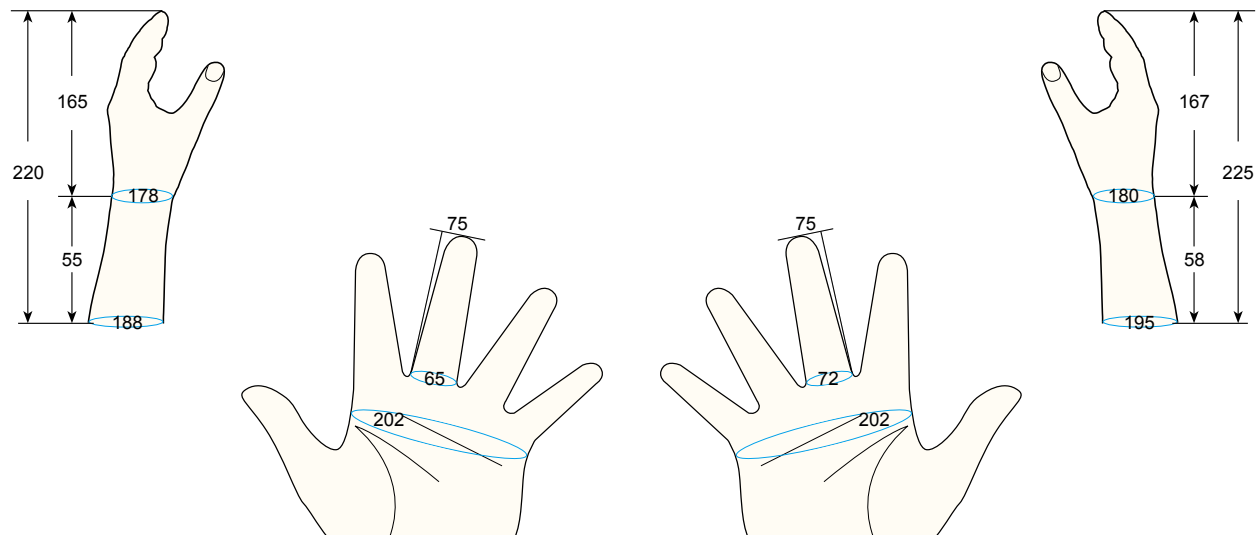

• All above information are for reference only •
• Please ask for more detail information •

Regal Silicone Prostheses

Product: Silicone myo glove

Model: 100L, 100

Size: Female, L(7 3/4")



- ✓ = Standard feature
- O = Optional feature (no extra cost)
- + = Optional feature (extra cost)

Upgrade Option

Myo-Electric & Mechanical Gloves

Gloves, Passive & Partial Hands, Digits

Footcovers

Leg / Arm Sleeve Maxillofacial / Accessories

FAQ & Warranty

Product Structure (List of all available features of each Model and Size)

Product features description			Code	Models		
Basic Spec	Gender, Size		F-L	✓		
	Side		L / R	✓		
	Color - Single (use color sample from Regal)			✓		
Semi-Custom Made (p.7)			SCM			
Options: Aesthetics and Surface Enhancement	Color (p.14)	Dual Coloring Dorsal / Palmar (use color sample from Regal)	D/P	+		
		Custom Coloring (color sample is required)	CC	+		
	Nails, Hairs	X Series (p.16)		X	+	
		- Hair Dimension (available only when selecting X series)	2D / 3D		+	
		- Hair Color (available only when selecting X series) BB (Brown-Black), BR (Brown), BL (Black)	BB/BR /BL		+	
		Acrylic Nails (p.17)		ACRN		
	Smooth Coating	Smooth Coating (p.19)		SC	+	
Options: Structural Changes	Wrist Connector (p.20)	- External threaded stud, Metric		EX-MT		
		- Internal, Metric		IN-MT		
		- External threaded stud, Imperial		EX-IP		
		- Internal, Imperial		IN-IP		
	Custom Filling (p.21)	- Foam		F		
		- Silicone		S		
		- Foam and Silicone	(available depends on the length of the residual limb p.21)	F+S		
	Fingers Construction (p.23)	Wired Fingers	(with filling)	(available depends on the size of Silicone Prostheses & the length of residual limb p.23)	W	✓
		Hinged Fingers			HF	
		Reinforced Fingers * fingers with RF may be larger in circumference * not available when selecting SCM option			RF	✓
Fingers Bend (available only when selecting SCM) B1 (Straight), B2 (Standard), B3 (Extra Bend)			B1/B2 /B3			
Zipper	Zipper (p.25) (plastic)		PZ			
	Glue To Socket (p.25) (prosthetic socket is required)		GTS			

How to order : See page 146

Please use the product codes from previous page.

Example:

100L - F - L - L - 3	-	D3P2 - X - SC	-
Basic specification		Options: Aesthetics and Surface Enhancement	Options: Structural Changes

How to measure : See page 147

Female, L(7 3/4")

Model 100L (pg:28) Thickness: 2-3.5mm (mm)

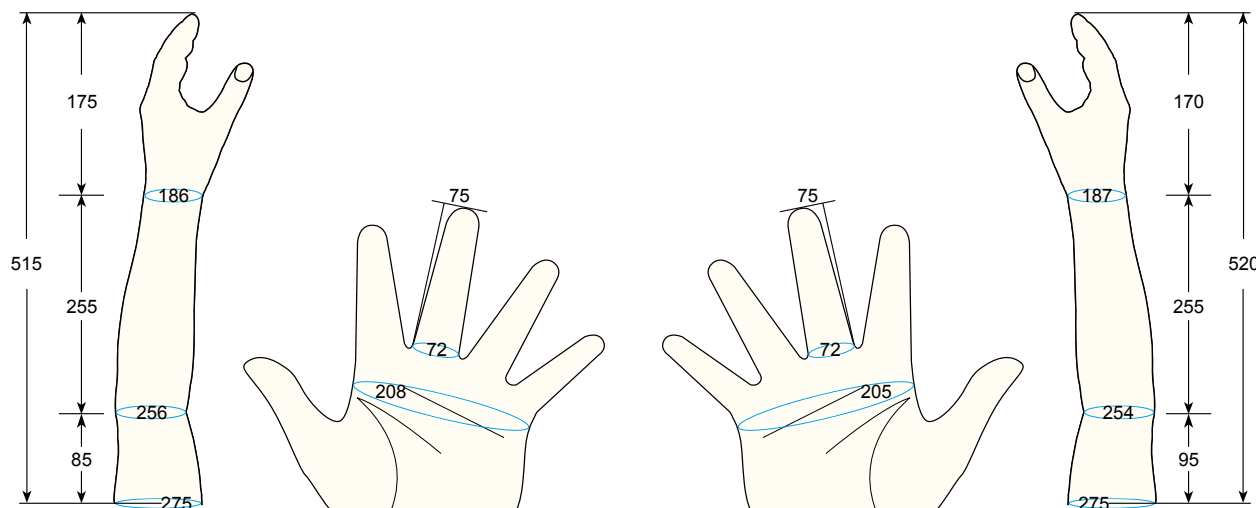

Model 100 (pg:29) Thickness: 2-3.5mm (mm)

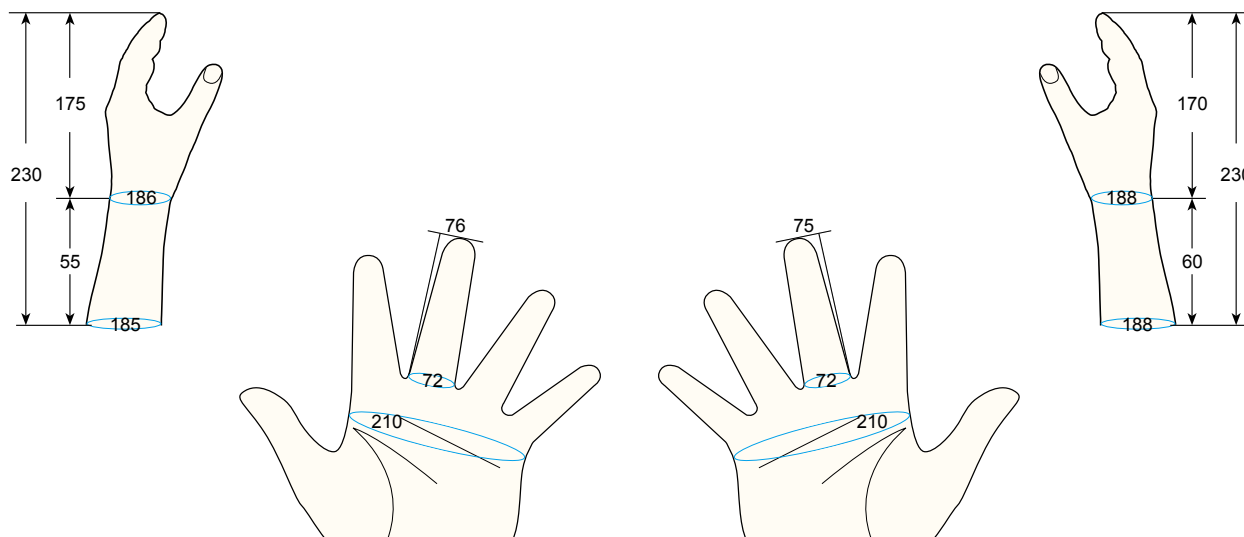

• All above information are for reference only •
• Please ask for more detail information •

Regal Silicone Prostheses

Product: Silicone myo glove

Model: 100L, 100

Size: Female, M(7 1/4")



✓ = Standard feature
 O = Optional feature (no extra cost)
 + = Optional feature (extra cost)

Upgrade Option

Myo-Electric & Mechanical Gloves

Gloves, Passive & Partial Hands, Digits

Footcovers

Leg / Arm Sleeve Maxillofacial / Accessories

FAQ & Warranty

Product Structure (List of all available features of each Model and Size)

Product features description			Code	Models		
Basic Spec	Gender, Size		F-M	✓		
	Side		L / R	✓		
	Color - Single (use color sample from Regal)			✓		
Semi-Custom Made (p.7)			SCM	+		
Options: Aesthetics and Surface Enhancement	Color (p.14)	Dual Coloring Dorsal / Palmar (use color sample from Regal)	D/P	+		
		Custom Coloring (color sample is required)	CC	+		
	Nails, Hairs	X Series (p.16)		X	+	
		- Hair Dimension (available only when selecting X series)	2D / 3D		+	
		- Hair Color (available only when selecting X series) BB (Brown-Black), BR (Brown), BL (Black)	BB/BR /BL		+	
		Acrylic Nails (p.17)		ACRN		
	Smooth Coating	Smooth Coating (p.19)		SC	+	
Options: Structural Changes	Wrist Connector (p.20)	- External threaded stud, Metric		EX-MT		
		- Internal, Metric		IN-MT		
		- External threaded stud, Imperial		EX-IP		
		- Internal, Imperial		IN-IP		
	Custom Filling (p.21)	- Foam		F		
		- Silicone		S		
		- Foam and Silicone	(available depends on the length of the residual limb p.21)	F+S		
	Fingers Construction (p.23)	Wired Fingers	(with filling)	(available depends on the size of Silicone Prostheses & the length of residual limb p.23)	W	✓
		Hinged Fingers			HF	
		Reinforced Fingers * fingers with RF may be larger in circumference * not available when selecting SCM option			RF	✓
Fingers Bend (available only when selecting SCM) B1 (Straight), B2 (Standard), B3 (Extra Bend)			B1/B2 /B3			
Zipper	Zipper (p.25) (plastic)		PZ			
	Glue To Socket (p.25) (prosthetic socket is required)		GTS			

How to order : See page 146

Please use the product codes from previous page.

Example:

100L - F - L - M - 3	-	D3P2 - X - SC	-
Basic specification		Options: Aesthetics and Surface Enhancement	Options: Structural Changes

How to measure : See page 147

Female, M(7 1/4")

Model 100L (pg:28) Thickness: 2-3.5mm (mm)

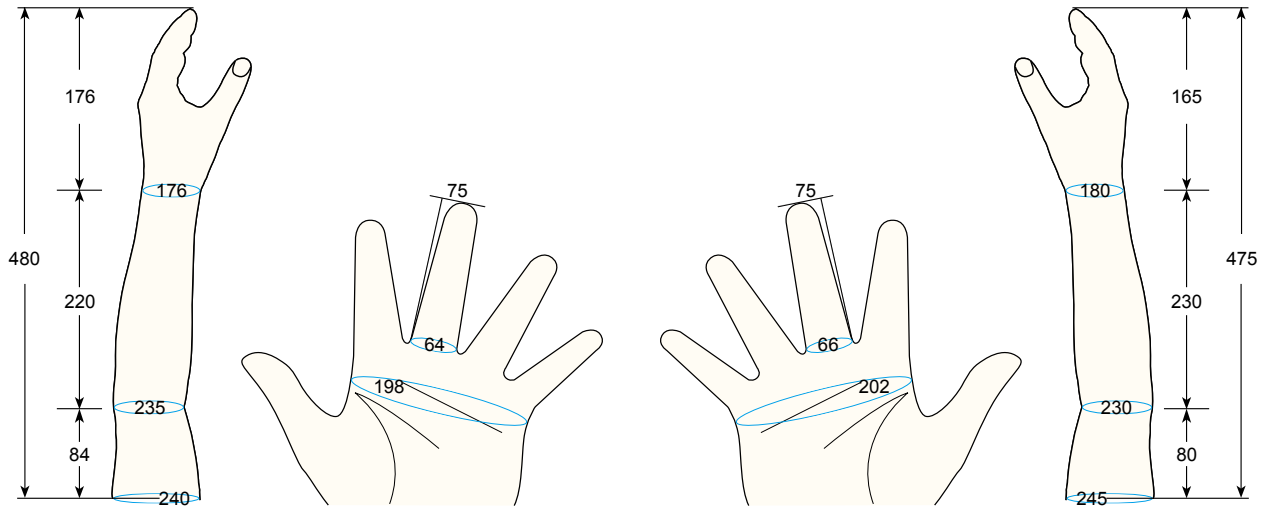

Model 100 (pg:29) Thickness: 2-3.5mm (mm)

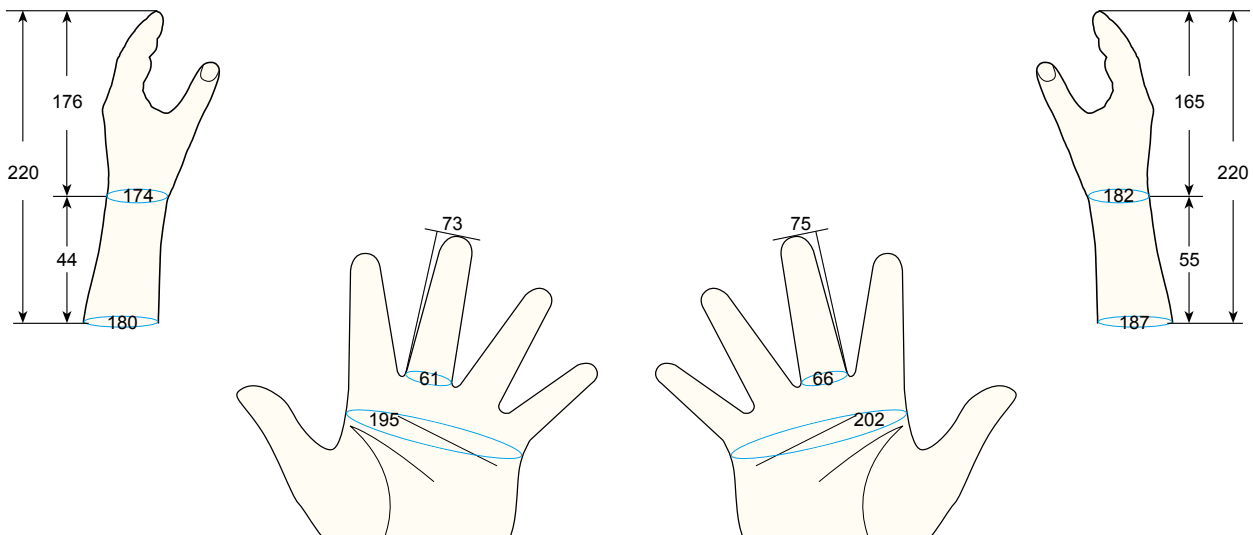

• All above information are for reference only •
• Please ask for more detail information •

Regal Silicone Prostheses

Product: Silicone myo glove

Model: 100L, 100

**Size: Male, S(7")
Female, S(7")**



✓ = Standard feature
O = Optional feature (no extra cost)
+ = Optional feature (extra cost)

Upgrade Option

Myo-Electric & Mechanical Gloves

Gloves, Passive & Partial Hands, Digits

Footcovers

Leg / Arm Sleeve Maxillofacial / Accessories

FAQ & Warranty

Product Structure (List of all available features of each Model and Size)

Product features description			Code	Models		
Basic Spec	Gender, Size (Code: M-S / F-S)			100L, 100		
	Side		L / R	✓		
	Color - Single (use color sample from Regal)			✓		
Semi-Custom Made (p.7)			SCM	+		
Options: Aesthetics and Surface Enhancement	Color (p.14)	Dual Coloring Dorsal / Palmar (use color sample from Regal)		D/P	+	
		Custom Coloring (color sample is required)		CC	+	
	Nails, Hairs	X Series (p.16)		X	+	
		- Hair Dimension (available only when selecting X series)		2D / 3D	+	
		- Hair Color (available only when selecting X series) BB (Brown-Black), BR (Brown), BL (Black)		BB/BR /BL	+	
		Acrylic Nails (p.17)		ACRN		
	Smooth Coating	Smooth Coating (p.19)		SC	+	
Options: Structural Changes	Wrist Connector (p.20)	- External threaded stud, Metric		EX-MT		
		- Internal, Metric		IN-MT		
		- External threaded stud, Imperial		EX-IP		
		- Internal, Imperial		IN-IP		
	Custom Filling (p.21)	- Foam		F		
		- Silicone		S		
		- Foam and Silicone (available depends on the length of the residual limb p.21)		F+S		
	Fingers Construction (p.23)	Wired Fingers	(with filling)	(available depends on the size of Silicone Prostheses & the length of residual limb p.23)	W	✓
		Hinged Fingers			HF	
		Reinforced Fingers * fingers with RF may be larger in circumference * not available when selecting SCM option			RF	✓
		Fingers Bend (available only when selecting SCM) B1 (Straight), B2 (Standard), B3 (Extra Bend)			B1/B2 /B3	
Zipper	Zipper (p.25) (plastic)		PZ			
	Glue To Socket (p.25) (prosthetic socket is required)		GTS			

How to order : See page 146

Please use the product codes from previous page.

Example:

100L - M - L - S - 3	-	D3P2 - X - SC	-
Basic specification		Options: Aesthetics and Surface Enhancement	Options: Structural Changes

How to measure : See page 147

Male, S(7") / Female, S(7")

Model 100L (pg:28)	Thickness: 2-3.5mm	(mm)
--------------------	--------------------	------

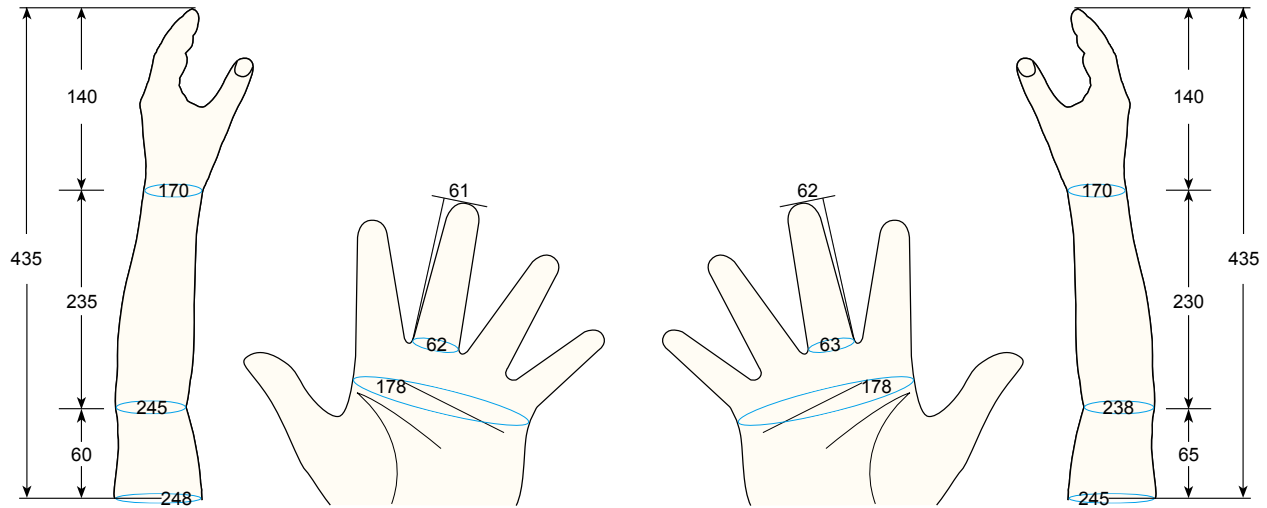

Model 100 (pg:29)	Thickness: 2-3.5mm	(mm)
-------------------	--------------------	------

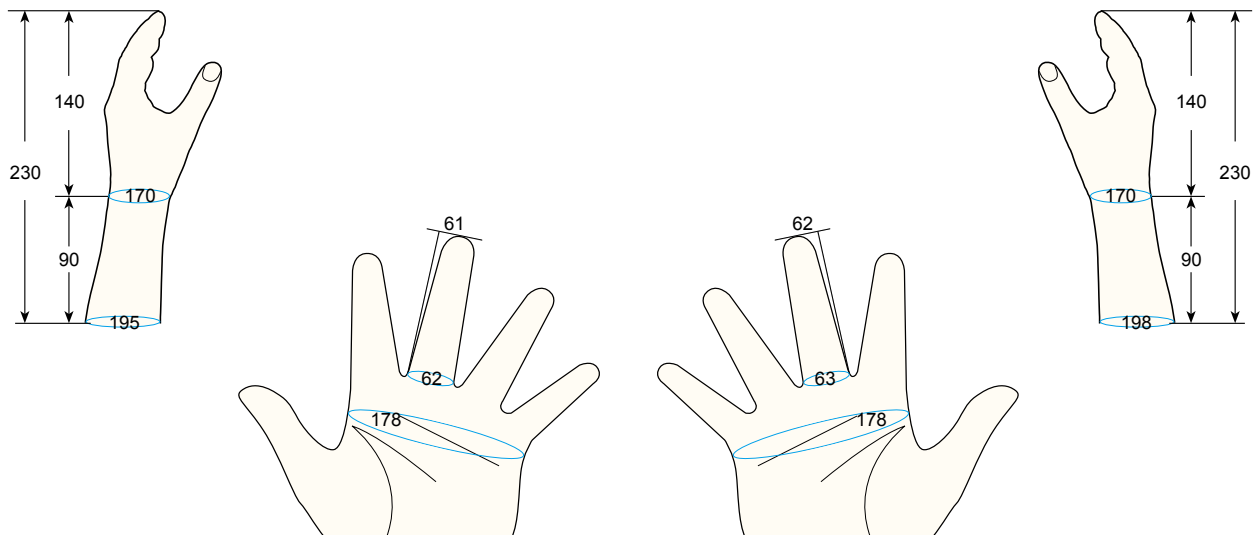

• All above information are for reference only •
• Please ask for more detail information •

Regal Silicone Prostheses

Product: Silicone pediatric myo glove

Model: 100PL

Size: PL (6 1/2"), PM (6")

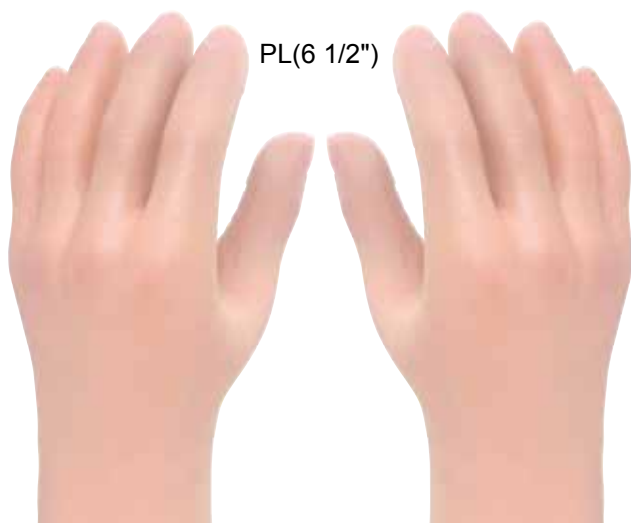

PL(6 1/2")



PM(6")

- ✓ = Standard feature
- O = Optional feature (no extra cost)
- + = Optional feature (extra cost)

Product Structure (List of all available features of each Model and Size)

Product features description			Models			
			PL	PM		
Basic Spec	Size	(Code: PL / PM)				
	Side	L / R	✓	✓		
	Color - Single (use color sample from Regal)		✓	✓		
Semi-Custom Made (p.7)		SCM				
Options: Aesthetics and Surface Enhancement	Color (p.14)	Dual Coloring Dorsal / Palmar (use color sample from Regal)	D/P	+	+	
		Custom Coloring (color sample is required)	CC	+	+	
	Nails, Hairs	X Series (p.16)		X	+	+
		- Hair Dimension (available only when selecting X series)	2D / 3D		+	+
		- Hair Color (available only when selecting X series)	BB/BR /BL		+	+
		BB (Brown-Black), BR (Brown), BL (Black)				
	Acrylic Nails (p.17)	ACRN				
Smooth Coating	Smooth Coating (p.19)	SC	+	+		
Options: Structural Changes	Wrist Connector (p.20)	- External threaded stud, Metric	EX-MT			
		- Internal, Metric	IN-MT			
		- External threaded stud, Imperial	EX-IP			
		- Internal, Imperial	IN-IP			
	Custom Filling (p.21)	- Foam	F			
		- Silicone	S			
		- Foam and Silicone	(available depends on the length of the residual limb p.21) F+S			
	Fingers Construction (p.23)	Wired Fingers	(with filling) (available depends on the size of Silicone Prostheses & the length of residual limb p.23)	W		
		Hinged Fingers		HF		
		Reinforced Fingers	* fingers with RF may be larger in circumference * not available when selecting SCM option	RF		
		Fingers Bend (available only when selecting SCM) B1 (Straight), B2 (Standard), B3 (Extra Bend)		B1/B2 /B3		
Zipper	Zipper (p.25) (plastic)	PZ				
	Glue To Socket (p.25) (prosthetic socket is required)	GTS				

How to order : See page 146

Please use the product codes from previous page.

Example:

100PL - L - PL - 3	-	D3P2 - X - SC	-
Basic specification		Options: Aesthetics and Surface Enhancement	Options: Structural Changes

How to measure : See page 147

PL (6 1/2")

Model 100PL (pg:30) Thickness: 2-2.5mm (mm)

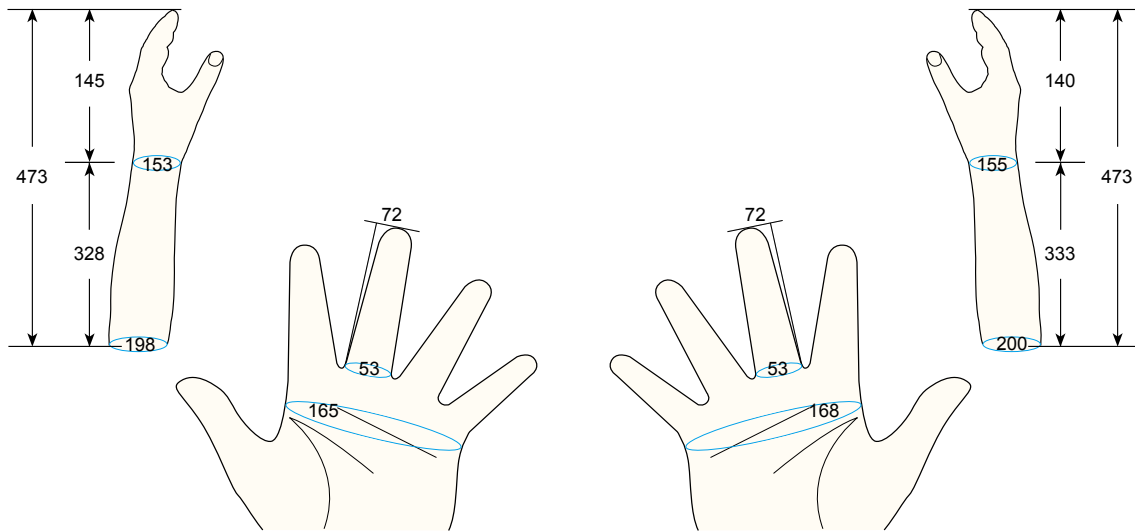

PM (6")

Model 100PL (pg:30) Thickness: 2-2.5mm (mm)

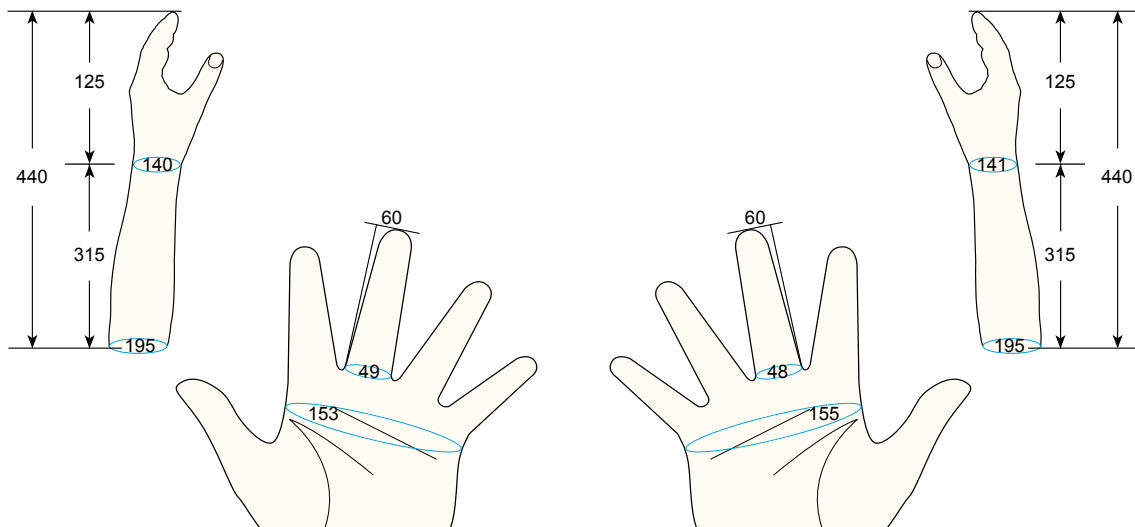

• All above information are for reference only •
• Please ask for more detail information •

Regal Silicone Prostheses

Product: Silicone pediatric myo glove

Model: 100PL

Size: PS (5 1/2"), PXS (5")

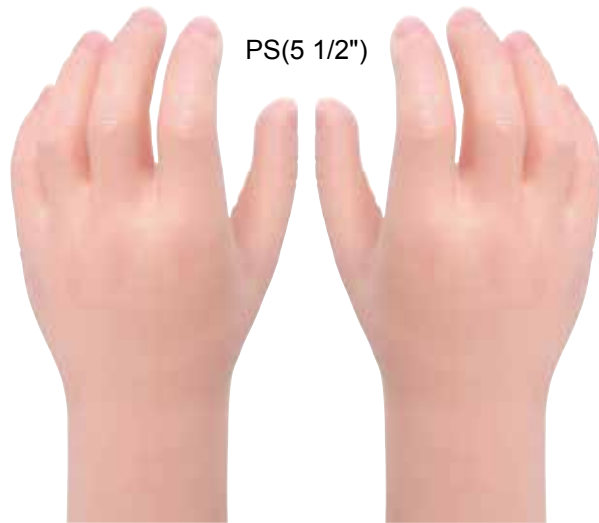

PS(5 1/2")

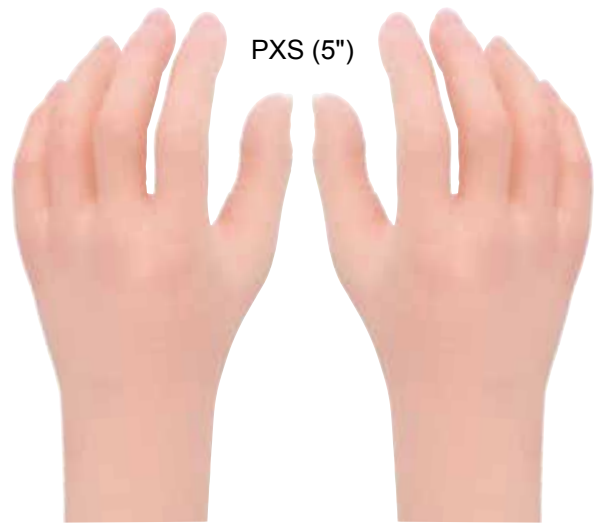

PXS (5")

- ✓ = Standard feature
- O = Optional feature (no extra cost)
- + = Optional feature (extra cost)

Product Structure (List of all available features of each Model and Size)

Product features description			Models		
			PS	PXS	
Basic Spec	Size	(Code: PS / PXS)			
	Side	L / R	✓	✓	
	Color - Single (use color sample from Regal)		✓	✓	
	Semi-Custom Made (p.7)		SCM		
Options: Aesthetics and Surface Enhancement	Color (p.14)	Dual Coloring Dorsal / Palmar (use color sample from Regal)	D/P	+	+
		Custom Coloring (color sample is required)	CC	+	+
		X Series (p.16)	X	+	+
	Nails, Hairs	- Hair Dimension (available only when selecting X series)	2D / 3D	+	+
		- Hair Color (available only when selecting X series) BB (Brown-Black), BR (Brown), BL (Black)	BB/BR /BL	+	+
		Acrylic Nails (p.17)	ACRN		
	Smooth Coating	Smooth Coating (p.19)	SC	+	+
Options: Structural Changes	Wrist Connector (p.20)	- External threaded stud, Metric	EX-MT		
		- Internal, Metric	IN-MT		
		- External threaded stud, Imperial	EX-IP		
		- Internal, Imperial	IN-IP		
	Custom Filling (p.21)	- Foam	F		
		- Silicone	S		
		- Foam and Silicone	(available depends on the length of the residual limb p.21) F+S		
	Fingers Construction (p.23)	Wired Fingers	(with filling) (available depends on the size of Silicone Prostheses & the length of residual limb p.23) W		
		Hinged Fingers	HF		
		Reinforced Fingers * fingers with RF may be larger in circumference * not available when selecting SCM option	RF		
	Fingers Bend (available only when selecting SCM) B1 (Straight), B2 (Standard), B3 (Extra Bend)	B1/B2 /B3			
Zipper	Zipper (p.25) (plastic)	PZ			
	Glue To Socket (p.25) (prosthetic socket is required)	GTS			

How to order : See page 146

Please use the product codes from previous page.

Example:

100PL - L - PS - 3	-	D3P2 - X - SC	-
Basic specification		Options: Aesthetics and Surface Enhancement	Options: Structural Changes

How to measure : See page 147

PS (5 1/2")

Model 100PL (pg:30) Thickness: 2-2.5mm (mm)

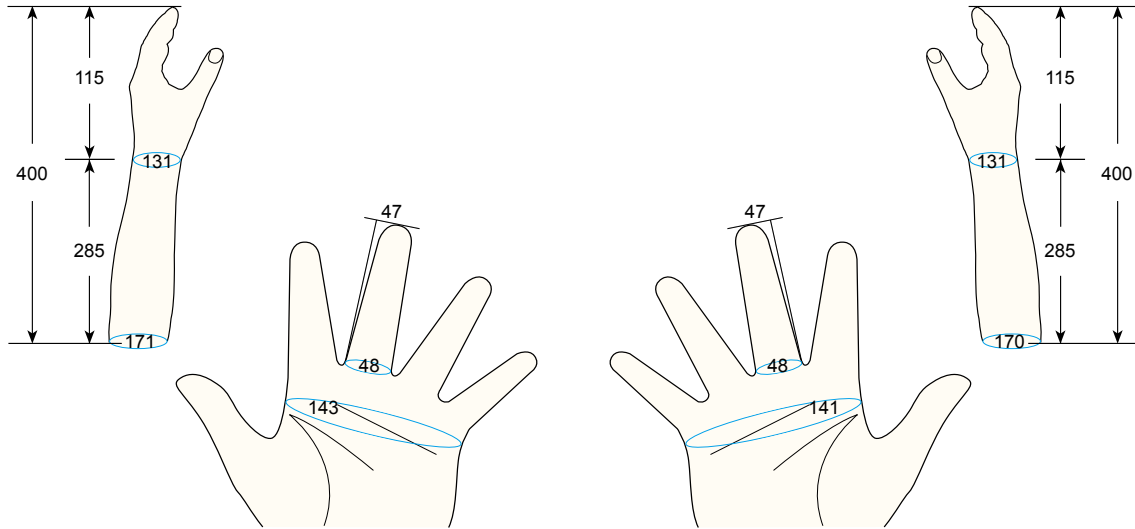

PXS (5")

Model 100PL (pg:30) Thickness: 2-2.5mm (mm)

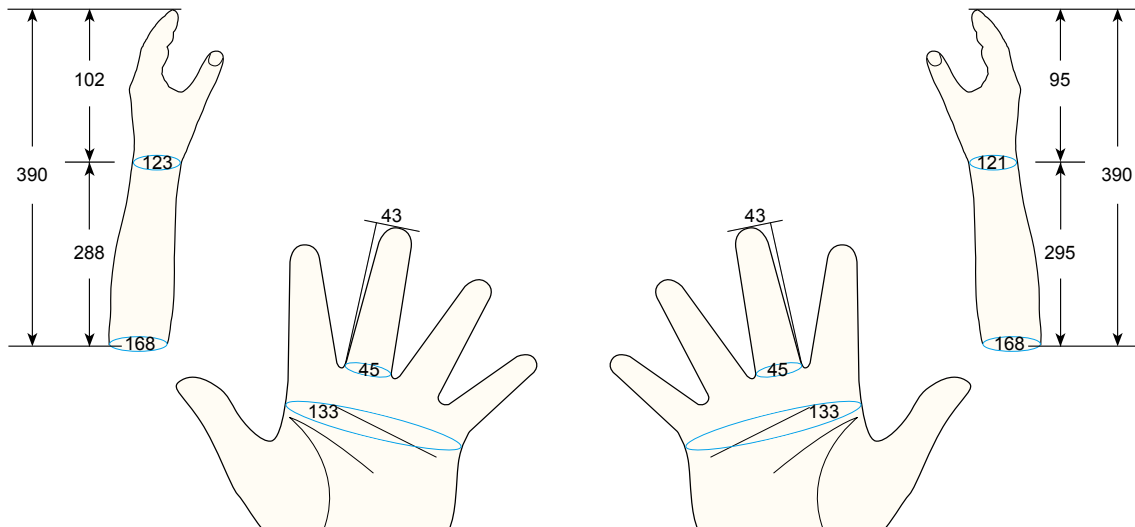

• All above information are for reference only •
• Please ask for more detail information •

Silicone Prosthetic glove

Model 101L, 102LS, 102L

Model 101LL, 102LSL, 102LL

Product descriptions:

- High definition silicone prosthetic gloves, fine handprints, veins and knuckles
- Design for wrist and above wrist amputation
- Model 101LL, 102LSL, 102LL: Long length models
- Model 101L, 102LS, 102L: Standard length models
- Upgrade options: See our Complete Product Structure page 26

Applications:

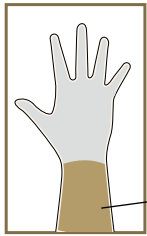

Model 101LL, 101L

- High definition silicone prosthetic gloves
- No Innerhand filling
- Upgrade options: See our Complete Product Structure page 26

Residual limb



Model 102LSL, 102LS

- Adjustable fingers
- Passive Innerhand foam filling
- Integrated wrist connector (M12x1.5 or 1/2"-20 and External or Internal threaded stud)
- Silicone filling is Standard feature for Male CS/CXS and Female CS/CXS
- Upgrade options: See our Complete Product Structure page 26

Wrist connector for connecting to the prosthetic arm socket



Model 102LL, 102L

- Adjustable fingers
- Passive Innerhand foam filling
- Silicone filling is Standard feature for Male CS/CXS and Female CS/CXS
- Upgrade options: See our Complete Product Structure page 26

Adhere to the prosthetic arm socket or wear direct



Size chart:

Adult																	
Size	XL	XL1	L	L1	L2	LM	LM1	M	M1	M2	M3	M4	MS	MS1	MS2	S	S1
Male	P.54	P.56	P.58	P.60	P.62	P.64	-	P.66	P.68	P.70	P.72	P.74	P.76	P.78	-	P.80	-
Female	P.64	-	P.82	P.70	P.84	P.76	P.78	P.86	-	-	-	-	P.80	-	P.90	P.88	P.92

Child							
Size	CL	CL1	CM	CM1	CS	CS1	CXS
Male	P.80	P.90	P.92	-	P.98	-	P.102
Female	P.92	-	P.94	P.96	P.98	P.100	P.102

Silicone Partial hand glove

Model 103

Product descriptions:

- High definition silicone prosthetic gloves, fine handprints, veins and knuckles
- Design for partial hand amputation
- Upgrade options: See our Complete Product Structure page 26



Applications:

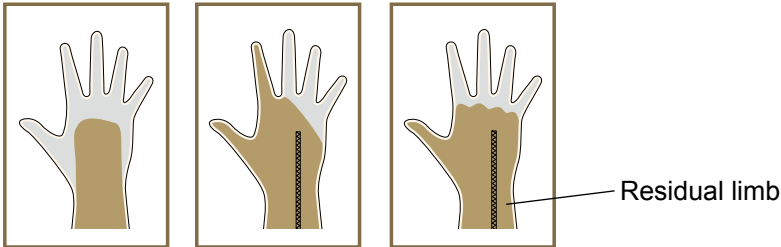

Size chart:

Adult																	
Size	XL	XL1	L	L1	L2	LM	LM1	M	M1	M2	M3	M4	MS	MS1	MS2	S	S1
Male	P.54	P.56	P.58	P.60	P.62	P.64	-	P.66	P.68	P.70	P.72	P.74	P.76	P.78	-	P.80	-
Female	P.64	-	P.82	P.70	P.84	P.76	P.78	P.86	-	-	-	-	P.80	-	P.90	P.88	P.92

Child							
Size	CL	CL1	CM	CM1	CS	CS1	CXS
Male	P.80	P.90	P.92	-	P.98	-	P.102
Female	P.92	-	P.94	P.96	P.98	P.100	P.102

Silicone Prosthetic finger

Model 200 series and Single finger

Product descriptions:

- High definition silicone fingers, fine fingerprints and knuckles
- Design for finger(s) amputation
- Upgrade options: See our Complete Product Structure page 26



Number of Finger amputated	Recommended Models	Description
Single finger	Model 201S, 202S, 203S, 204S, 205S	Thumb, Index, Middle, Ring, Little finger
Two connected fingers	Model 202-203C, 203-204C, 204-205C	Index-Middle, Middle-Ring, Ring-Little finger
Three connected fingers	Model 202-203-204C, 203-204-205C	Index-Middle-Ring, Middle-Ring-Little finger
Four connected fingers	Model 200C	If a separate thumb is needed, Model 200C-201S
Four separate fingers	Model 200S	If a separate thumb is needed, Model 200S-201S

Applications:

Examples:

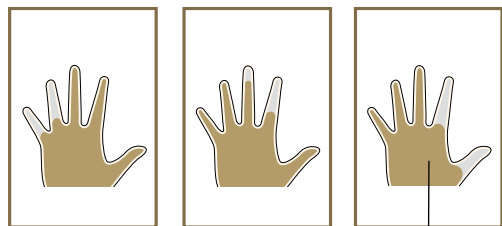

Residual limb



Single finger: 205S

Two connected fingers: 204-205C

Four connected fingers: 200C (cut out 203)

Four connected fingers: 200C (cut out 203, 204 205)

Customer may request to cut out the finger(s) to desired length

Size chart:

Adult																	
Size	XL	XL1	L	L1	L2	LM	LM1	M	M1	M2	M3	M4	MS	MS1	MS2	S	S1
Male	P.54	P.56	P.58	P.60	P.62	P.64	-	P.66	P.68	P.70	P.72	P.74	P.76	P.78	-	P.80	-
Female	P.64	-	P.82	P.70	P.84	P.76	P.78	P.86	-	-	-	-	P.80	-	P.90	P.88	P.92

Child							
Size	CL	CL1	CM	CM1	CS	CS1	CXS
Male	P.80	P.90	P.92	-	P.98	-	P.102
Female	P.92	-	P.94	P.96	P.98	P.100	P.102

Silicone Child crawling hand

Model CH

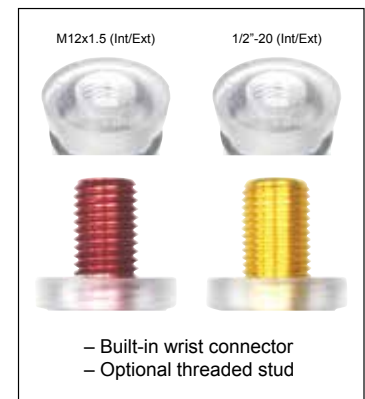

Product description and applications:

- Silicone crawling hands allow children to begin bi-manular activities
- Closed fist, no fingers to poke siblings or playmate
- Silicone filled allows long lasting against wear and tear
- Built-in wrist connector with a choice of: M12x1.5 or 1/2"-20 and External or Internal threaded stud
- Sizes: L, M and S
- Upgrade options: See our Complete Product Structure page 26

Size measurement chart

Left & Right	C1 (mm)	C2 (mm)	C3 (mm)	L1 (mm)	L2 (mm)	L3 (mm)
Large	155	109	130	78	65	143
Medium	143	103	122	72	60	132
Small	132	93	113	66	55	121

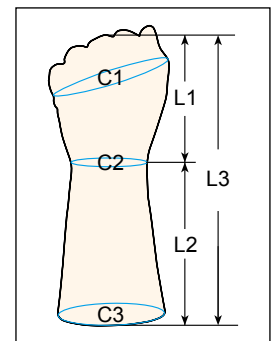

How to order

Model no.	Size	Left / Right	Thread stud (EX=External, IN=Internal)	Thread type (MT=M12x1.5; IP=1/2"-20)	Color
CH	L	L/R	EX / IN	MT / IP	See Regal color sample
CH	M	L/R	EX / IN	MT / IP	
CH	S	L/R	EX / IN	MT / IP	

Regal silicone prosthetic gloves - Size measurement chart

For Model 101L, 102LS, 102L, 101LL, 102LSL, 102LL (wrist or above wrist amputation)

Male - gloves thickness: 2-2.5mm										Female - gloves thickness: 2-2.5mm											
OttoBock gloves	Regal gloves	(mm)						Standard length	Long length	Catalogue 2015 page	OttoBock gloves	Regal gloves	(mm)						Standard length	Long length	Catalogue 2015 page
		C1	C3	C11	L5	E	F						C1	C3	C11	L5	E	F			
8S4=238x92L	XL Left	235	196	80	74	310	544	P.54	Adult	8S5=208x89L	XL Left	220	183	79	76	314	535	P.64			
8S4=244x94R	XL Right	239	210	84	76	310	538	P.54		8S5=210x89R	XL Right	223	183	76	80	323	536	P.64			
8S4=228x88L 8S4=228x84L 8S4=221x81L	XL1 Left	233	196	82	73	395	538	P.56		-	L Left	205	179	72	67	297	487	P.82			
8S4=228x89R 8S4=225x82R 8S4=222x84R	XL1 Right	230	194	77	77	373	530	P.56		-	L Right	206	179	71	65	290	487	P.82			
8S4=232x94L	L Left	230	190	74	78	320	533	P.58		8S5=195x78L	L1 Left	202	170	66	74	315	532	P.70			
8S4=230x93R	L Right	231	196	75	77	318	530	P.58		8S5=195x78R	L1 Right	203	174	64	71	319	532	P.70			
-	L1 Left	220	193	76	67	335	556	P.60		8S5=195x79L	L2 Left	202	174	72	70	313	470	P.84			
-	L1 Right	233	200	81	66	336	550	P.60		8S5=200x79R	L2 Right	203	174	72	67	310	460	P.84			
-	L2 Left	228	187	73	76	370	545	P.62													
-	L2 Right	229	197	77	76	373	546	P.62													
8S4=220x91L 8S4=218x85L 8S4=214x82L 8S4=213x85L 8S4=212x93L	LM Left	220	183	79	76	314	535	P.64		8S5=194x82L 8S5=192x78L	LM Left	189	163	62	67	288	481	P.76			
8S4=218x85R 8S4=218x83R 8S4=215x83R 8S4=214x90R 8S4=215x93R	LM Right	223	183	76	80	323	536	P.64		8S5=191x78R 8S5=189x84R	LM Right	198	166	64	70	295	488	P.76			
8S4=211x88L 8S4=208x85L 8S4=207x86L 8S4=206x87L	M Left	209	185	72	70	327	542	P.66		-	LM1 Left	190	162	63	70	290	501	P.78			
8S4=212x86R 8S4=212x83R 8S4=215x88R 8S4=209x86R	M Right	212	188	72	72	320	532	P.66		-	LM1 Right	198	162	65	71	303	497	P.78			
8S4=206x80L 8S4=205x81L	M1 Left	208	184	70	67	317	528	P.68		8S5=182x84L 8S5=180x80L	M Left	182	156	66	69	293	452	P.86			
8S4=205x81R 8S4=205x80R	M1 Right	212	184	73	68	320	518	P.68		8S5=190x84R 8S5=176x80R	M Right	184	155	66	68	293	450	P.86			
8S4=203x85L 8S4=203x83L	M2 Left	202	170	66	74	315	532	P.70		8S5=190x93L 8S5=190x77L 8S5=188x79L	MS Left	188	162	62	69	307	463	P.80			
8S4=206x85R 8S4=199x82R	M2 Right	203	174	64	71	319	532	P.70		8S5=190x93R 8S5=190x77R 8S5=188x79R	MS Right	190	160	64	70	317	463	P.80			
8S4=202x74L	M3 Left	213	176	67	73	330	528	P.72		-	MS2 Left	181	157	61	65	335	526	P.90			
8S4=206x76R	M3 Right	204	175	70	67	345	538	P.72		-	MS2 Right	185	157	63	64	330	522	P.90			
-	M4 Left	210	177	71	69	344	512	P.74		8S5=185x75L 8S5=184x78L 8S5=184x75L	S Left	180	160	62	60	286	479	P.88			
-	M4 Right	202	167	67	67	340	530	P.74		8S5=187x74R 8S5=184x78R 8S5=181x75R	S Right	188	162	62	62	292	468	P.88			
-	MS Left	189	163	62	67	288	481	P.76		8S5=174x74L 8S5=165x72L	S1 Left	178	144	54	65	299	481	P.92			
-	MS Right	198	166	64	70	295	488	P.76		8S5=175x76R 8S5=167x72R	S1 Right	175	147	54	65	298	477	P.92			
-	MS1 Left	190	162	63	70	290	501	P.78													
-	MS1 Right	198	162	65	71	303	497	P.78													
-	S Left	188	162	62	69	307	463	P.80													
-	S Right	190	160	64	70	317	463	P.80													
-	CL Left	188	162	62	69	307	463	P.80		8S6=170x65L	CL Left	178	144	54	65	299	481	P.92			
-	CL Right	190	160	64	70	317	463	P.80		8S6=170x65R	CL Right	175	147	54	65	298	477	P.92			
-	CL1 Left	181	157	61	65	335	526	P.90													
-	CL1 Right	185	157	63	64	330	522	P.90													
8S6=170x65L 8S6=168x70L 8S6=165x68L	CM Left	178	144	54	65	299	481	P.92	8S6=168x70L 8S6=165x68L	CM Left	173	142	57	62	310	473	P.94				
8S6=170x65R 8S6=166x70R 8S6=158x68R	CM Right	175	147	54	65	298	477	P.92	8S6=166x70R 8S6=158x68R	CM Right	165	138	55	64	295	473	P.94				
8S6=142x50L 8S6=138x58L	CS Left	141	119	51	48	255	443	P.98													
8S6=139x51R 8S6=138x58R	CS Right	140	123	50	49	245	437	P.98	8S6=142x50L 8S6=138x58L	CS Left	141	119	51	48	255	443	P.98				
									8S6=139x51R 8S6=138x58R	CS Right	140	123	50	49	245	437	P.98				
-	CXS Left	125	115	43	45	214	391	P.102													
-	CXS Right	131	120	43	44	223	383	P.102													

The above information is for reference only. Please contact our technicians if you are not sure which size to choose.

Regal silicone prosthetic gloves - Size measurement chart

Measure Palm Circumference **C1** of the sound hand then choose a few closest Sizes from Regal Size Measurement Chart. From the Sizes chosen, select the appearance that closely resemble to the sound hand.

Note: some sizes are unisex.

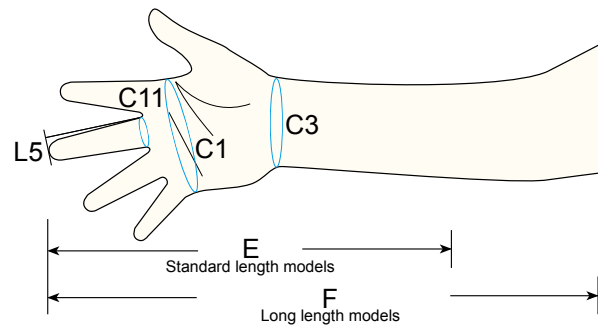

How to measure : See page 147

For Model 103 (partial hand amputation)

Male - gloves thickness: 2-2.5mm								Female - gloves thickness: 2-2.5mm								
Regal gloves		(mm)					Catalogue 2015 page		Regal gloves		(mm)					Catalogue 2015 page
		C1	C3	C11	L5	E					C1	C3	C11	L5	E	
XL	Left	238	201	80	73	208	P.54	Adult	XL	Left	216	189	79	76	215	P.64
XL	Right	243	210	84	77	213	P.54		XL	Right	230	199	80	74	201	P.64
XL1	Left	233	204	85	73	238	P.56		L	Left	204	178	70	67	208	P.82
XL1	Right	230	195	78	77	235	P.56		L	Right	208	180	71	67	198	P.82
L	Left	234	205	75	76	219	P.58		L1	Left	199	167	65	73	203	P.70
L	Right	240	207	80	75	208	P.58		L1	Right	203	168	65	71	203	P.70
L1	Left	214	192	72	66	211	P.60		L2	Left	204	180	73	70	213	P.84
L1	Right	226	193	78	65	208	P.60		L2	Right	203	179	71	67	203	P.84
L2	Left	228	185	71	76	240	P.62		LM	Left	189	167	63	66	200	P.76
L2	Right	229	196	75	77	240	P.62		LM	Right	198	163	64	69	196	P.76
LM	Left	216	189	79	76	215	P.64		LM1	Left	190	165	61	69	195	P.78
LM	Right	230	199	80	74	201	P.64		LM1	Right	200	161	64	70	198	P.78
M	Left	210	185	72	68	213	P.66		M	Left	189	174	68	69	203	P.86
M	Right	215	188	71	69	200	P.66		M	Right	185	167	66	68	198	P.86
M1	Left	207	185	69	67	198	P.68		MS	Left	190	169	64	70	193	P.80
M1	Right	213	180	72	67	198	P.68		MS	Right	193	167	64	70	195	P.80
M2	Left	199	167	65	73	203	P.70		MS2	Left	183	163	61	65	206	P.90
M2	Right	203	168	65	71	203	P.70		MS2	Right	185	164	64	64	206	P.90
M3	Left	216	173	67	72	213	P.72		S	Left	180	159	60	60	197	P.88
M3	Right	204	166	69	67	223	P.72		S	Right	186	165	62	62	195	P.88
M4	Left	210	179	71	70	210	P.74		S1	Left	175	145	55	65	179	P.92
M4	Right	207	173	68	67	203	P.74		S1	Right	175	150	55	67	185	P.92
MS	Left	189	167	63	66	200	P.76									
MS	Right	198	163	64	69	196	P.76									
MS1	Left	190	165	61	69	195	P.78									
MS1	Right	200	161	64	70	198	P.78									
S	Left	190	169	64	70	193	P.80									
S	Right	193	167	64	70	195	P.80									
CL	Left	190	169	64	70	193	P.80									
CL	Right	193	167	64	70	195	P.80									
CL1	Left	183	163	61	65	206	P.90									
CL1	Right	185	164	64	64	206	P.90									
CM	Left	175	145	55	65	179	P.92									
CM	Right	175	150	55	67	185	P.92									
								CM	Left	173	150	56	63	175	P.94	
								CM	Right	166	139	55	64	180	P.94	
								CM1	Left	??	??	??	??	??	P.96	
								CM1	Right	??	??	??	??	??	P.96	
								CS	Left	140	119	51	48	165	P.98	
								CS	Right	143	123	51	49	155	P.98	
								CS1	Left	??	??	??	??	??	P.100	
								CS1	Right	??	??	??	??	??	P.100	
								CXS	Left	125	115	43	45	165	P.102	
								CXS	Right	130	119	45	43	158	P.102	

The above information is for reference only. Please contact our technicians if you are not sure which size to choose.

Regal Silicone Prostheses

Upgrade Option

Myo-Electric & Mechanical Gloves

Gloves, Passive & Partial Hands, Digits

Footcovers

Leg / Arm Sleeve Maxillofacial / Accessories

FAQ & Warranty

Product: Silicone prosthetic glove

Model: 101L, 102L, 102LS, 101LL, 102LL, 102LSL, 103, 200, Single finger

Size: Male, XL



- ✓ = Standard feature
- O = Optional feature (no extra cost)
- + = Optional feature (extra cost)

Product Structure (List of all available features of each Model and Size)

Product features description			Code	Models					
				101L, 101LL	102L, 102LL	102LS, 102LSL	103	200 & Finger	
Basic Spec	Gender, Size		M-XL	✓	✓	✓	✓	✓	
	Side		L / R	✓	✓	✓	✓	✓	
	Color - Single (use color sample from Regal)			✓	✓	✓	✓	✓	
Semi-Custom Made (p.7)			SCM	+	+	+	+	+	
Options: Aesthetics and Surface Enhancement	Color (p.14)	Dual Coloring Dorsal / Palmar (use color sample from Regal)		D/P	+	+	+	+	
		Custom Coloring (color sample is required)		CC	+	+	+	+	
	Nails, Hairs	X Series (p.16)		X	+	+	+	+	
		- Hair Dimension (available only when selecting X series)		2D / 3D	+	+	+	+	
		- Hair Color (available only when selecting X series) BB (Brown-Black), BR (Brown), BL (Black)		BB/BR /BL	+	+	+	+	
		Acrylic Nails (p.17)		ACRN					
	Smooth Coating	Smooth Coating (p.19)		SC	+	+	+	+	
Options: Structural Changes	Wrist Connector (p.20)	- External threaded stud, Metric		EX-MT			✓		
		- Internal, Metric		IN-MT			O		
		- External threaded stud, Imperial		EX-IP				O	
		- Internal, Imperial		IN-IP				O	
	Custom Filling (p.21)	- Foam		F		+		+	
		- Silicone		S		+		+	
		- Foam and Silicone (available depends on the length of the residual limb p.21)		F+S		+		+	
	Fingers Construction (p.23)	Wired Fingers	(with filling)	(available depends on the size of Silicone Prostheses & the length of residual limb p.23)	W		✓	✓	
		Hinged Fingers			HF		+	+	+
		Reinforced Fingers * fingers with RF may be larger in circumference * not available when selecting SCM option			RF	+	+	+	
Fingers Bend (available only when selecting SCM) B1 (Straight), B2 (Standard), B3 (Extra Bend)			B1/B2 /B3				+		
Zipper	Zipper (p.25) (plastic)		PZ	+	+	+	✓		
	Glue To Socket (p.25) (prosthetic socket is required)		GTS		+	+			

How to order : See page 146

Please use the product codes from previous page.

Example:

102LSL - M - L - XL	-	D3P2 - X - 2D - SC	-	HF - RF
Basic specification		Options: Aesthetics and Surface Enhancement		Options: Structural Changes

How to measure : See page 147

Male, XL

Model 200 series and Single finger (pg:50) Thickness: 1-1.8mm (mm)

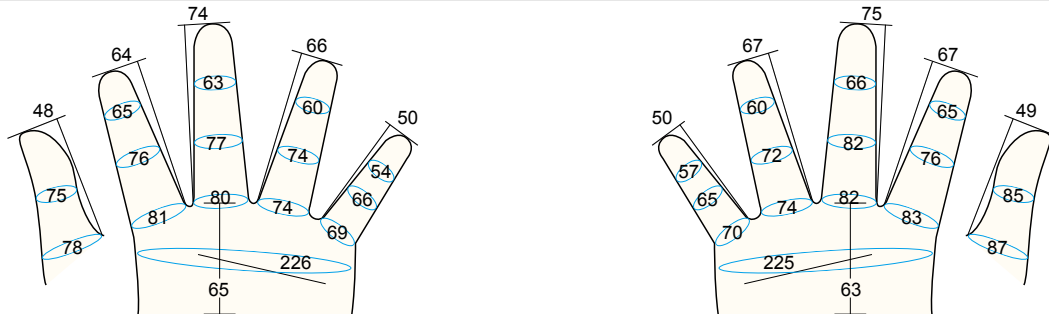

Model 103 (pg:49) Thickness: 2-2.5mm (mm)

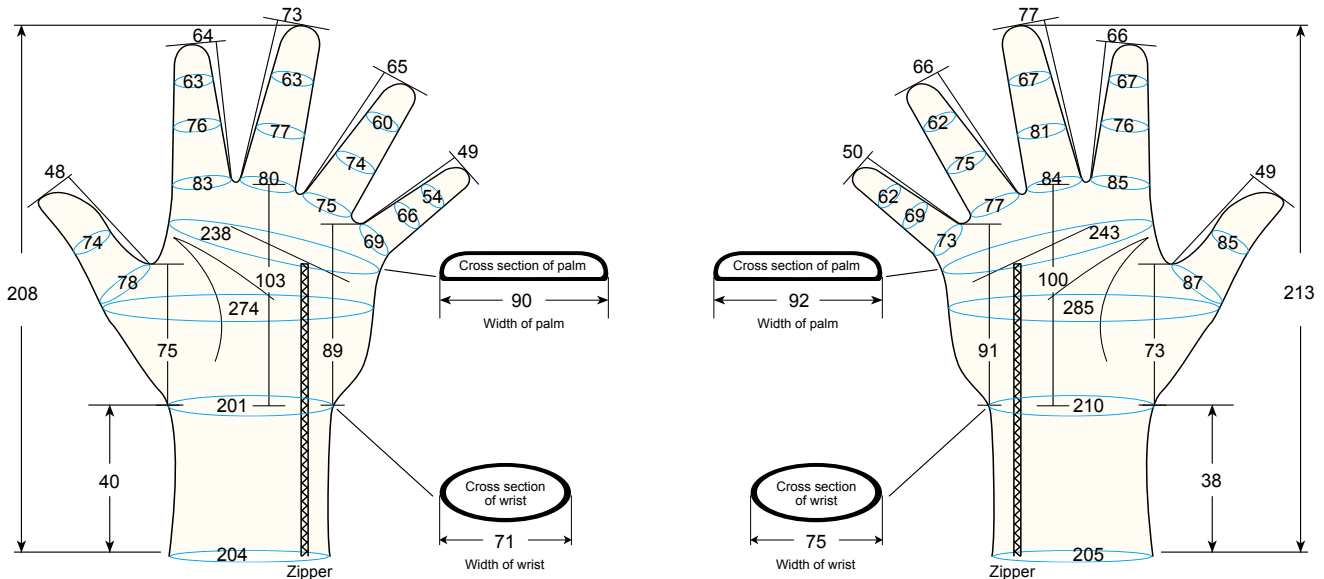

Model 101L, 102LS, 102L, 101LL, 102LSL, 102LL (pg:48) Thickness: 2-2.5mm (mm)

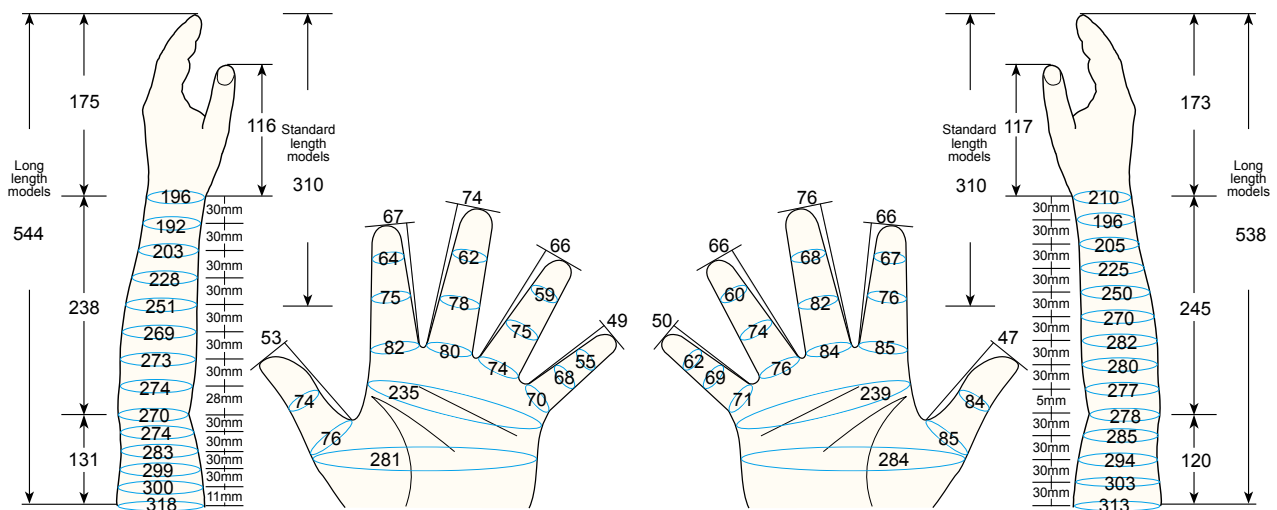

• All above information are for reference only •
• Please ask for more detail information •

Regal Silicone Prostheses

Upgrade Option

Myo-Electric & Mechanical Gloves

Gloves, Passive & Partial Hands, Digits

Footcovers

Leg / Arm Sleeve Maxillofacial / Accessories

FAQ & Warranty

Product: Silicone prosthetic glove

Model: 101L, 102L, 102LS, 101LL, 102LL, 102LSL, 103, 200, Single finger

Size: Male, XL1



- ✓ = Standard feature
- O = Optional feature (no extra cost)
- + = Optional feature (extra cost)

Product Structure (List of all available features of each Model and Size)

Product features description				Models					
Code				101L, 101LL	102L, 102LL	102LS, 102LSL	103	200 & Finger	
Basic Spec	Gender, Size			M-XL1	✓	✓	✓	✓	✓
	Side			L / R	✓	✓	✓	✓	✓
	Color - Single (use color sample from Regal)				✓	✓	✓	✓	✓
Semi-Custom Made (p.7)				SCM	+	+	+	+	+
Options: Aesthetics and Surface Enhancement	Color (p.14)	Dual Coloring Dorsal / Palmar (use color sample from Regal)		D/P	+	+	+	+	+
		Custom Coloring (color sample is required)		CC	+	+	+	+	+
	Nails, Hairs	X Series (p.16)		X	+	+	+	+	+
		- Hair Dimension (available only when selecting X series)		2D / 3D	+	+	+	+	+
		- Hair Color (available only when selecting X series) BB (Brown-Black), BR (Brown), BL (Black)		BB/BR /BL	+	+	+	+	+
		Acrylic Nails (p.17)		ACRN					
	Smooth Coating	Smooth Coating (p.19)		SC	+	+	+	+	+
Options: Structural Changes	Wrist Connector (p.20)	- External threaded stud, Metric		EX-MT			✓		
		- Internal, Metric		IN-MT			O		
		- External threaded stud, Imperial		EX-IP				O	
		- Internal, Imperial		IN-IP				O	
	Custom Filling (p.21)	- Foam		F		+		+	+
		- Silicone		S		+		+	+
		- Foam and Silicone		(available depends on the length of the residual limb p.21) F+S		+		+	+
	Fingers Construction (p.23)	Wired Fingers	(with filling)	(available depends on the size of Silicone Prostheses & the length of residual limb p.23)	W		✓	✓	
		Hinged Fingers			HF		+	+	+
		Reinforced Fingers * fingers with RF may be larger in circumference * not available when selecting SCM option			RF	+	+	+	
		Fingers Bend (available only when selecting SCM) B1 (Straight), B2 (Standard), B3 (Extra Bend)			B1/B2 /B3				
Zipper	Zipper (p.25) (plastic)		PZ	+	+	+	✓		
	Glue To Socket (p.25) (prosthetic socket is required)		GTS		+	+			

How to order : See page 146

Please use the product codes from previous page.

Example:

102LSL - M - L - XL1	-	D3P2 - X - 2D - SC	-	HF - RF
Basic specification		Options: Aesthetics and Surface Enhancement	Options: Structural Changes	

How to measure : See page 147

Male, XL1

Model 200 series and Single finger (pg:50)

Thickness: 1-1.8mm

(mm)

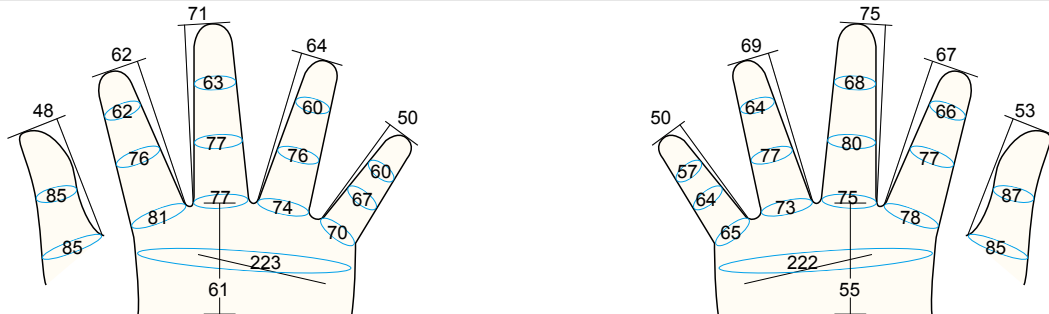

Model 103 (pg:49)

Thickness: 2-2.5mm

(mm)

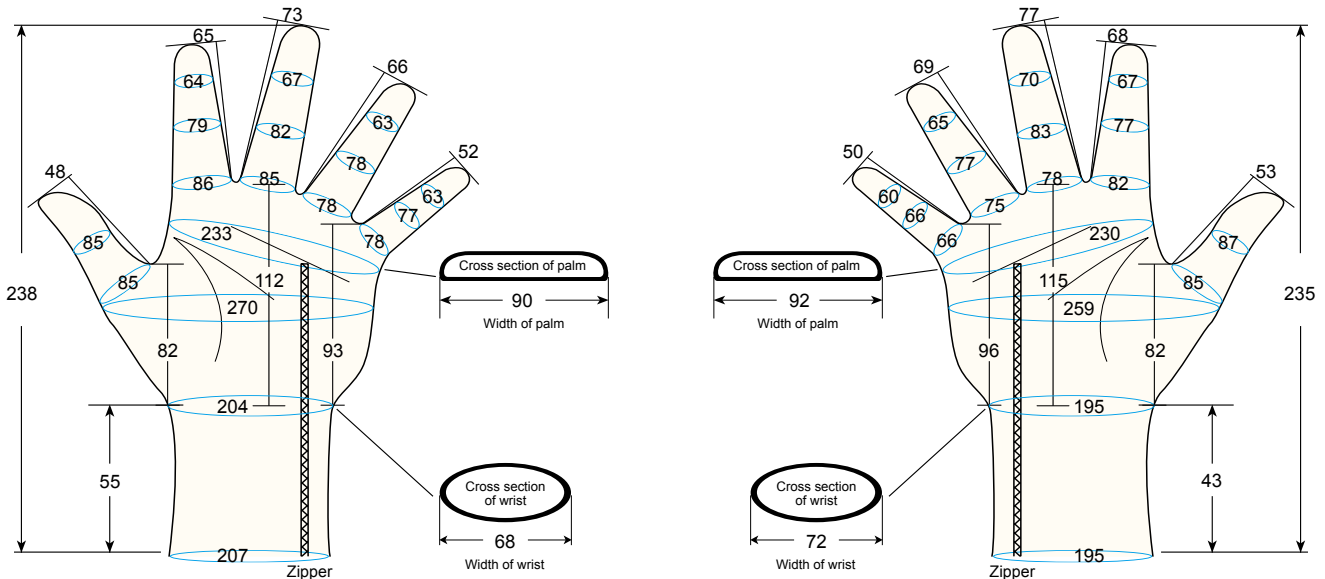

Model 101L, 102LS, 102L, 101LL, 102LSL, 102LL (pg:48)

Thickness: 2-2.5mm

(mm)

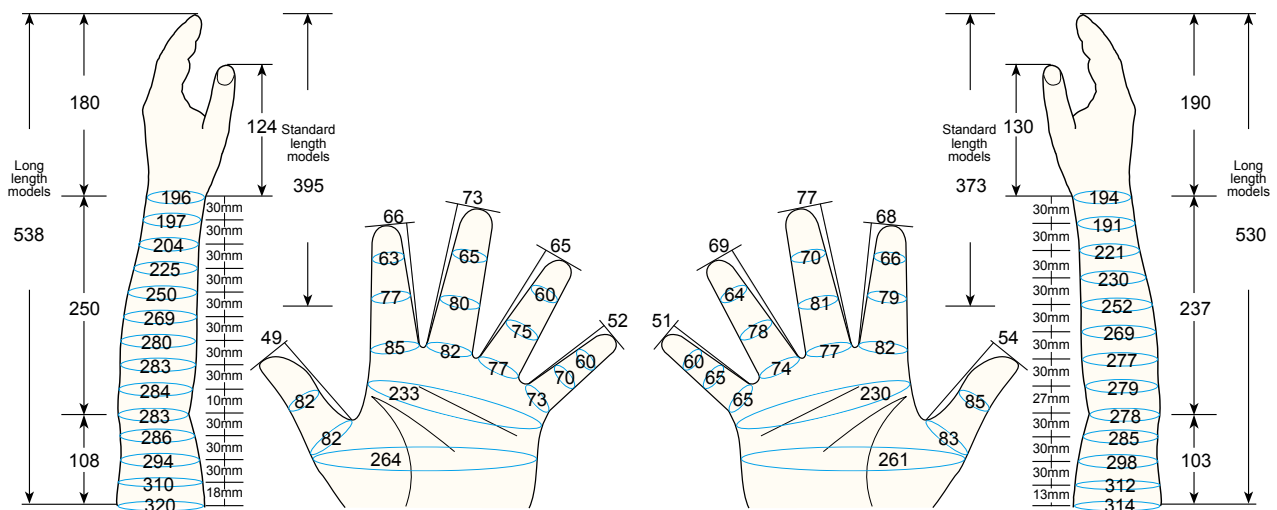

• All above information are for reference only •
• Please ask for more detail information •

Regal Silicone Prostheses

Product: Silicone prosthetic glove

Model: 101L, 102L, 102LS,
101LL, 102LL, 102LSL
103
200, Single finger

Size: Male, L



✓ = Standard feature
O = Optional feature (no extra cost)
+ = Optional feature (extra cost)

Upgrade Option

Myo-Electric & Mechanical Gloves

Gloves, Passive & Partial Hands, Digits

Footcovers

Leg / Arm Sleeve Maxillofacial / Accessories

FAQ & Warranty

Product Structure (List of all available features of each Model and Size)

Product features description				Models				
Code				101L, 101LL	102L, 102LL	102LS, 102LSL	103	200 & Finger
Basic Spec	Gender, Size			M-L	✓	✓	✓	✓
	Side			L / R	✓	✓	✓	✓
	Color - Single (use color sample from Regal)				✓	✓	✓	✓
Semi-Custom Made (p.7)				SCM	+	+	+	+
Options: Aesthetics and Surface Enhancement	Color (p.14)	Dual Coloring Dorsal / Palmar (use color sample from Regal)		D/P	+	+	+	+
		Custom Coloring (color sample is required)		CC	+	+	+	+
	Nails, Hairs	X Series (p.16)		X	+	+	+	+
		- Hair Dimension (available only when selecting X series)		2D / 3D	+	+	+	+
		- Hair Color (available only when selecting X series) BB (Brown-Black), BR (Brown), BL (Black)		BB/BR /BL	+	+	+	+
		Acrylic Nails (p.17)		ACRN				
	Smooth Coating	Smooth Coating (p.19)		SC	+	+	+	+
Options: Structural Changes	Wrist Connector (p.20)	- External threaded stud, Metric		EX-MT			✓	
		- Internal, Metric		IN-MT			O	
		- External threaded stud, Imperial		EX-IP			O	
		- Internal, Imperial		IN-IP			O	
	Custom Filling (p.21)	- Foam		F		+		+
		- Silicone		S		+		+
		- Foam and Silicone		(available depends on the length of the residual limb p.21) F+S		+		+
	Fingers Construction (p.23)	Wired Fingers	(with filling)	(available depends on the size of Silicone Prostheses & the length of residual limb p.23) W		✓	✓	
		Hinged Fingers		HF		+	+	+
		Reinforced Fingers * fingers with RF may be larger in circumference * not available when selecting SCM option		RF	+	+	+	
Fingers Bend (available only when selecting SCM) B1 (Straight), B2 (Standard), B3 (Extra Bend)		B1/B2 /B3					+	
Zipper	Zipper (p.25) (plastic)		PZ	+	+	+	✓	
Glue To Socket (p.25) (prosthetic socket is required)				GTS		+	+	

How to order : See page 146

Please use the product codes from previous page.

Example:

102LSL - M - L - L	-	D3P2 - X - 2D - SC	-	HF - RF
Basic specification		Options: Aesthetics and Surface Enhancement		Options: Structural Changes

How to measure : See page 147

Male, L

Model 200 series and Single finger (pg:50)

Thickness: 1-1.8mm

(mm)

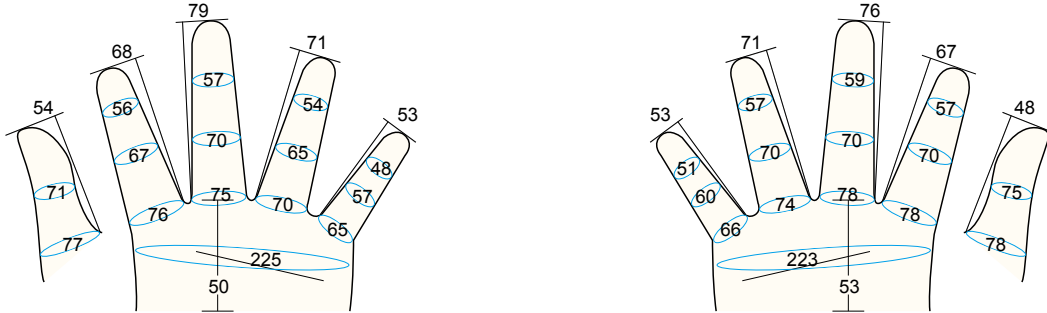

Model 103 (pg:49)

Thickness: 2-2.5mm

(mm)

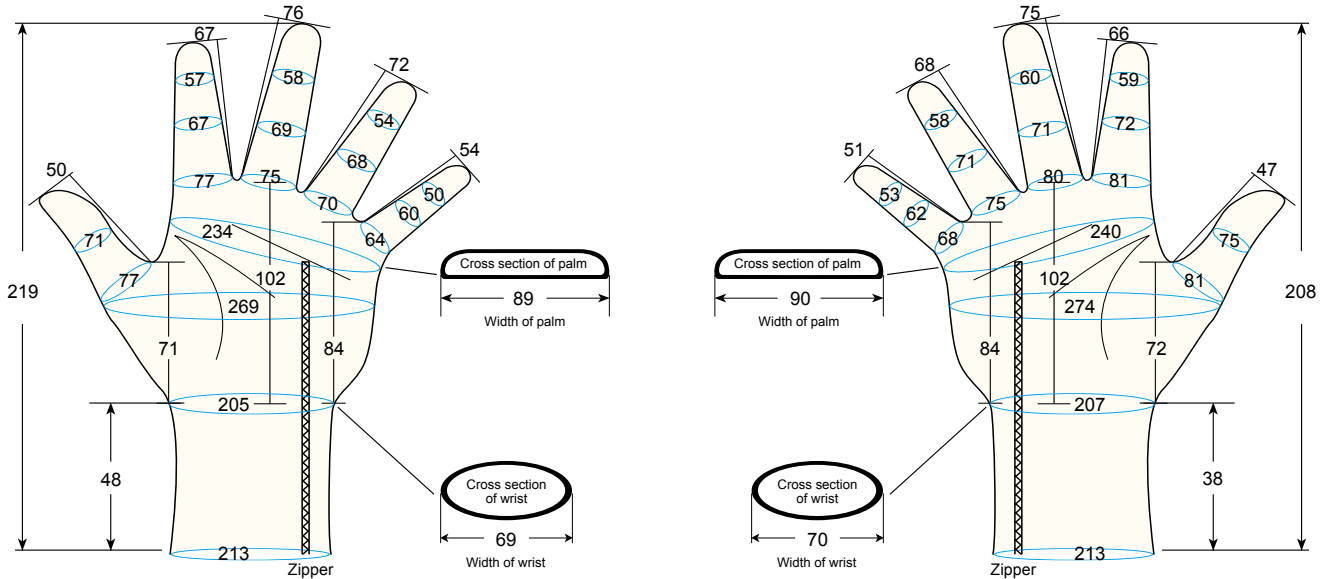

Model 101L, 102LS, 102L, 101LL, 102LSL, 102LL (pg:48)

Thickness: 2-2.5mm

(mm)

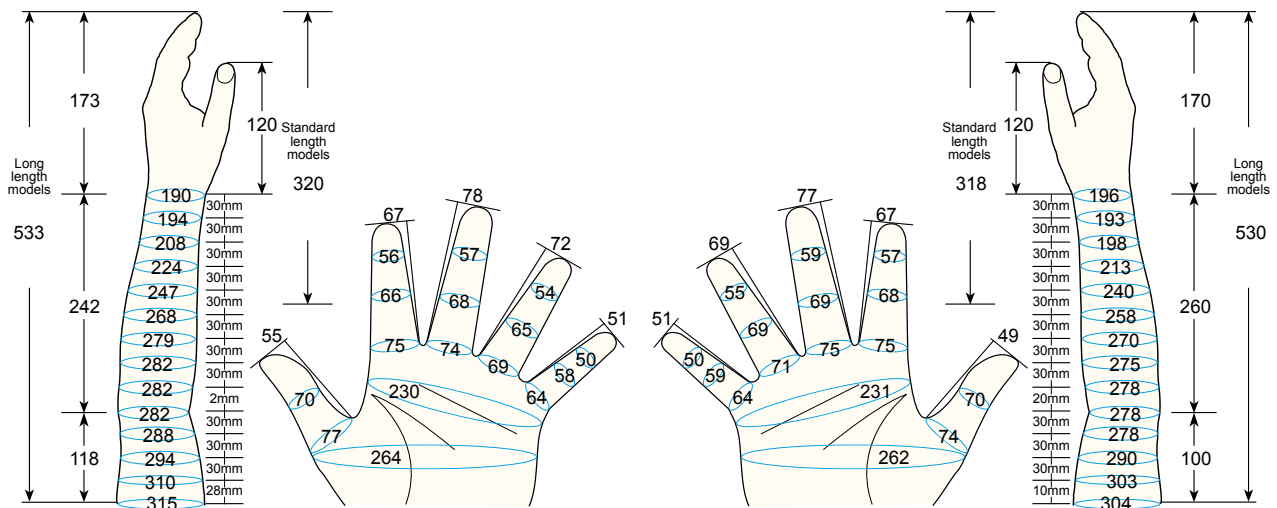

• All above information are for reference only •
• Please ask for more detail information •

Regal Silicone Prostheses

Product: Silicone prosthetic glove

Model: 101L, 102L, 102LS,
101LL, 102LL, 102LSL
103
200, Single finger

Size: Male, L1



✓ = Standard feature
O = Optional feature (no extra cost)
+ = Optional feature (extra cost)

Product Structure (List of all available features of each Model and Size)

Product features description				Models					
Code				101L, 101LL	102L, 102LL	102LS, 102LSL	103	200 & Finger	
Basic Spec	Gender, Size		M-L1	✓	✓	✓	✓	✓	
	Side		L / R	✓	✓	✓	✓	✓	
	Color - Single (use color sample from Regal)			✓	✓	✓	✓	✓	
Semi-Custom Made (p.7)			SCM	+	+	+	+	+	
Options: Aesthetics and Surface Enhancement	Color (p.14)	Dual Coloring Dorsal / Palmar (use color sample from Regal)		D/P	+	+	+	+	
		Custom Coloring (color sample is required)		CC	+	+	+	+	
	Nails, Hairs	X Series (p.16)		X	+	+	+	+	
		- Hair Dimension (available only when selecting X series)		2D / 3D	+	+	+	+	+
		- Hair Color (available only when selecting X series) BB (Brown-Black), BR (Brown), BL (Black)		BB/BR /BL	+	+	+	+	+
		Acrylic Nails (p.17)		ACRN					
	Smooth Coating	Smooth Coating (p.19)		SC	+	+	+	+	
Options: Structural Changes	Wrist Connector (p.20)	- External threaded stud, Metric		EX-MT			✓		
		- Internal, Metric		IN-MT			O		
		- External threaded stud, Imperial		EX-IP				O	
		- Internal, Imperial		IN-IP				O	
	Custom Filling (p.21)	- Foam		F		+		+	
		- Silicone		S		+		+	
		- Foam and Silicone		F+S		+		+	
	Fingers Construction (p.23)	Wired Fingers	(with filling)	(available depends on the length of the residual limb p.21)	W		✓	✓	
		Hinged Fingers		(available depends on the size of Silicone Prostheses & the length of residual limb p.23)	HF		+	+	+
		Reinforced Fingers * fingers with RF may be larger in circumference * not available when selecting SCM option			RF	+	+	+	
Fingers Bend (available only when selecting SCM) B1 (Straight), B2 (Standard), B3 (Extra Bend)			B1/B2 /B3				+		
Zipper	Zipper (p.25) (plastic)		PZ	+	+	+	✓		
	Glue To Socket (p.25) (prosthetic socket is required)		GTS		+	+			

How to order : See page 146

Please use the product codes from previous page.

Example:

102LSL - M - L - L1	-	D3P2 - X - 2D - SC	-	HF - RF
Basic specification		Options: Aesthetics and Surface Enhancement		Options: Structural Changes

How to measure : See page 147

Male, L1

Model 200 series and Single finger (pg:50)

Thickness: 1-1.8mm

(mm)

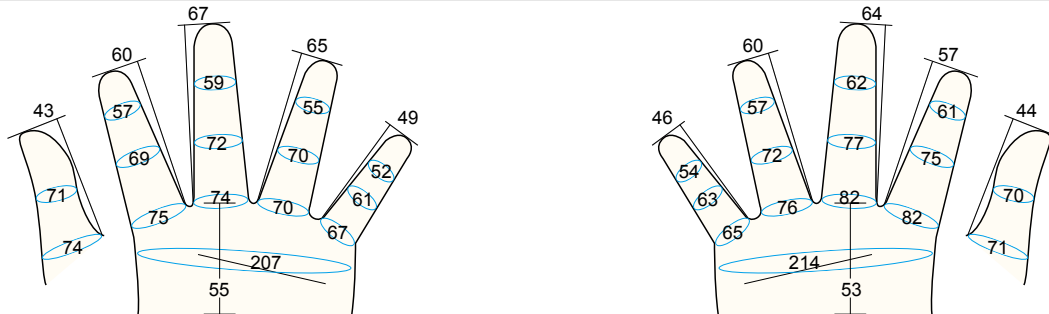

Model 103 (pg:49)

Thickness: 2-2.5mm

(mm)

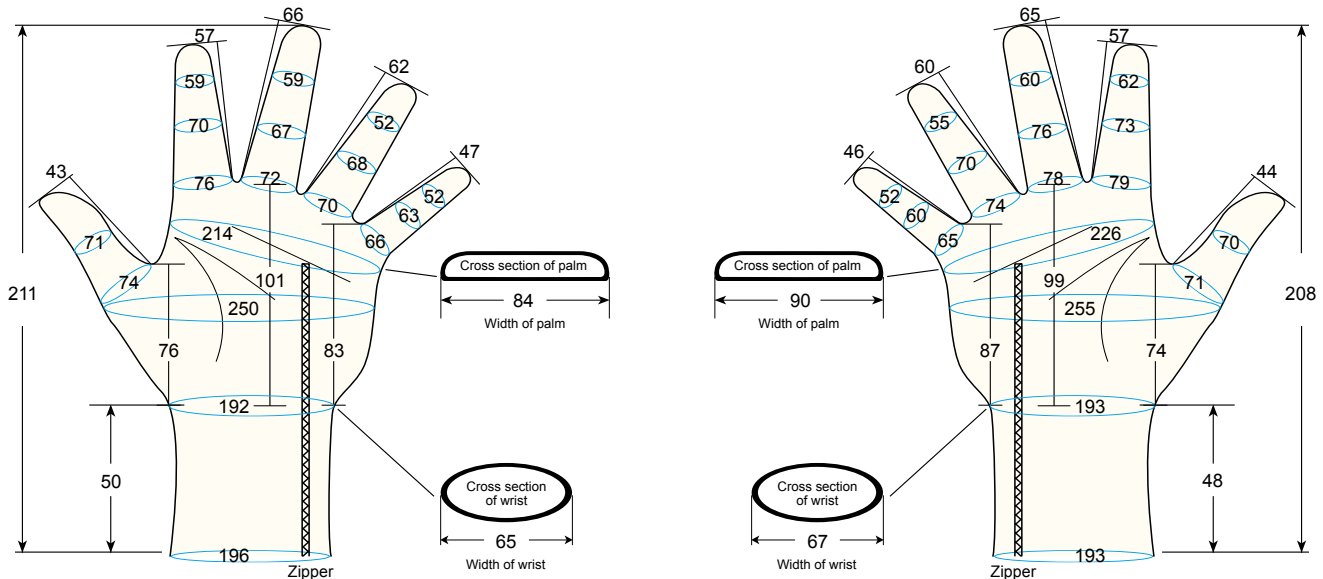

Model 101L, 102LS, 102L, 101LL, 102LSL, 102LL (pg:48)

Thickness: 2-2.5mm

(mm)

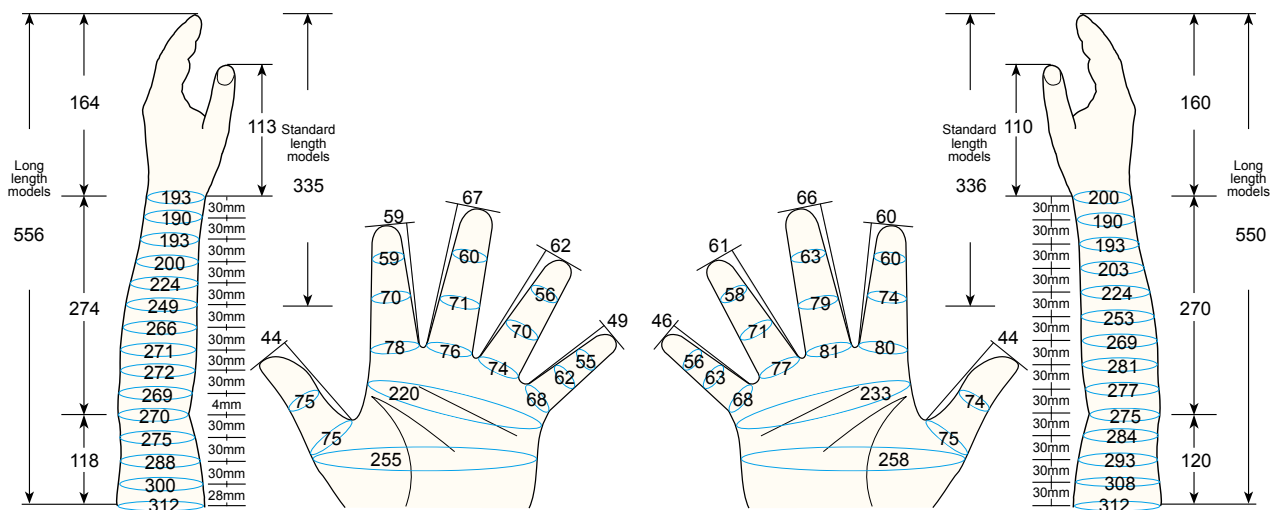

• All above information are for reference only •
• Please ask for more detail information •

Regal Silicone Prostheses

Product: Silicone prosthetic glove

Model: 101L, 102L, 102LS,
101LL, 102LL, 102LSL
103
200, Single finger

Size: Male, L2



✓ = Standard feature
O = Optional feature (no extra cost)
+ = Optional feature (extra cost)

Upgrade Option

Myo-Electric & Mechanical Gloves

Gloves, Passive & Partial Hands, Digits

Footcovers

Leg / Arm Sleeve Maxillofacial / Accessories

FAQ & Warranty

Product Structure (List of all available features of each Model and Size)

Product features description				Models					
Code				101L, 101LL	102L, 102LL	102LS, 102LSL	103	200 & Finger	
Basic Spec	Gender, Size			M-L2	✓	✓	✓	✓	
	Side			L / R	✓	✓	✓	✓	
	Color - Single (use color sample from Regal)				✓	✓	✓	✓	
Semi-Custom Made (p.7)				SCM	+	+	+	+	
Options: Aesthetics and Surface Enhancement	Color (p.14)	Dual Coloring Dorsal / Palmar (use color sample from Regal)		D/P	+	+	+	+	
		Custom Coloring (color sample is required)		CC	+	+	+	+	
	Nails, Hairs	X Series (p.16)		X	+	+	+	+	
		- Hair Dimension (available only when selecting X series)		2D / 3D	+	+	+	+	
		- Hair Color (available only when selecting X series) BB (Brown-Black), BR (Brown), BL (Black)		BB/BR /BL	+	+	+	+	
		Acrylic Nails (p.17)		ACRN					
	Smooth Coating	Smooth Coating (p.19)		SC	+	+	+	+	
Options: Structural Changes	Wrist Connector (p.20)	- External threaded stud, Metric		EX-MT			✓		
		- Internal , Metric		IN-MT			O		
		- External threaded stud, Imperial		EX-IP			O		
		- Internal, Imperial		IN-IP			O		
	Custom Filling (p.21)	- Foam		F		+		+	
		- Silicone		S		+		+	
		- Foam and Silicone		F+S		+		+	
	Fingers Construction (p.23)	Wired Fingers	(with filling)	(available depends on the length of the residual limb p.21)	W		✓	✓	
		Hinged Fingers		(available depends on the size of Silicone Prostheses & the length of residual limb p.23)	HF		+	+	+
		Reinforced Fingers * fingers with RF may be larger in circumference * not available when selecting SCM option			RF	+	+	+	
Fingers Bend (available only when selecting SCM) B1 (Straight), B2 (Standard) , B3 (Extra Bend)			B1/B2 /B3				+		
Zipper	Zipper (p.25) (plastic)		PZ	+	+	+	✓		
	Glue To Socket (p.25) (prosthetic socket is required)		GTS		+	+			

How to order : See page 146

Please use the product codes from previous page.

Example:

102LSL - M - L - L2	-	D3P2 - X - 2D - SC	-	HF - RF
Basic specification		Options: Aesthetics and Surface Enhancement		Options: Structural Changes

How to measure : See page 147

Male, L2

Model 200 series and Single finger (pg:50)

Thickness: 1-1.8mm

(mm)

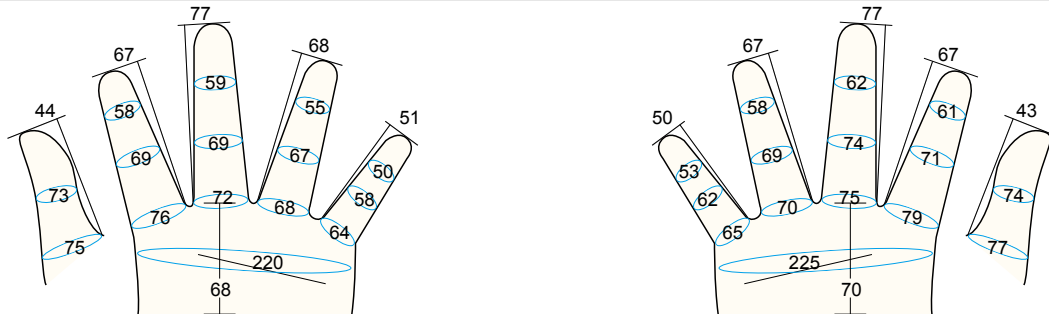

Model 103 (pg:49)

Thickness: 2-2.5mm

(mm)

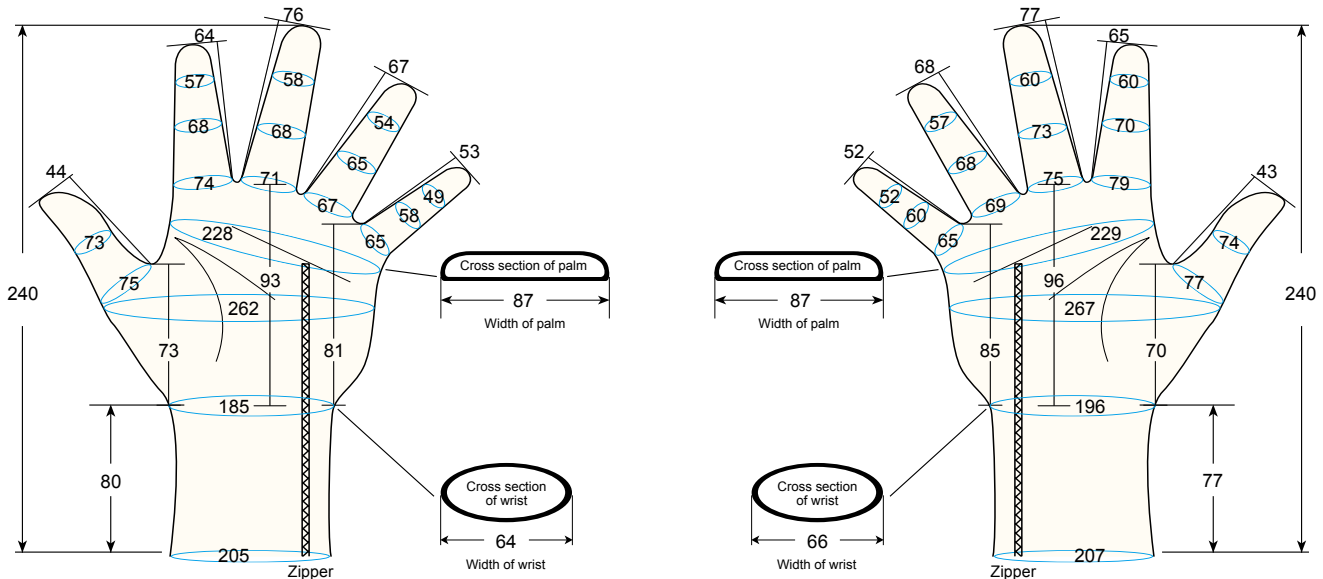

Model 101L, 102LS, 102L, 101LL, 102LSL, 102LL (pg:48)

Thickness: 2-2.5mm

(mm)

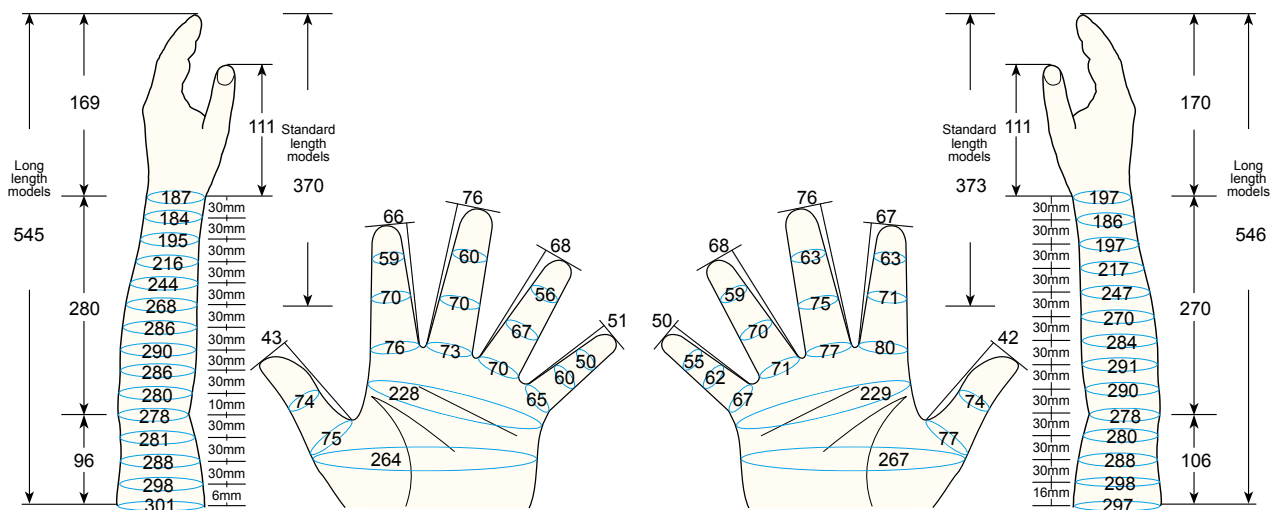

• All above information are for reference only •
• Please ask for more detail information •

Regal Silicone Prostheses

Product: Silicone prosthetic glove

Model: 101L, 102L, 102LS,
101LL, 102LL, 102LSL
103
200, Single finger

Size: Male, LM
Female, XL



✓ = Standard feature
O = Optional feature (no extra cost)
+ = Optional feature (extra cost)

Product Structure (List of all available features of each Model and Size)

Product features description				Models					
Code				101L, 101LL	102L, 102LL	102LS, 102LSL	103	200 & Finger	
Basic Spec	Gender, Size (Code: M-LM / F-XL)			✓	✓	✓	✓	✓	
	Side			L / R	✓	✓	✓	✓	
	Color - Single (use color sample from Regal)			✓	✓	✓	✓	✓	
Semi-Custom Made (p.7)			SCM	+	+	+	+	+	
Options: Aesthetics and Surface Enhancement	Color (p.14)	Dual Coloring Dorsal / Palmar (use color sample from Regal)		D/P	+	+	+	+	
		Custom Coloring (color sample is required)		CC	+	+	+	+	
	Nails, Hairs	X Series (p.16)		X	+	+	+	+	
		- Hair Dimension (available only when selecting X series)		2D / 3D	+	+	+	+	
		- Hair Color (available only when selecting X series) BB (Brown-Black), BR (Brown), BL (Black)		BB/BR /BL	+	+	+	+	
		Acrylic Nails (p.17)		ACRN	+	+	+	+	
	Smooth Coating	Smooth Coating (p.19)		SC	+	+	+	+	
Options: Structural Changes	Wrist Connector (p.20)	- External threaded stud, Metric		EX-MT			✓		
		- Internal , Metric		IN-MT			O		
		- External threaded stud, Imperial		EX-IP			O		
		- Internal, Imperial		IN-IP			O		
	Custom Filling (p.21)	- Foam		F		+		+	
		- Silicone		S		+		+	
		- Foam and Silicone (available depends on the length of the residual limb p.21)		F+S		+		+	
	Fingers Construction (p.23)	Wired Fingers	(with filling)	(available depends on the size of Silicone Prostheses & the length of residual limb p.23)	W		✓	✓	O
		Hinged Fingers			HF		+	+	+
		Reinforced Fingers * fingers with RF may be larger in circumference * not available when selecting SCM option			RF	+	+	+	
Fingers Bend (available only when selecting SCM) B1 (Straight), B2 (Standard) , B3 (Extra Bend)			B1/B2 /B3					+	
Zipper	Zipper (p.25) (plastic)		PZ	+	+	+	✓		
Glue To Socket (p.25) (prosthetic socket is required)			GTS		+	+			

How to order : See page 146

Please use the product codes from previous page.

Example:

102LSL - M - L - LM	-	D3P2 - X - 2D - SC	-	HF - RF
---------------------	---	--------------------	---	---------

Basic specification

Options:
Aesthetics and Surface Enhancement

Options:
Structural Changes

How to measure : See page 147

Male, LM / Female, XL

Model 200 series and Single finger (pg:50)

Thickness: 1-1.8mm

(mm)

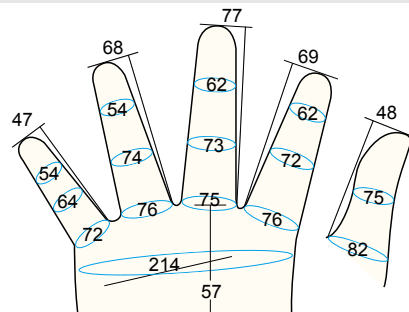
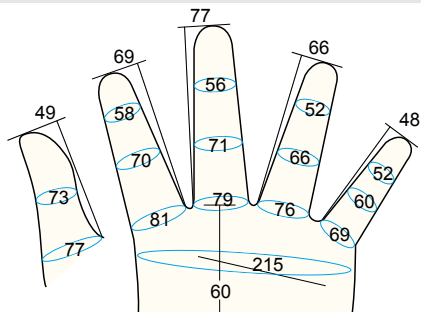

Model 103 (pg:49)

Thickness: 2-2.5mm

(mm)

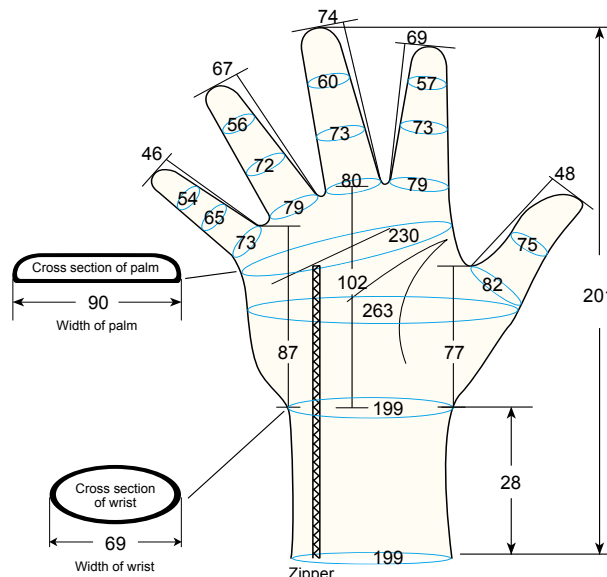
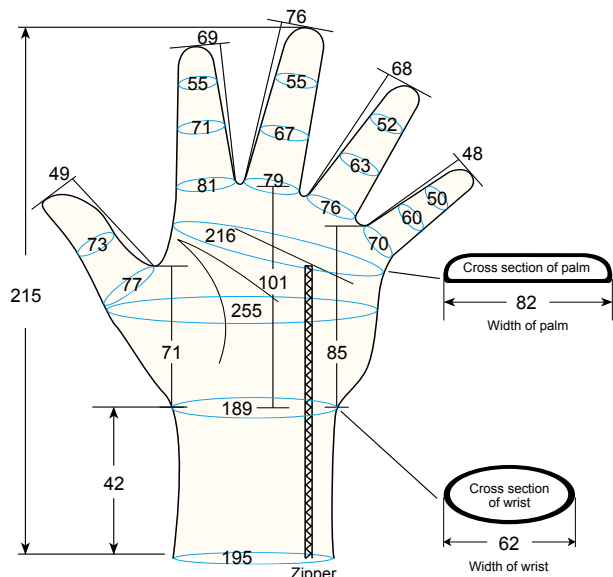

Model 101L, 102LS, 102L, 101LL, 102LSL, 102LL (pg:48)

Thickness: 2-2.5mm

(mm)

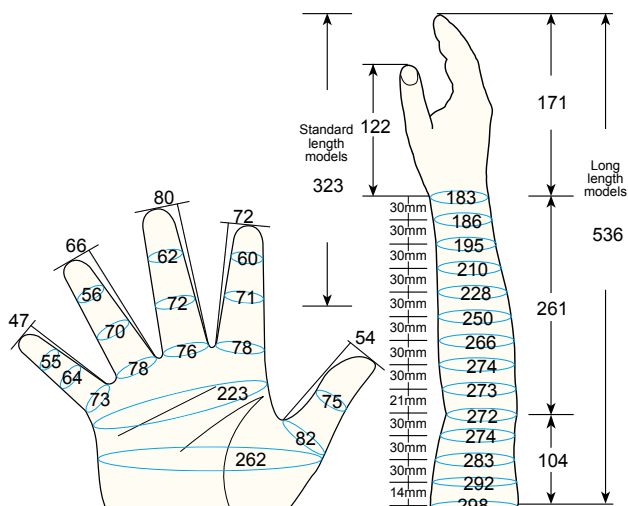
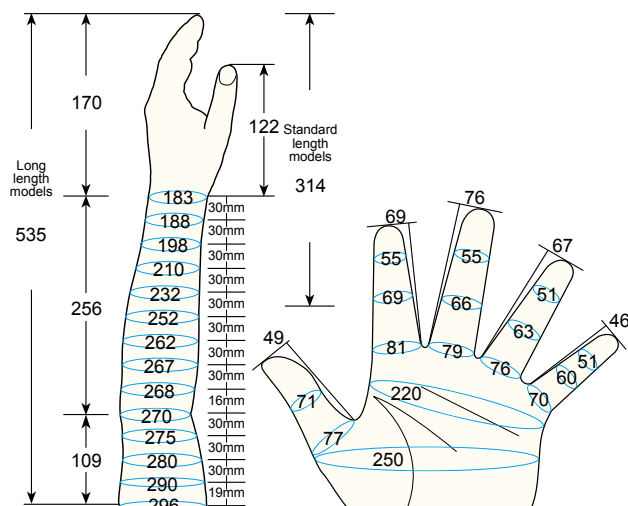

• All above information are for reference only •
• Please ask for more detail information •

Regal Silicone Prostheses

Product: Silicone prosthetic glove

Model: 101L, 102L, 102LS,
101LL, 102LL, 102LSL
103
200, Single finger

Size: Male, M



✓ = Standard feature
O = Optional feature (no extra cost)
+ = Optional feature (extra cost)

Upgrade Option

Myo-Electric & Mechanical Gloves

Gloves, Passive & Partial Hands, Digits

Footcovers

Leg / Arm Sleeve Maxillofacial / Accessories

FAQ & Warranty

Product Structure (List of all available features of each Model and Size)

Product features description				Models				
Code				101L, 101LL	102L, 102LL	102LS, 102LSL	103	200 & Finger
Basic Spec	Gender, Size			M-M	✓	✓	✓	✓
	Side			L / R	✓	✓	✓	✓
	Color - Single (use color sample from Regal)				✓	✓	✓	✓
Semi-Custom Made (p.7)				SCM	+	+	+	+
Options: Aesthetics and Surface Enhancement	Color (p.14)	Dual Coloring Dorsal / Palmar (use color sample from Regal)		D/P	+	+	+	+
		Custom Coloring (color sample is required)		CC	+	+	+	+
	Nails, Hairs	X Series (p.16)		X	+	+	+	+
		- Hair Dimension (available only when selecting X series)		2D / 3D	+	+	+	+
		- Hair Color (available only when selecting X series) BB (Brown-Black), BR (Brown), BL (Black)		BB/BR /BL	+	+	+	+
		Acrylic Nails (p.17)		ACRN				
	Smooth Coating	Smooth Coating (p.19)		SC	+	+	+	+
Options: Structural Changes	Wrist Connector (p.20)	- External threaded stud, Metric		EX-MT			✓	
		- Internal, Metric		IN-MT			O	
		- External threaded stud, Imperial		EX-IP			O	
		- Internal, Imperial		IN-IP			O	
	Custom Filling (p.21)	- Foam		F		+		+
		- Silicone		S		+		+
		- Foam and Silicone		(available depends on the length of the residual limb p.21) F+S		+		+
	Fingers Construction (p.23)	Wired Fingers	(with filling)	(available depends on the size of Silicone Prostheses & the length of residual limb p.23) W		✓	✓	
		Hinged Fingers		HF		+	+	+
		Reinforced Fingers * fingers with RF may be larger in circumference * not available when selecting SCM option		RF	+	+	+	
Fingers Bend (available only when selecting SCM) B1 (Straight), B2 (Standard), B3 (Extra Bend)		B1/B2 /B3				+		
Zipper	Zipper (p.25) (plastic)		PZ	+	+	+	✓	
	Glue To Socket (p.25) (prosthetic socket is required)		GTS		+	+		

How to order : See page 146

Please use the product codes from previous page.

Example:

102LSL - M - L - M	-	D3P2 - X - 2D - SC	-	HF - RF
Basic specification		Options: Aesthetics and Surface Enhancement	Options: Structural Changes	

How to measure : See page 147

Male, M

Model 200 series and Single finger (pg:50)

Thickness: 1-1.8mm

(mm)

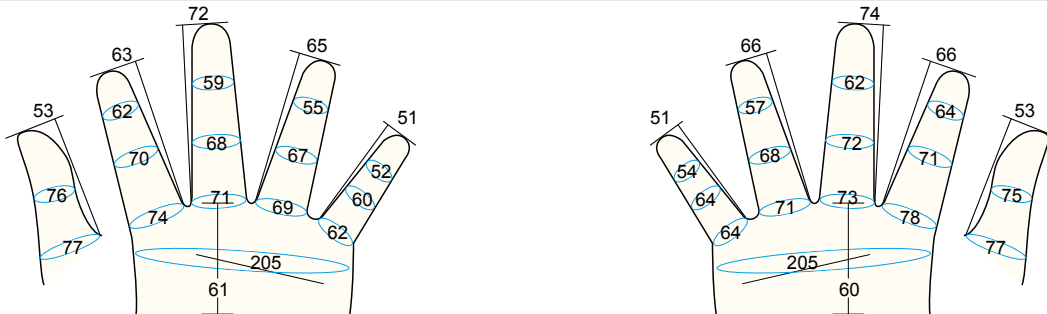

Model 103 (pg:49)

Thickness: 2-2.5mm

(mm)

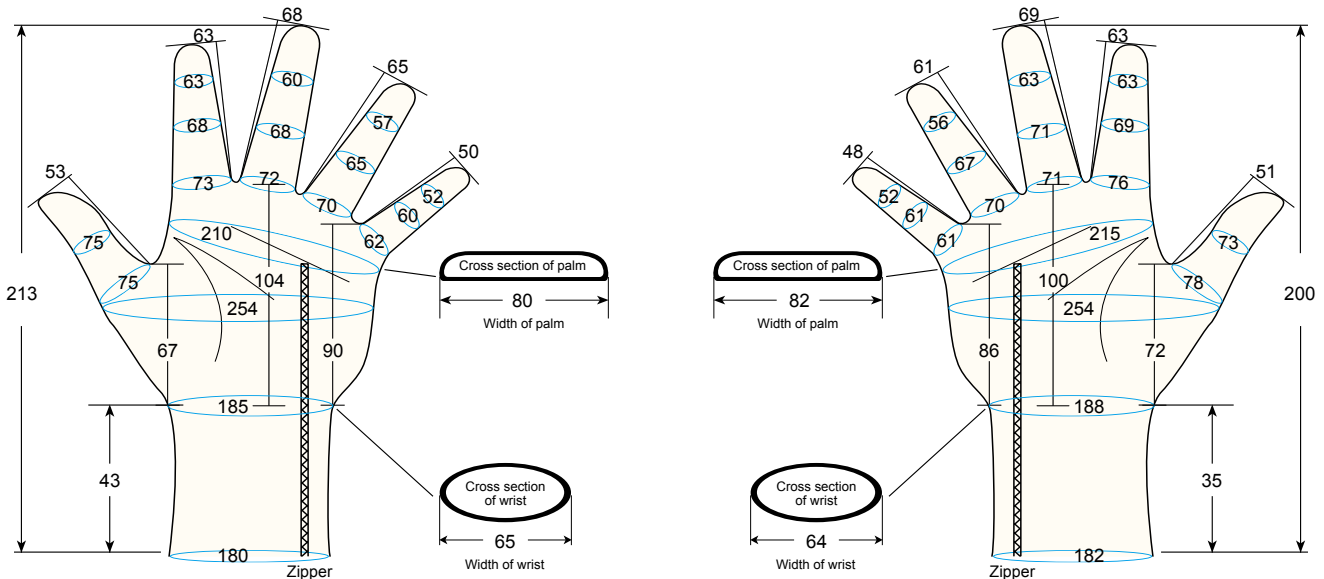

Model 101L, 102LS, 102L, 101LL, 102LSL, 102LL (pg:48)

Thickness: 2-2.5mm

(mm)

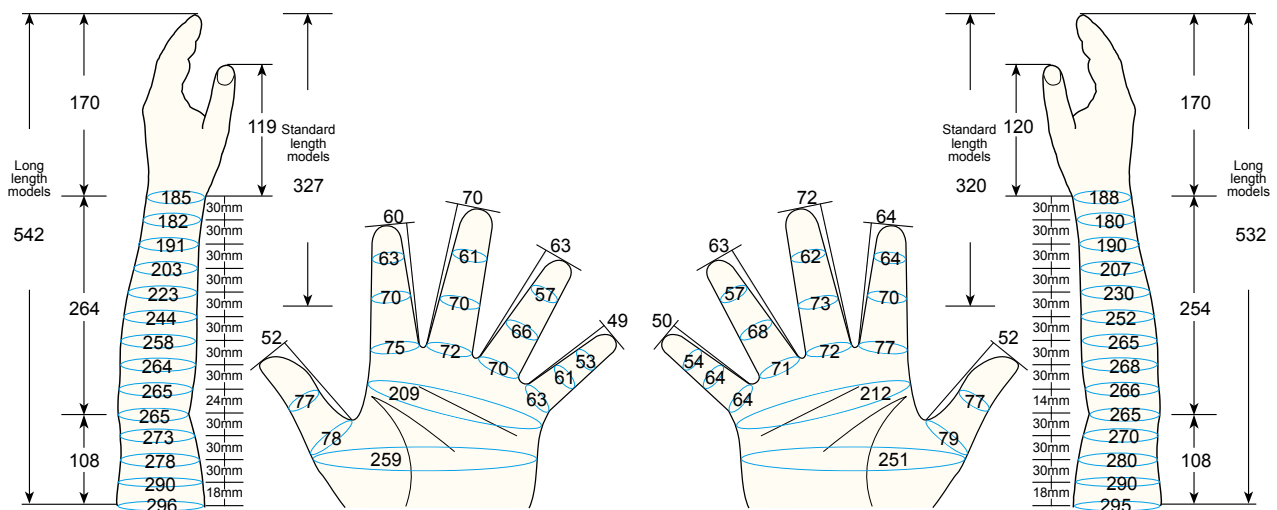

• All above information are for reference only •
• Please ask for more detail information •

Regal Silicone Prostheses

Product: Silicone prosthetic glove

Model: 101L, 102L, 102LS,
101LL, 102LL, 102LSL
103
200, Single finger

Size: Male, M1



✓ = Standard feature
O = Optional feature (no extra cost)
+ = Optional feature (extra cost)

Upgrade Option

Myo-Electric & Mechanical Gloves

Gloves, Passive & Partial Hands, Digits

Footcovers

Leg / Arm Sleeve Maxillofacial / Accessories

FAQ & Warranty

Product Structure (List of all available features of each Model and Size)

Product features description				Models				
Code				101L, 101LL	102L, 102LL	102LS, 102LSL	103	200 & Finger
Basic Spec	Gender, Size		M-M1	✓	✓	✓	✓	✓
	Side		L / R	✓	✓	✓	✓	✓
	Color - Single (use color sample from Regal)			✓	✓	✓	✓	✓
Semi-Custom Made (p.7)			SCM	+	+	+	+	+
Options: Aesthetics and Surface Enhancement	Color (p.14)	Dual Coloring Dorsal / Palmar (use color sample from Regal)		D/P	+	+	+	+
		Custom Coloring (color sample is required)		CC	+	+	+	+
	Nails, Hairs	X Series (p.16)		X	+	+	+	+
		- Hair Dimension (available only when selecting X series)		2D / 3D	+	+	+	+
		- Hair Color (available only when selecting X series) BB (Brown-Black), BR (Brown), BL (Black)		BB/BR /BL	+	+	+	+
		Acrylic Nails (p.17)		ACRN				
	Smooth Coating	Smooth Coating (p.19)		SC	+	+	+	+
Options: Structural Changes	Wrist Connector (p.20)	- External threaded stud, Metric		EX-MT			✓	
		- Internal , Metric		IN-MT			O	
		- External threaded stud, Imperial		EX-IP			O	
		- Internal, Imperial		IN-IP			O	
	Custom Filling (p.21)	- Foam		F		+		+
		- Silicone		S		+		+
		- Foam and Silicone		F+S		+		+
	Fingers Construction (p.23)	Wired Fingers	(with filling)	(available depends on the length of the residual limb p.21)	W		✓	
		Hinged Fingers		(available depends on the size of Silicone Prostheses & the length of residual limb p.23)	HF		+	+
		Reinforced Fingers * fingers with RF may be larger in circumference * not available when selecting SCM option		RF	+	+	+	
Fingers Bend (available only when selecting SCM) B1 (Straight), B2 (Standard) , B3 (Extra Bend)		B1/B2 /B3					+	
Zipper	Zipper (p.25) (plastic)		PZ	+	+	+	✓	
	Glue To Socket (p.25) (prosthetic socket is required)		GTS		+	+		

How to order : See page 146

Please use the product codes from previous page.

Example:

102LSL - M - L - M1	-	D3P2 - X - 2D - SC	-	HF - RF
Basic specification		Options: Aesthetics and Surface Enhancement	Options: Structural Changes	

How to measure : See page 147

Male, M1

Model 200 series and Single finger (pg:50)

Thickness: 1-1.8mm

(mm)

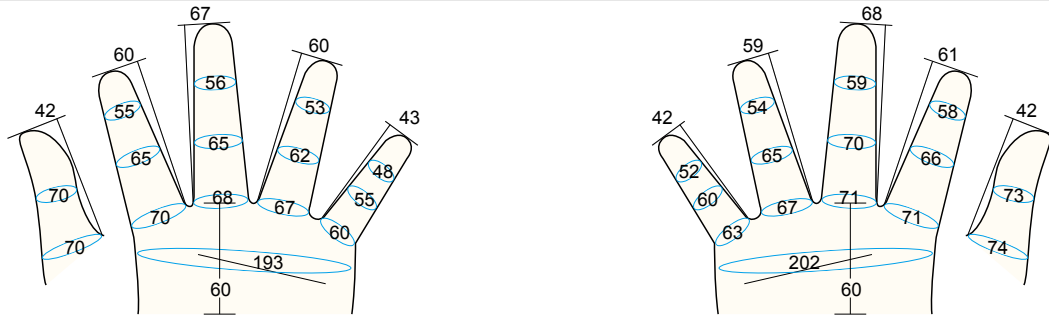

Model 103 (pg:49)

Thickness: 2-2.5mm

(mm)

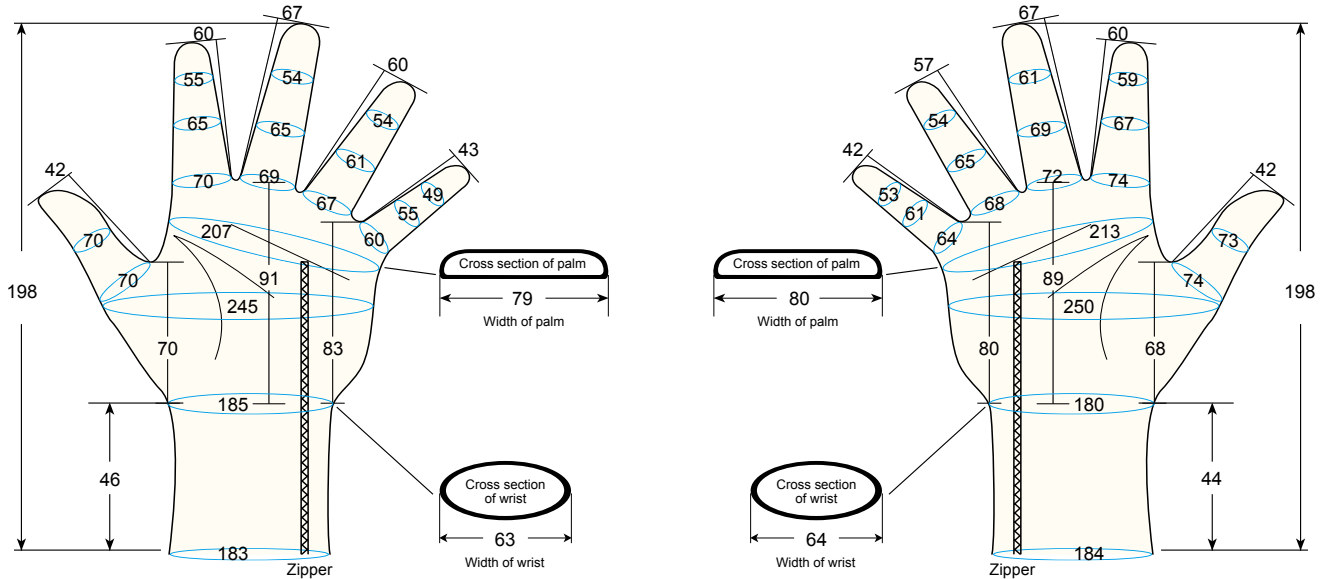

Model 101L, 102LS, 102L, 101LL, 102LSL, 102LL (pg:48)

Thickness: 2-2.5mm

(mm)

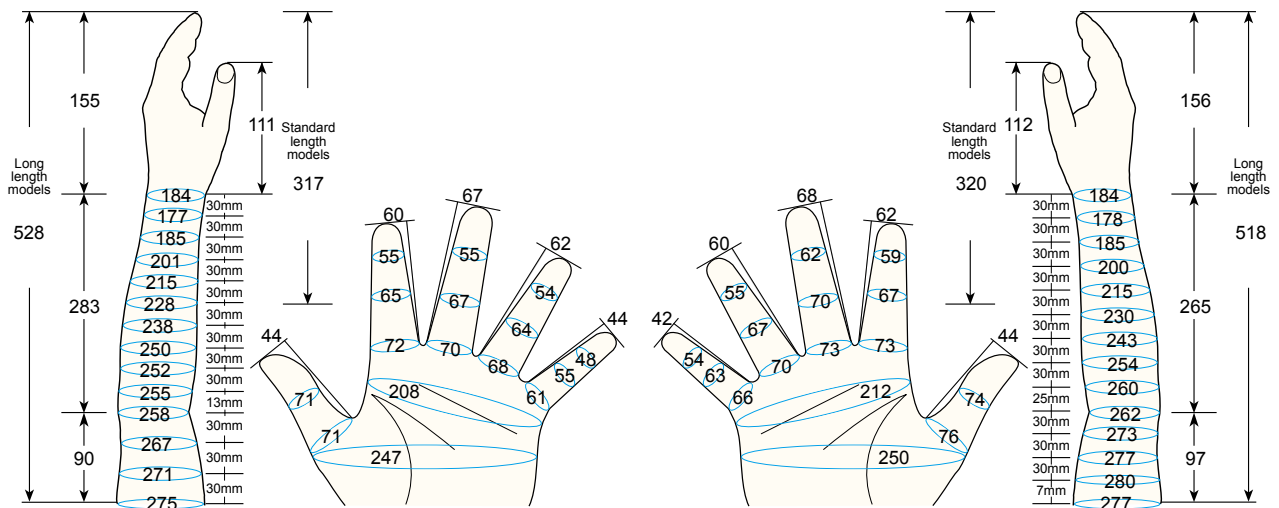

• All above information are for reference only •
• Please ask for more detail information •

Regal Silicone Prostheses

Product: Silicone prosthetic glove

Model: 101L, 102L, 102LS,
101LL, 102LL, 102LSL
103
200, Single finger

Size: Male, M2
Female, L1



✓ = Standard feature
O = Optional feature (no extra cost)
+ = Optional feature (extra cost)

Product Structure (List of all available features of each Model and Size)

Product features description				Models					
Code				101L, 101LL	102L, 102LL	102LS, 102LSL	103	200 & Finger	
Basic Spec	Gender, Size (Code: M-M2 / F-L1)			✓	✓	✓	✓	✓	
	Side			L / R	✓	✓	✓	✓	
	Color - Single (use color sample from Regal)			✓	✓	✓	✓	✓	
Semi-Custom Made (p.7)			SCM	+	+	+	+	+	
Options: Aesthetics and Surface Enhancement	Color (p.14)	Dual Coloring Dorsal / Palmar (use color sample from Regal)		D/P	+	+	+	+	
		Custom Coloring (color sample is required)		CC	+	+	+	+	
	Nails, Hairs	X Series (p.16)		X	+	+	+	+	
		- Hair Dimension (available only when selecting X series)		2D / 3D	+	+	+	+	
		- Hair Color (available only when selecting X series) BB (Brown-Black), BR (Brown), BL (Black)		BB/BR /BL	+	+	+	+	
		Acrylic Nails (p.17)		ACRN	+	+	+	+	
	Smooth Coating	Smooth Coating (p.19)		SC	+	+	+	+	
Options: Structural Changes	Wrist Connector (p.20)	- External threaded stud, Metric		EX-MT			✓		
		- Internal , Metric		IN-MT			O		
		- External threaded stud, Imperial		EX-IP			O		
		- Internal, Imperial		IN-IP			O		
	Custom Filling (p.21)	- Foam		F		+		+	
		- Silicone		S		+		+	
		- Foam and Silicone (available depends on the length of the residual limb p.21)		F+S		+		+	
	Fingers Construction (p.23)	Wired Fingers	(with filling)	(available depends on the size of Silicone Prostheses & the length of residual limb p.23)	W		✓	✓	
		Hinged Fingers			HF		+	+	+
		Reinforced Fingers * fingers with RF may be larger in circumference * not available when selecting SCM option			RF	+	+	+	
Fingers Bend (available only when selecting SCM) B1 (Straight), B2 (Standard) , B3 (Extra Bend)			B1/B2 /B3				+		
Zipper	Zipper (p.25) (plastic)		PZ	+	+	+	✓		
Glue To Socket (p.25) (prosthetic socket is required)			GTS		+	+			

How to order : See page 146

Please use the product codes from previous page.

Example:

102LSL - M - L - M2	-	D3P2 - X - 2D - SC	-	HF - RF
---------------------	---	--------------------	---	---------

Basic specification

Options:
Aesthetics and Surface Enhancement

Options:
Structural Changes

How to measure : See page 147

Male, M2 / Female, L1

Model 200 series and Single finger (pg:50)

Thickness: 1-1.8mm

(mm)

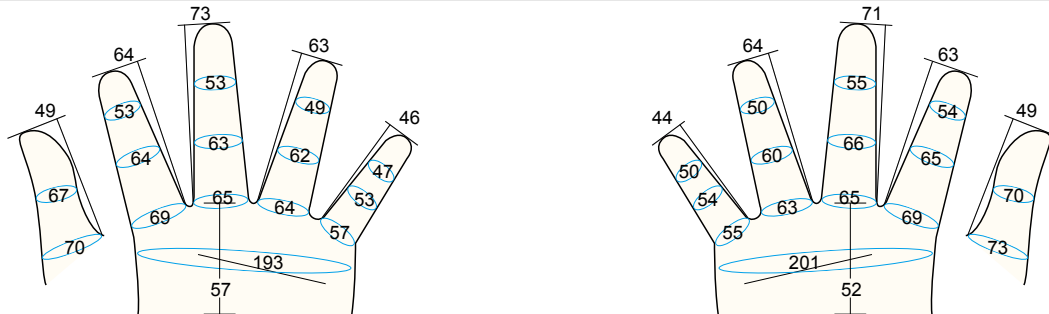

Model 103 (pg:49)

Thickness: 2-2.5mm

(mm)

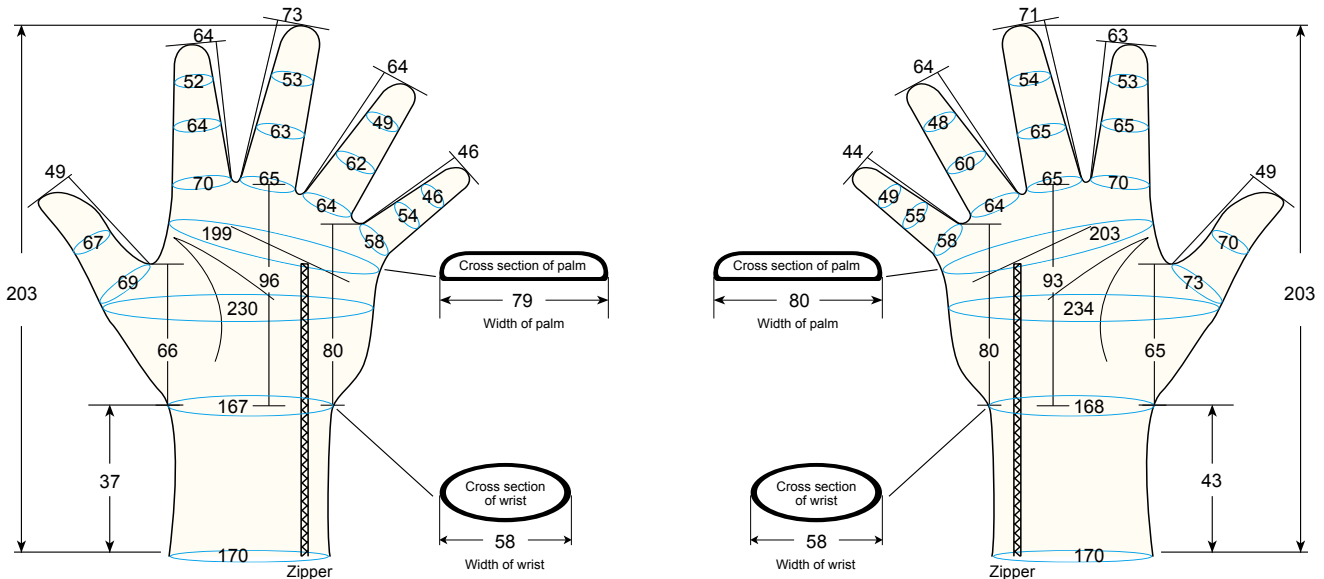

Model 101L, 102LS, 102L, 101LL, 102LSL, 102LL (pg:48)

Thickness: 2-2.5mm

(mm)

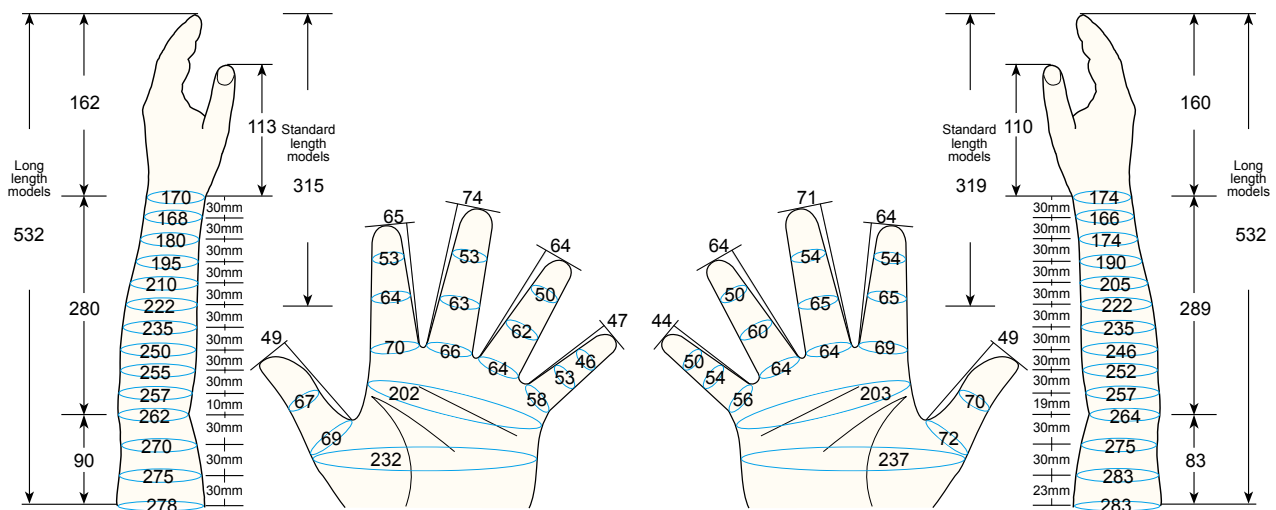

• All above information are for reference only •
• Please ask for more detail information •

Regal Silicone Prostheses

Upgrade Option

Myo-Electric & Mechanical Gloves

Gloves, Passive & Partial Hands, Digits

Footcovers

Leg / Arm Sleeve Maxillofacial / Accessories

FAQ & Warranty

Product: Silicone prosthetic glove

Model: 101L, 102L, 102LS, 101LL, 102LL, 102LSL, 103, 200, Single finger

Size: Male, M3



- ✓ = Standard feature
- O = Optional feature (no extra cost)
- + = Optional feature (extra cost)

Product Structure (List of all available features of each Model and Size)

Product features description				Models				
Basic Spec	Code	101L, 101LL	102L, 102LL	102LS, 102LSL	103	200 & Finger		
Gender, Size	M-M3	✓	✓	✓	✓	✓	✓	
Side	L / R	✓	✓	✓	✓	✓	✓	
Color - Single (use color sample from Regal)		✓	✓	✓	✓	✓	✓	
Semi-Custom Made (p.7)	SCM	+	+	+	+	+	+	
Options: Aesthetics and Surface Enhancement	Color (p.14)	Dual Coloring Dorsal / Palmar (use color sample from Regal)	D/P	+	+	+	+	+
		Custom Coloring (color sample is required)	CC	+	+	+	+	+
	Nails, Hairs	X Series (p.16)	X	+	+	+	+	+
		- Hair Dimension (available only when selecting X series)	2D / 3D	+	+	+	+	+
		- Hair Color (available only when selecting X series) BB (Brown-Black), BR (Brown), BL (Black)	BB/BR /BL	+	+	+	+	+
		Acrylic Nails (p.17)	ACRN					
Smooth Coating	Smooth Coating (p.19)	SC	+	+	+	+	+	
Options: Structural Changes	Wrist Connector (p.20)	- External threaded stud, Metric	EX-MT			✓		
		- Internal, Metric	IN-MT			O		
		- External threaded stud, Imperial	EX-IP			O		
		- Internal, Imperial	IN-IP			O		
	Custom Filling (p.21)	- Foam	F		+		+	+
		- Silicone	S		+		+	+
		- Foam and Silicone	F+S		+		+	+
	Fingers Construction (p.23)	Wired Fingers	(with filling) (available depends on the length of the residual limb p.21)	W		✓	✓	
		Hinged Fingers	(available depends on the size of Silicone Prostheses & the length of residual limb p.23)	HF		+	+	+
		Reinforced Fingers * fingers with RF may be larger in circumference * not available when selecting SCM option	RF	+	+	+		
Fingers Bend (available only when selecting SCM) B1 (Straight), B2 (Standard), B3 (Extra Bend)		B1/B2 /B3					+	
Zipper	Zipper (p.25) (plastic)	PZ	+	+	+	✓		
	Glue To Socket (p.25) (prosthetic socket is required)	GTS		+	+			

How to order : See page 146

Please use the product codes from previous page.

Example:

102LSL - M - L - M3	-	D3P2 - X - 2D - SC	-	HF - RF
---------------------	---	--------------------	---	---------

Basic specification

Options:
Aesthetics and Surface Enhancement

Options:
Structural Changes

How to measure : See page 147

Male, M3

Model 200 series and Single finger (pg:50)

Thickness: 1-1.8mm

(mm)

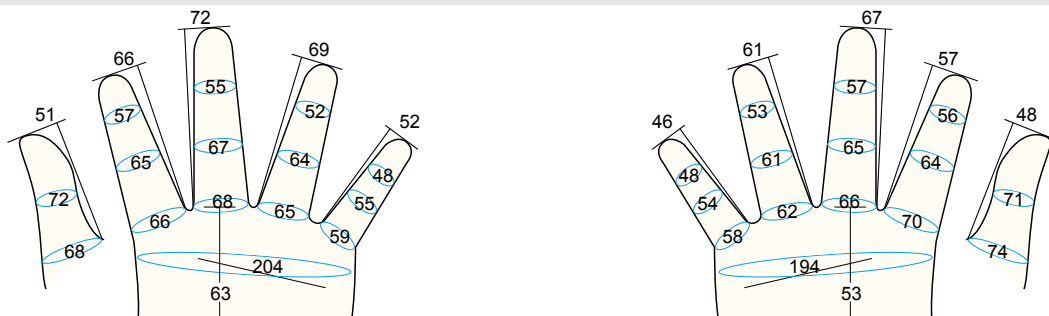

Model 103 (pg:49)

Thickness: 2-2.5mm

(mm)

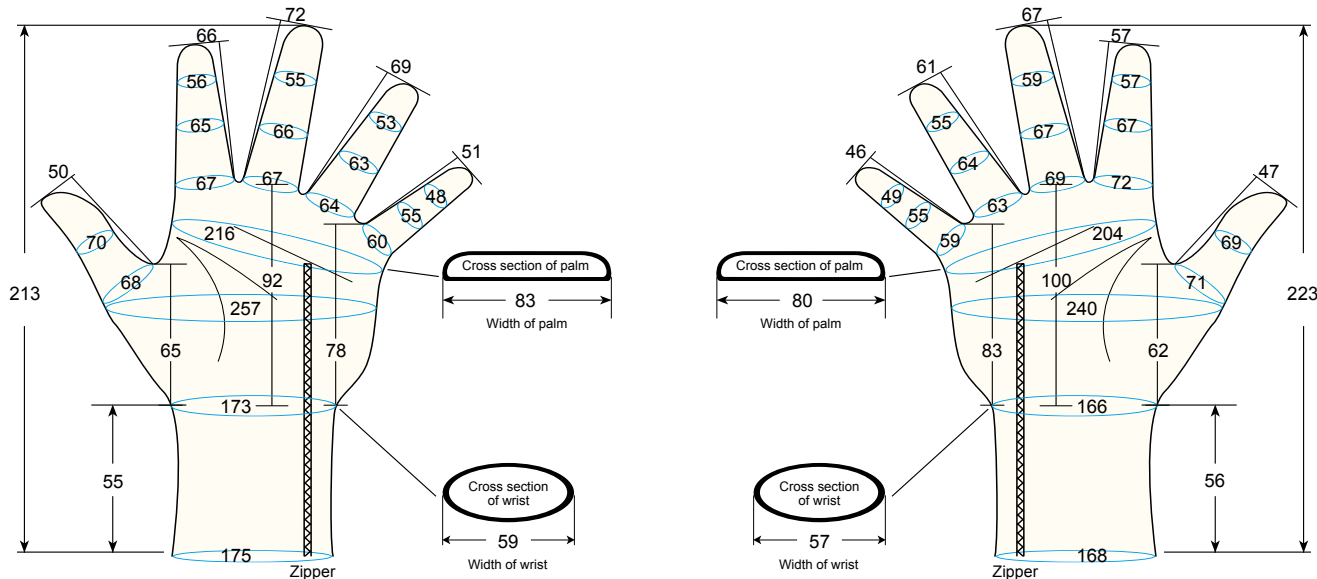

Model 101L, 102LS, 102L, 101LL, 102LSL, 102LL (pg:48)

Thickness: 2-2.5mm

(mm)

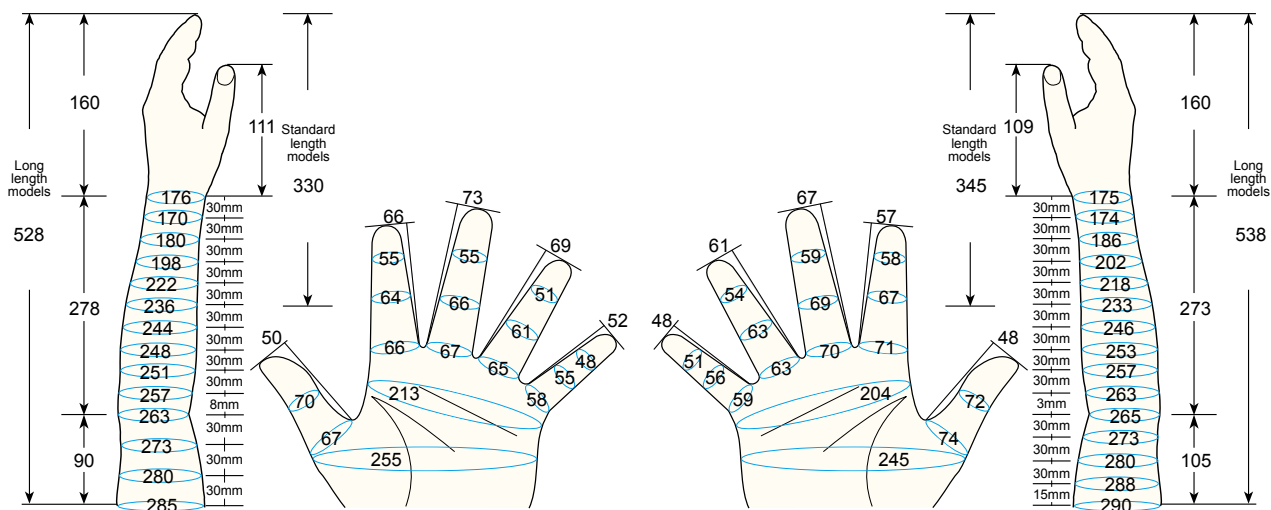

• All above information are for reference only •
• Please ask for more detail information •

Regal Silicone Prostheses

Product: Silicone prosthetic glove

Model: 101L, 102L, 102LS,
101LL, 102LL, 102LSL
103
200, Single finger

Size: Male, M4



✓ = Standard feature
O = Optional feature (no extra cost)
+ = Optional feature (extra cost)

Upgrade Option

Myo-Electric & Mechanical Gloves

Gloves, Passive & Partial Hands, Digits

Footcovers

Leg / Arm Sleeve Maxillofacial / Accessories

FAQ & Warranty

Product Structure (List of all available features of each Model and Size)

Product features description				Models					
Code				101L, 101LL	102L, 102LL	102LS, 102LSL	103	200 & Finger	
Basic Spec	Gender, Size			M-M3	✓	✓	✓	✓	✓
	Side			L / R	✓	✓	✓	✓	✓
	Color - Single (use color sample from Regal)				✓	✓	✓	✓	✓
Semi-Custom Made (p.7)				SCM	+	+	+	+	+
Options: Aesthetics and Surface Enhancement	Color (p.14)	Dual Coloring Dorsal / Palmar (use color sample from Regal)		D/P	+	+	+	+	+
		Custom Coloring (color sample is required)		CC	+	+	+	+	+
	Nails, Hairs	X Series (p.16)			X	+	+	+	+
		- Hair Dimension (available only when selecting X series)		2D / 3D	+	+	+	+	+
		- Hair Color (available only when selecting X series) BB (Brown-Black), BR (Brown), BL (Black)		BB/BR /BL	+	+	+	+	+
		Acrylic Nails (p.17)			ACRN				
	Smooth Coating	Smooth Coating (p.19)			SC	+	+	+	+
Options: Structural Changes	Wrist Connector (p.20)	- External threaded stud, Metric		EX-MT			✓		
		- Internal, Metric		IN-MT			O		
		- External threaded stud, Imperial		EX-IP			O		
		- Internal, Imperial		IN-IP			O		
	Custom Filling (p.21)	- Foam		F		+		+	+
		- Silicone		S		+		+	+
		- Foam and Silicone		(available depends on the length of the residual limb p.21) F+S		+		+	+
	Fingers Construction (p.23)	Wired Fingers	(with filling)	(available depends on the size of Silicone Prostheses & the length of residual limb p.23)	W		✓	✓	
		Hinged Fingers			HF		+	+	+
		Reinforced Fingers * fingers with RF may be larger in circumference * not available when selecting SCM option			RF	+	+	+	
Fingers Bend (available only when selecting SCM) B1 (Straight), B2 (Standard), B3 (Extra Bend)			B1/B2 /B3					+	
Zipper	Zipper (p.25) (plastic)			PZ	+	+	+	✓	
Glue To Socket (p.25) (prosthetic socket is required)				GTS		+	+		

How to order : See page 146

Please use the product codes from previous page.

Example:

102LSL - M - L - M4	-	D3P2 - X - 2D - SC	-	HF - RF
Basic specification		Options: Aesthetics and Surface Enhancement		Options: Structural Changes

How to measure : See page 147

Male, M4

Model 200 series and Single finger (pg:50) Thickness: 1-1.8mm (mm)

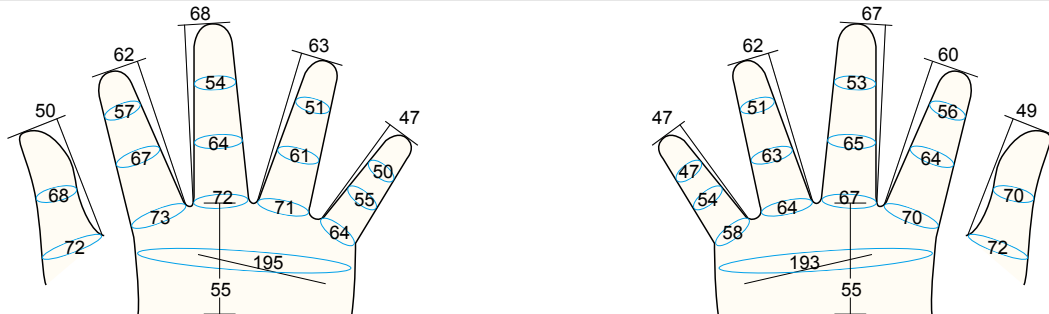

Model 103 (pg:49) Thickness: 2-2.5mm (mm)

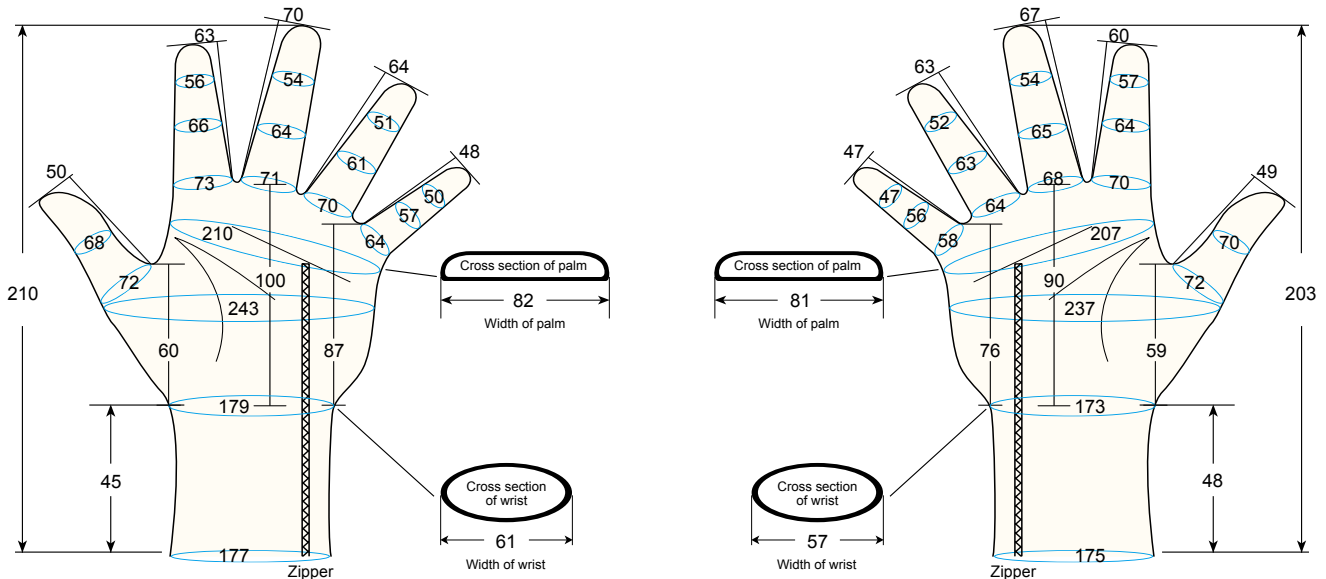

Model 101L, 102LS, 102L, 101LL, 102LSL, 102LL (pg:48) Thickness: 2-2.5mm (mm)

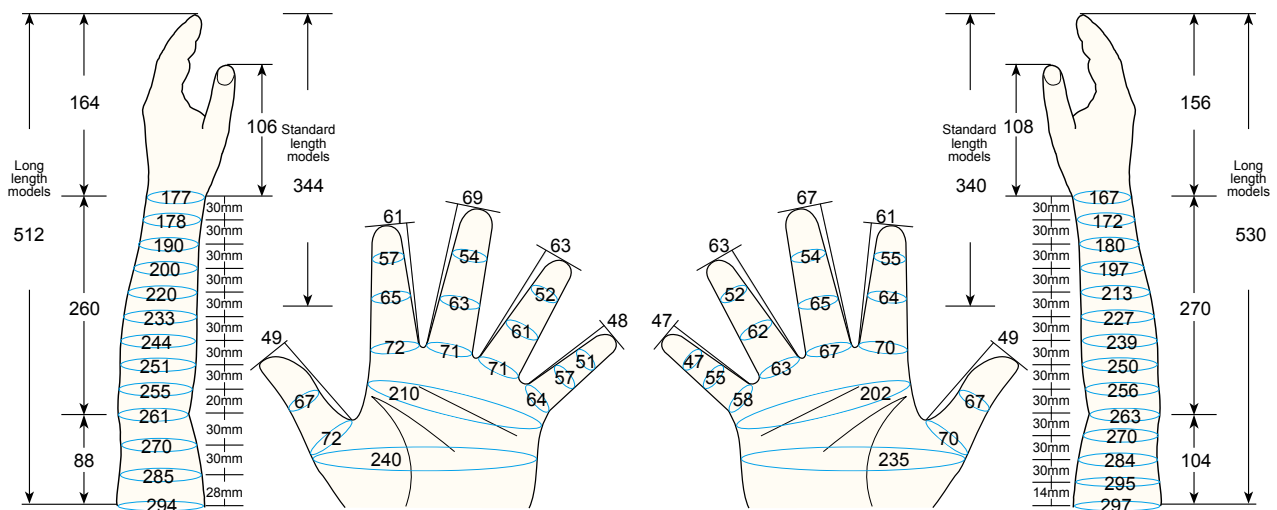

• All above information are for reference only •
• Please ask for more detail information •

Regal Silicone Prostheses

Upgrade Option

Myo-Electric & Mechanical Gloves

Gloves, Passive & Partial Hands, Digits

Footcovers

Leg / Arm Sleeve Maxillofacial / Accessories

FAQ & Warranty

Product: Silicone prosthetic glove

Model: 101L, 102L, 102LS, 101LL, 102LL, 102LSL, 103, 200, Single finger

Size: Male, MS, Female, LM



- ✓ = Standard feature
- O = Optional feature (no extra cost)
- + = Optional feature (extra cost)

Product Structure (List of all available features of each Model and Size)

Product features description				Models					
Code				101L, 101LL	102L, 102LL	102LS, 102LSL	103	200 & Finger	
Basic Spec	Gender, Size (Code: M-MS / F-LM)			✓	✓	✓	✓	✓	
	Side			L / R	✓	✓	✓	✓	
	Color - Single (use color sample from Regal)			✓	✓	✓	✓	✓	
Semi-Custom Made (p.7)			SCM	+	+	+	+	+	
Options: Aesthetics and Surface Enhancement	Color (p.14)	Dual Coloring Dorsal / Palmar (use color sample from Regal)		D/P	+	+	+	+	
		Custom Coloring (color sample is required)		CC	+	+	+	+	
	Nails, Hairs	X Series (p.16)		X	+	+	+	+	
		- Hair Dimension (available only when selecting X series)		2D / 3D	+	+	+	+	
		- Hair Color (available only when selecting X series) BB (Brown-Black), BR (Brown), BL (Black)		BB/BR /BL	+	+	+	+	
		Acrylic Nails (p.17)		ACRN	+	+	+	+	
	Smooth Coating	Smooth Coating (p.19)		SC	+	+	+	+	
Options: Structural Changes	Wrist Connector (p.20)	- External threaded stud, Metric		EX-MT			✓		
		- Internal, Metric		IN-MT			O		
		- External threaded stud, Imperial		EX-IP			O		
		- Internal, Imperial		IN-IP			O		
	Custom Filling (p.21)	- Foam		F		+		+	
		- Silicone		S		+		+	
		- Foam and Silicone (available depends on the length of the residual limb p.21)		F+S		+		+	
	Fingers Construction (p.23)	Wired Fingers	(with filling)	(available depends on the size of Silicone Prostheses & the length of residual limb p.23)	W		✓		
		Hinged Fingers			HF		+		+
		Reinforced Fingers * fingers with RF may be larger in circumference * not available when selecting SCM option			RF	+	+	+	
Fingers Bend (available only when selecting SCM) B1 (Straight), B2 (Standard), B3 (Extra Bend)			B1/B2 /B3					+	
Zipper	Zipper (p.25) (plastic)		PZ	+	+	+	✓		
Glue To Socket (p.25) (prosthetic socket is required)			GTS		+	+			

How to order : See page 146

Please use the product codes from previous page.

Example:

102LSL - M - L - MS	-	D3P2 - X - 2D - SC	-	HF - RF
---------------------	---	--------------------	---	---------

Basic specification

Options:
Aesthetics and Surface Enhancement

Options:
Structural Changes

How to measure : See page 147

Male, MS / Female, LM

Model 200 series and Single finger (pg:50)

Thickness: 1-1.8mm

(mm)

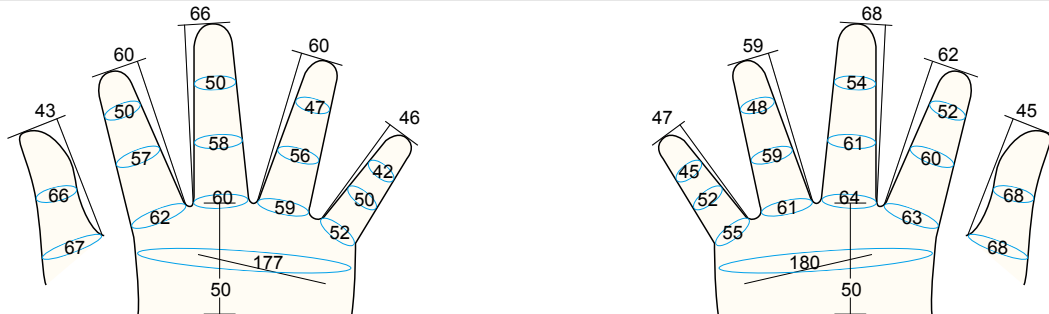

Model 103 (pg:49)

Thickness: 2-2.5mm

(mm)

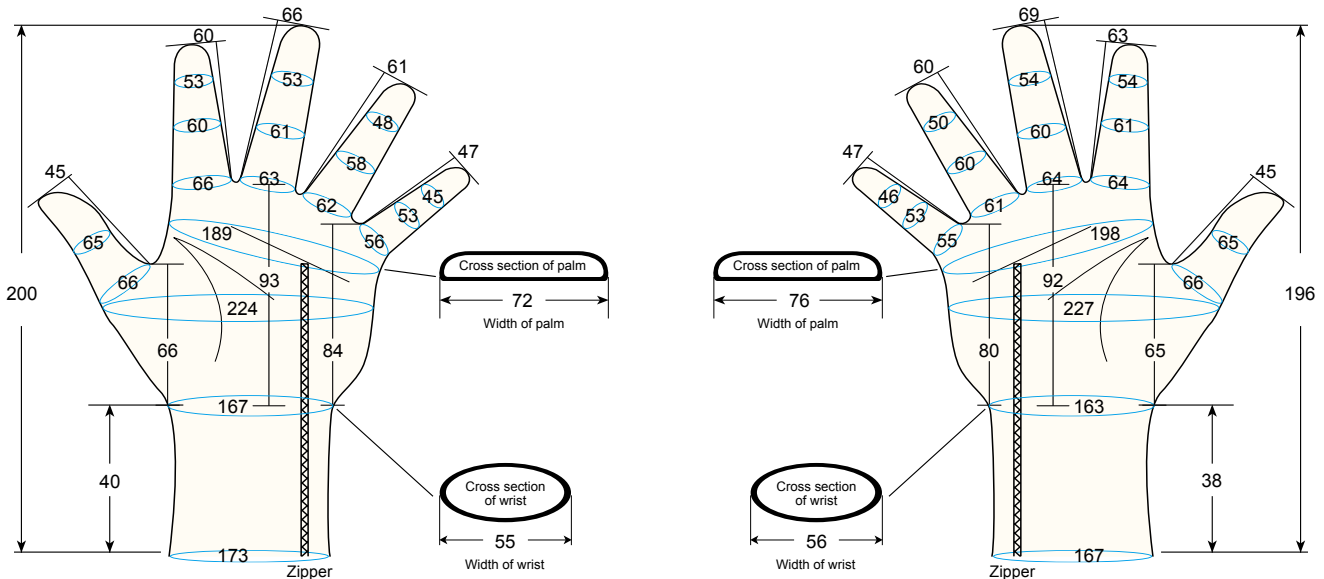

Model 101L, 102LS, 102L, 101LL, 102LSL, 102LL (pg:48)

Thickness: 2-2.5mm

(mm)

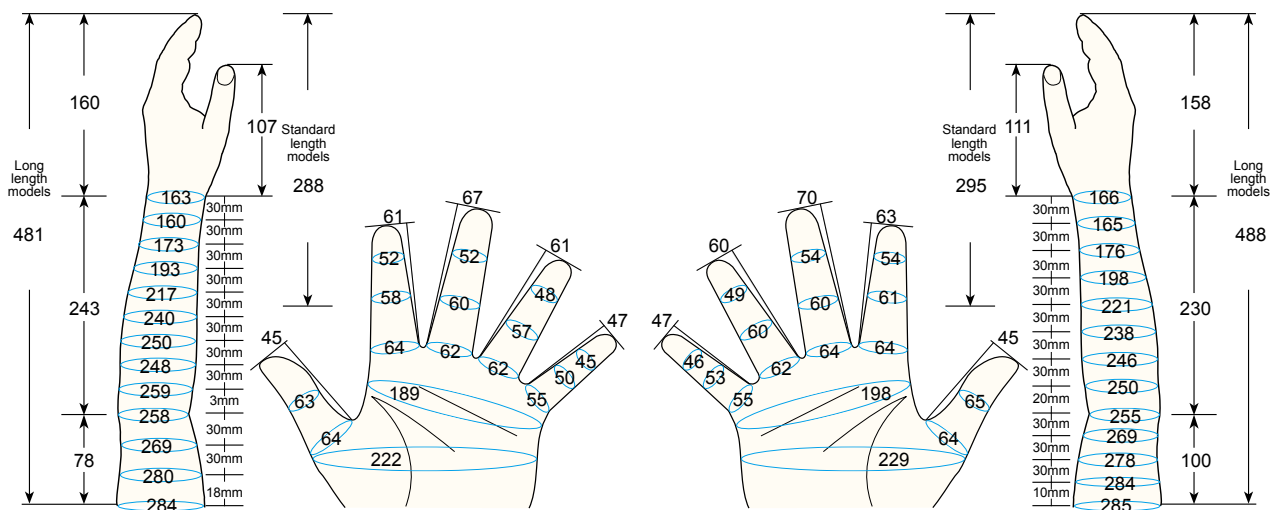

• All above information are for reference only •
• Please ask for more detail information •

Regal Silicone Prostheses

Product: Silicone prosthetic glove

Model: 101L, 102L, 102LS,
101LL, 102LL, 102LSL
103
200, Single finger

Size: Male, MS1
Female, LM1



✓ = Standard feature
O = Optional feature (no extra cost)
+ = Optional feature (extra cost)

Upgrade Option

Myo-Electric & Mechanical Gloves

Gloves, Passive & Partial Hands, Digits

Footcovers

Leg / Arm Sleeve Maxillofacial / Accessories

FAQ & Warranty

Product Structure (List of all available features of each Model and Size)

Product features description				Models					
Code				101L, 101LL	102L, 102LL	102LS, 102LSL	103	200 & Finger	
Basic Spec	Gender, Size (Code: M-MS1 / F-LM1)			✓	✓	✓	✓	✓	
	Side			L / R	✓	✓	✓	✓	
	Color - Single (use color sample from Regal)			✓	✓	✓	✓	✓	
Semi-Custom Made (p.7)			SCM	+	+	+	+	+	
Options: Aesthetics and Surface Enhancement	Color (p.14)	Dual Coloring Dorsal / Palmar (use color sample from Regal)		D/P	+	+	+	+	
		Custom Coloring (color sample is required)		CC	+	+	+	+	
	Nails, Hairs	X Series (p.16)		X	+	+	+	+	
		- Hair Dimension (available only when selecting X series)		2D / 3D	+	+	+	+	
		- Hair Color (available only when selecting X series) BB (Brown-Black), BR (Brown), BL (Black)		BB/BR /BL	+	+	+	+	
		Acrylic Nails (p.17)		ACRN	+	+	+	+	
	Smooth Coating	Smooth Coating (p.19)		SC	+	+	+	+	
Options: Structural Changes	Wrist Connector (p.20)	- External threaded stud, Metric		EX-MT		✓			
		- Internal, Metric		IN-MT		O			
		- External threaded stud, Imperial		EX-IP			O		
		- Internal, Imperial		IN-IP			O		
	Custom Filling (p.21)	- Foam		F		+		+	
		- Silicone		S		+		+	
		- Foam and Silicone (available depends on the length of the residual limb p.21)		F+S		+		+	
	Fingers Construction (p.23)	Wired Fingers	(with filling)	(available depends on the size of Silicone Prostheses & the length of residual limb p.23)	W		✓		
		Hinged Fingers			HF		+	+	+
		Reinforced Fingers * fingers with RF may be larger in circumference * not available when selecting SCM option			RF	+	+	+	
Fingers Bend (available only when selecting SCM) B1 (Straight), B2 (Standard), B3 (Extra Bend)			B1/B2 /B3				+		
Zipper	Zipper (p.25) (plastic)		PZ	+	+	+	✓		
Glue To Socket (p.25) (prosthetic socket is required)			GTS		+	+			

Regal Silicone Prostheses

Product: Silicone prosthetic glove

Model: 101L, 102L, 102LS,
101LL, 102LL, 102LSL
103
200, Single finger

Size: Male, S
Female, MS
Male, Child L



✓ = Standard feature
O = Optional feature (no extra cost)
+ = Optional feature (extra cost)

Product Structure (List of all available features of each Model and Size)

Product features description				Models				
Code				101L, 101LL	102L, 102LL	102LS, 102LSL	103	200 & Finger
Basic Spec	Gender, Size (Code: M-S / F-MS / M-CL)			✓	✓	✓	✓	✓
	Side			✓	✓	✓	✓	✓
	Color - Single (use color sample from Regal)			✓	✓	✓	✓	✓
Semi-Custom Made (p.7)			SCM	+	+	+	+	+
Options: Aesthetics and Surface Enhancement	Color (p.14)	Dual Coloring Dorsal / Palmar (use color sample from Regal)		D/P	+	+	+	+
		Custom Coloring (color sample is required)		CC	+	+	+	+
	Nails, Hairs	X Series (p.16)		X	+	+	+	+
		- Hair Dimension (available only when selecting X series)		2D / 3D	+	+	+	+
		- Hair Color (available only when selecting X series) BB (Brown-Black), BR (Brown), BL (Black)		BB/BR /BL	+	+	+	+
		Acrylic Nails (p.17)		ACRN	+	+	+	+
	Smooth Coating	Smooth Coating (p.19)		SC	+	+	+	+
Options: Structural Changes	Wrist Connector (p.20)	- External threaded stud, Metric		EX-MT			✓	
		- Internal, Metric		IN-MT			O	
		- External threaded stud, Imperial		EX-IP			O	
		- Internal, Imperial		IN-IP			O	
	Custom Filling (p.21)	- Foam		F		+		+
		- Silicone		S		+		+
		- Foam and Silicone		(available depends on the length of the residual limb p.21) F+S		+		+
	Fingers Construction (p.23)	Wired Fingers	(with filling)	(available depends on the size of Silicone Prostheses & the length of residual limb p.23) W		✓	✓	
		Hinged Fingers		HF		+	+	+
		Reinforced Fingers * fingers with RF may be larger in circumference * not available when selecting SCM option		RF	+	+	+	
Fingers Bend (available only when selecting SCM) B1 (Straight), B2 (Standard), B3 (Extra Bend)		B1/B2 /B3					+	
Zipper	Zipper (p.25) (plastic)		PZ	+	+	+	✓	
Glue To Socket (p.25) (prosthetic socket is required)		GTS		+	+			

How to order : See page 146

Please use the product codes from previous page.

Example:

102LSL - M - L - S	-	D3P2 - X - 2D - SC	-	HF - RF
--------------------	---	--------------------	---	---------

Basic specification

Options:
Aesthetics and Surface Enhancement

Options:
Structural Changes

How to measure : See page 147

Male, S / Female, MS / Male, Child L

Model 200 series and Single finger (pg:50)

Thickness: 1-1.8mm

(mm)

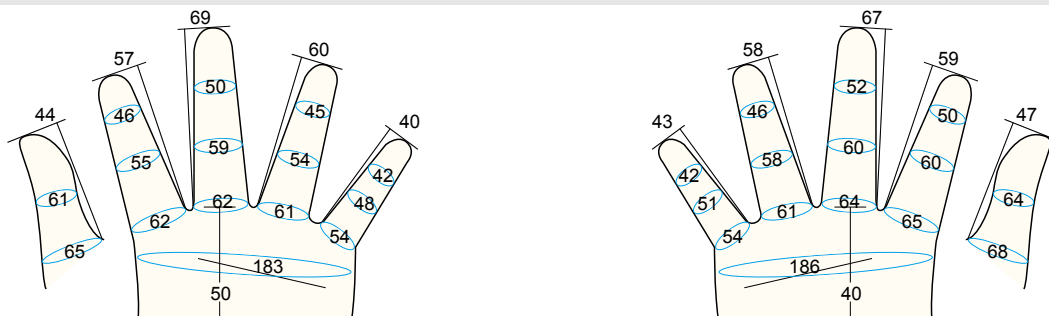

Model 103 (pg:49)

Thickness: 2-2.5mm

(mm)

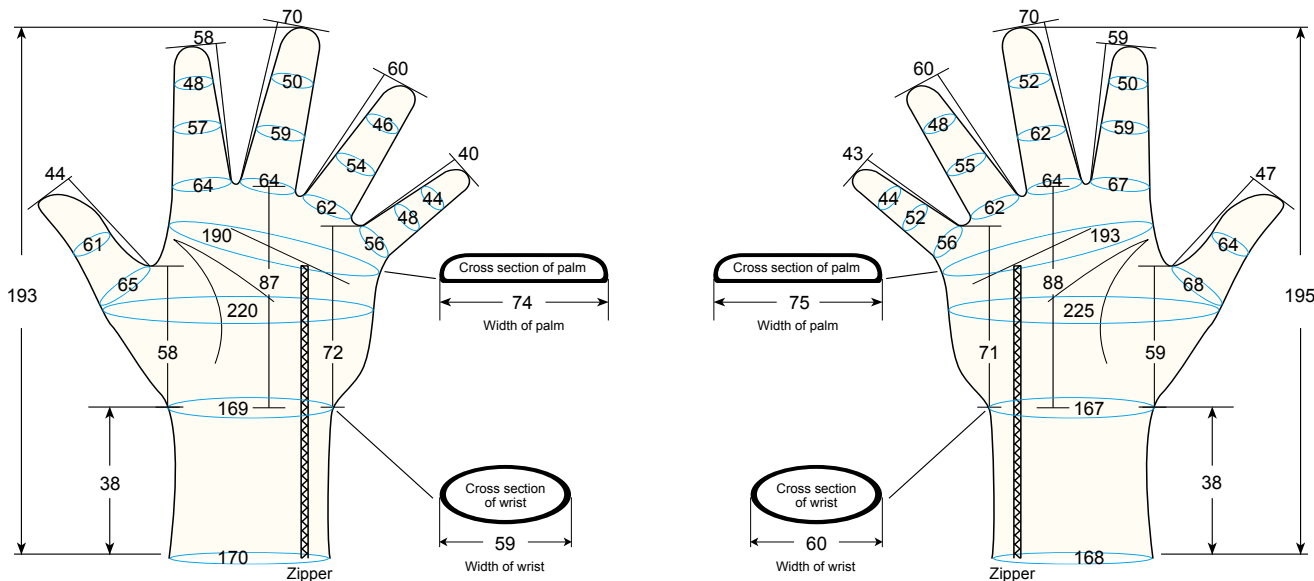

Model 101L, 102LS, 102L, 101LL, 102LSL, 102LL (pg:48)

Thickness: 2-2.5mm

(mm)

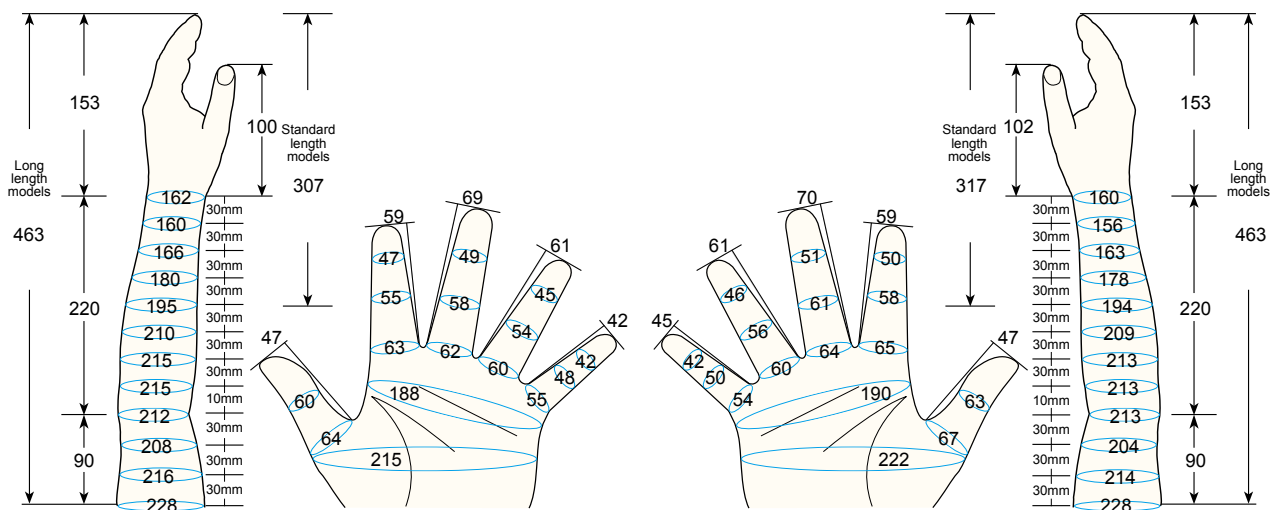

• All above information are for reference only •
• Please ask for more detail information •

Regal Silicone Prostheses

Product: Silicone prosthetic glove

Model: 101L, 102L, 102LS,
101LL, 102LL, 102LSL
103
200, Single finger

Size: Female, L



✓ = Standard feature
O = Optional feature (no extra cost)
+ = Optional feature (extra cost)

Product Structure (List of all available features of each Model and Size)

Product features description				Models				
Code				101L, 101LL	102L, 102LL	102LS, 102LSL	103	200 & Finger
Basic Spec	Gender, Size			F-L	✓	✓	✓	✓
	Side			L / R	✓	✓	✓	✓
	Color - Single (use color sample from Regal)				✓	✓	✓	✓
Semi-Custom Made (p.7)				SCM	+	+	+	+
Options: Aesthetics and Surface Enhancement	Color (p.14)	Dual Coloring Dorsal / Palmar (use color sample from Regal)		D/P	+	+	+	+
		Custom Coloring (color sample is required)		CC	+	+	+	+
	Nails, Hairs	X Series (p.16)		X	+	+	+	+
		- Hair Dimension (available only when selecting X series)		2D / 3D	+	+	+	+
		- Hair Color (available only when selecting X series) BB (Brown-Black), BR (Brown), BL (Black)		BB/BR /BL	+	+	+	+
		Acrylic Nails (p.17)		ACRN	+	+	+	+
	Smooth Coating	Smooth Coating (p.19)		SC	+	+	+	+
Options: Structural Changes	Wrist Connector (p.20)	- External threaded stud, Metric		EX-MT			✓	
		- Internal , Metric		IN-MT			O	
		- External threaded stud, Imperial		EX-IP				O
		- Internal, Imperial		IN-IP				O
	Custom Filling (p.21)	- Foam		F		+		+
		- Silicone		S		+		+
		- Foam and Silicone		(available depends on the length of the residual limb p.21) F+S		+		+
	Fingers Construction (p.23)	Wired Fingers	(with filling)	(available depends on the size of Silicone Prostheses & the length of residual limb p.23) W		✓	✓	
		Hinged Fingers		HF		+	+	+
		Reinforced Fingers * fingers with RF may be larger in circumference * not available when selecting SCM option		RF	+	+	+	
Fingers Bend (available only when selecting SCM) B1 (Straight), B2 (Standard) , B3 (Extra Bend)		B1/B2 /B3					+	
Zipper	Zipper (p.25) (plastic)		PZ	+	+	+	✓	
Glue To Socket (p.25) (prosthetic socket is required)		GTS		+	+			

How to order : See page 146

Please use the product codes from previous page.

Example:

102LSL - F - L - L	-	D3P2 - X - 2D - SC	-	HF - RF
Basic specification		Options: Aesthetics and Surface Enhancement		Options: Structural Changes

How to measure : See page 147

Female, L

Model 200 series and Single finger (pg:50)

Thickness: 1-1.8mm

(mm)

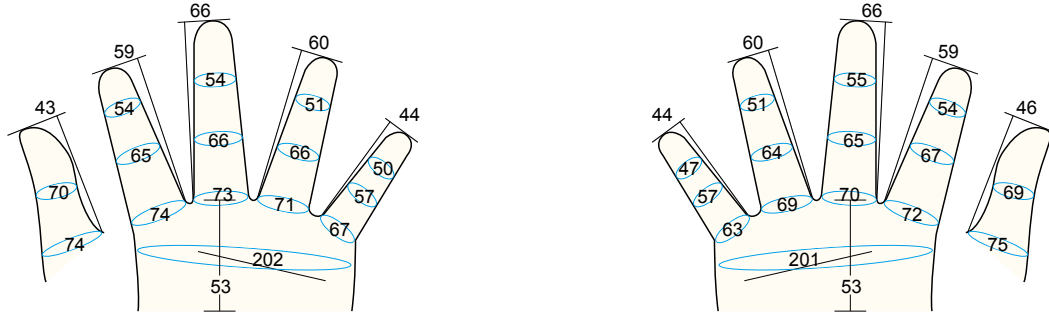

Model 103 (pg:49)

Thickness: 2-2.5mm

(mm)

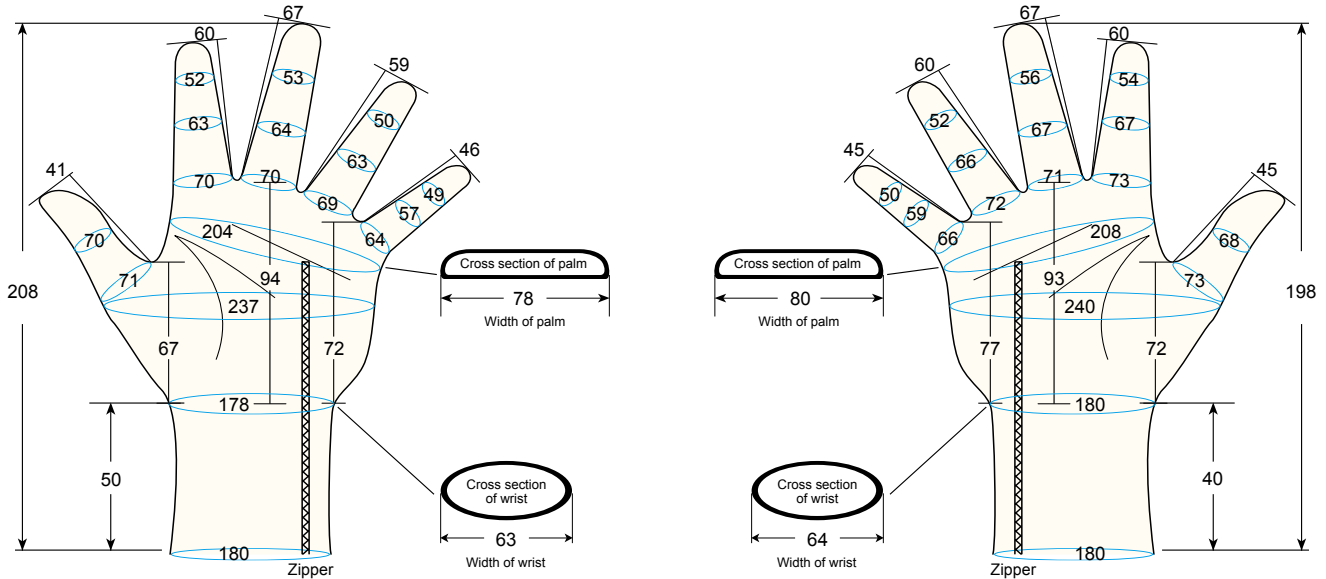

Model 101L, 102LS, 102L, 101LL, 102LSL, 102LL (pg:48)

Thickness: 2-2.5mm

(mm)

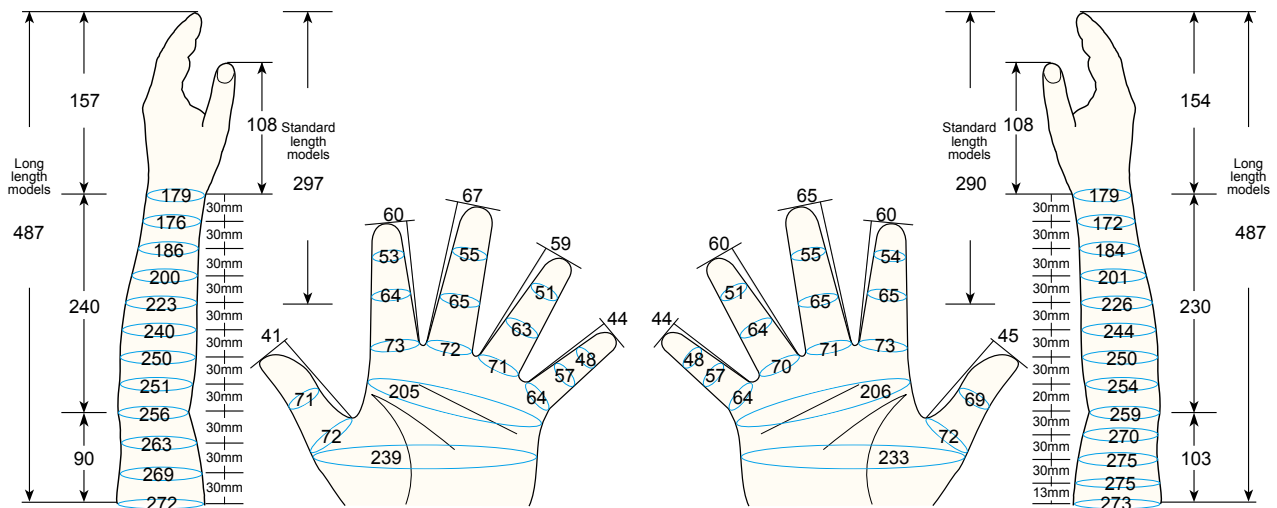

• All above information are for reference only •
• Please ask for more detail information •

Regal Silicone Prostheses

Product: Silicone prosthetic glove

Model: 101L, 102L, 102LS,
101LL, 102LL, 102LSL
103
200, Single finger

Size: Female, L2



✓ = Standard feature
O = Optional feature (no extra cost)
+ = Optional feature (extra cost)

Upgrade Option

Myo-Electric & Mechanical Gloves

Gloves, Passive & Partial Hands, Digits

Footcovers

Leg / Arm Sleeve Maxillofacial / Accessories

FAQ & Warranty

Product Structure (List of all available features of each Model and Size)

Product features description				Models				
Basic Spec	Code	101L, 101LL	102L, 102LL	102LS, 102LSL	103	200 & Finger		
Gender, Size	F-L2	✓	✓	✓	✓	✓	✓	
Side	L / R	✓	✓	✓	✓	✓	✓	
Color - Single (use color sample from Regal)		✓	✓	✓	✓	✓	✓	
Semi-Custom Made (p.7)	SCM	+	+	+	+	+	+	
Options: Aesthetics and Surface Enhancement	Color (p.14)							
	Dual Coloring Dorsal / Palmar (use color sample from Regal)	D/P	+	+	+	+	+	
	Custom Coloring (color sample is required)	CC	+	+	+	+	+	
	X Series (p.16)	X	+	+	+	+	+	
	Nails, Hairs							
	- Hair Dimension (available only when selecting X series)	2D / 3D	+	+	+	+	+	
- Hair Color (available only when selecting X series) BB (Brown-Black), BR (Brown), BL (Black)	BB/BR /BL	+	+	+	+	+		
Acrylic Nails (p.17)	ACRN	+	+	+	+	+		
Smooth Coating	Smooth Coating (p.19)	SC	+	+	+	+	+	
Options: Structural Changes	Wrist Connector (p.20)	- External threaded stud, Metric	EX-MT			✓		
		- Internal , Metric	IN-MT			O		
		- External threaded stud, Imperial	EX-IP			O		
		- Internal, Imperial	IN-IP			O		
	Custom Filling (p.21)	- Foam	F		+		+	+
		- Silicone	S		+		+	+
		- Foam and Silicone	F+S		+		+	+
	Fingers Construction (p.23)	Wired Fingers	W		✓	✓		
		Hinged Fingers	HF		+	+	+	+
		Reinforced Fingers * fingers with RF may be larger in circumference * not available when selecting SCM option	RF	+	+	+		
Fingers Bend (available only when selecting SCM) B1 (Straight), B2 (Standard) , B3 (Extra Bend)		B1/B2 /B3					+	
Zipper	Zipper (p.25) (plastic)	PZ	+	+	+	✓		
	Glue To Socket (p.25) (prosthetic socket is required)	GTS		+	+			

How to order : See page 146

Please use the product codes from previous page.

Example:

102LSL - F - L - L2	-	D3P2 - X - 2D - SC	-	HF - RF
Basic specification		Options: Aesthetics and Surface Enhancement		Options: Structural Changes

How to measure : See page 147

Model 200 series and Single finger (pg:50)

Thickness: 1-1.8mm

(mm)

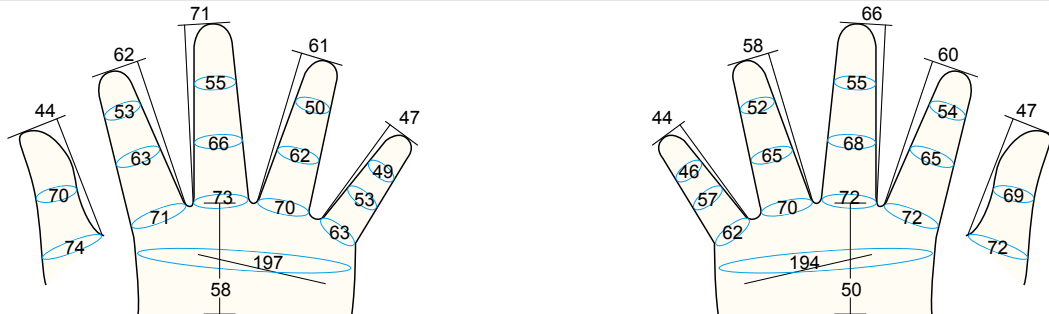

Model 103 (pg:49)

Thickness: 2-2.5mm

(mm)

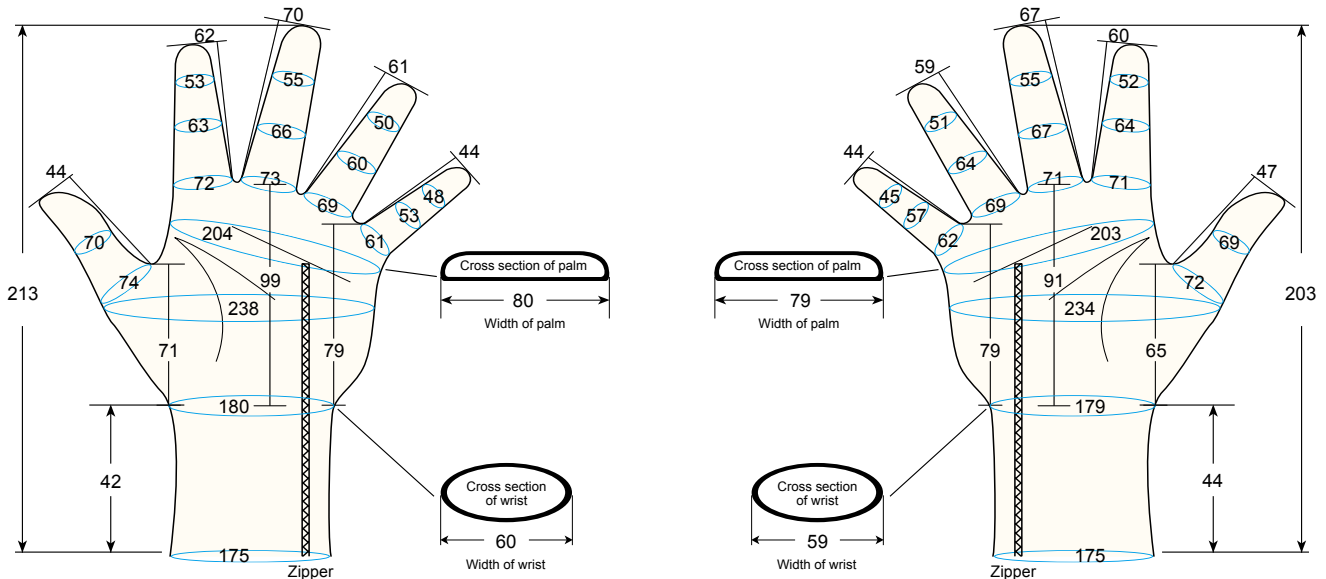

Model 101L, 102LS, 102L, 101LL, 102LSL, 102LL (pg:48)

Thickness: 2-2.5mm

(mm)

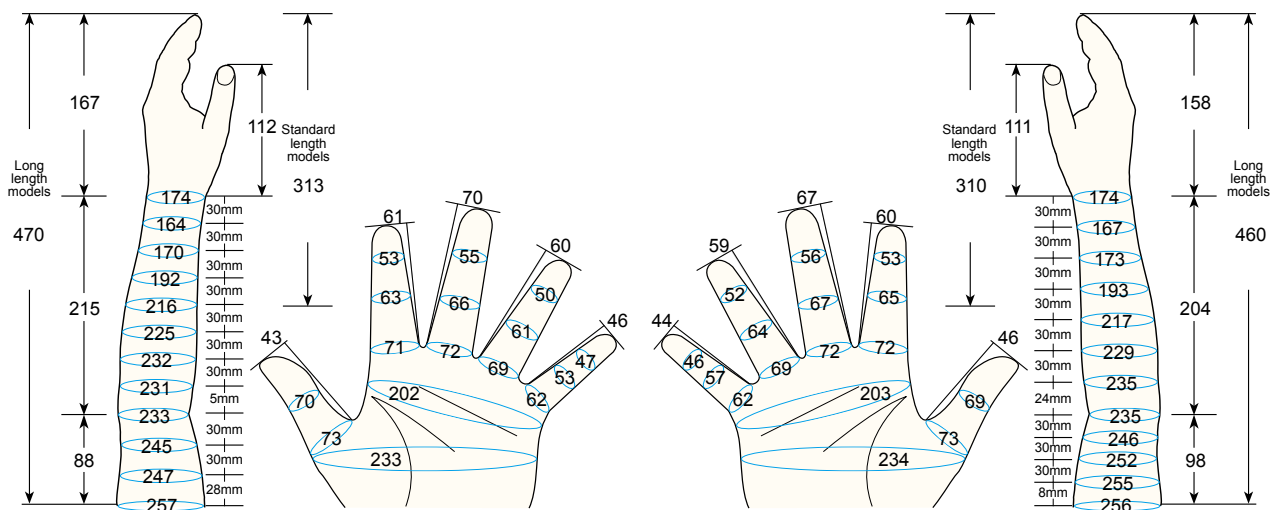

• All above information are for reference only •
• Please ask for more detail information •

Regal Silicone Prostheses

Product: Silicone prosthetic glove

Model: 101L, 102L, 102LS,
101LL, 102LL, 102LSL
103
200, Single finger

Size: Female, M



✓ = Standard feature
O = Optional feature (no extra cost)
+ = Optional feature (extra cost)

Product Structure (List of all available features of each Model and Size)

Product features description				Models				
Code				101L, 101LL	102L, 102LL	102LS, 102LSL	103	200 & Finger
Basic Spec	Gender, Size			F-M	✓	✓	✓	✓
	Side			L / R	✓	✓	✓	✓
	Color - Single (use color sample from Regal)				✓	✓	✓	✓
Semi-Custom Made (p.7)				SCM	+	+	+	+
Options: Aesthetics and Surface Enhancement	Color (p.14)	Dual Coloring Dorsal / Palmar (use color sample from Regal)		D/P	+	+	+	+
		Custom Coloring (color sample is required)		CC	+	+	+	+
	Nails, Hairs	X Series (p.16)		X	+	+	+	+
		- Hair Dimension (available only when selecting X series)		2D / 3D	+	+	+	+
		- Hair Color (available only when selecting X series) BB (Brown-Black), BR (Brown), BL (Black)		BB/BR /BL	+	+	+	+
		Acrylic Nails (p.17)		ACRN	+	+	+	+
	Smooth Coating	Smooth Coating (p.19)		SC	+	+	+	+
Options: Structural Changes	Wrist Connector (p.20)	- External threaded stud, Metric		EX-MT			✓	
		- Internal , Metric		IN-MT			O	
		- External threaded stud, Imperial		EX-IP			O	
		- Internal, Imperial		IN-IP			O	
	Custom Filling (p.21)	- Foam		F		+		+
		- Silicone		S		+		+
		- Foam and Silicone		(available depends on the length of the residual limb p.21) F+S		+		+
	Fingers Construction (p.23)	Wired Fingers	(with filling)	(available depends on the size of Silicone Prostheses & the length of residual limb p.23) W		✓	✓	
		Hinged Fingers		HF		+	+	+
		Reinforced Fingers * fingers with RF may be larger in circumference * not available when selecting SCM option		RF	+	+	+	
Fingers Bend (available only when selecting SCM) B1 (Straight), B2 (Standard) , B3 (Extra Bend)		B1/B2 /B3					+	
Zipper	Zipper (p.25) (plastic)		PZ	+	+	+	✓	
Glue To Socket (p.25) (prosthetic socket is required)		GTS		+	+			

How to order : See page 146

Please use the product codes from previous page.

Example:

102LSL - F - L - M	-	D3P2 - X - 2D - SC	-	HF - RF
Basic specification		Options: Aesthetics and Surface Enhancement		Options: Structural Changes

How to measure : See page 147

Female, M

Model 200 series and Single finger (pg:50)

Thickness: 1-1.8mm

(mm)

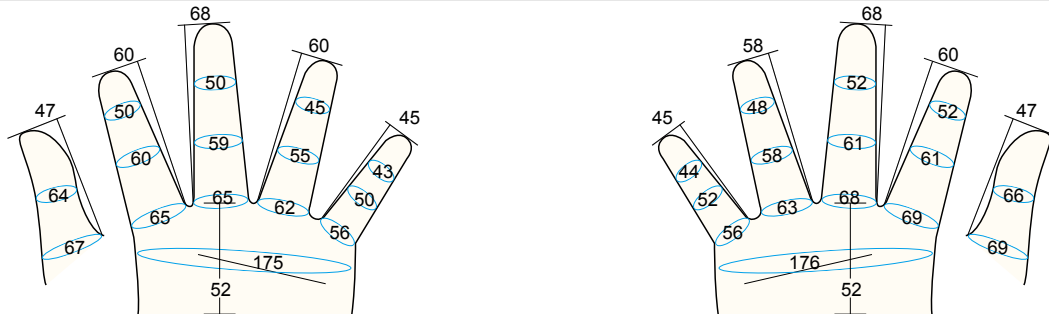

Model 103 (pg:49)

Thickness: 2-2.5mm

(mm)

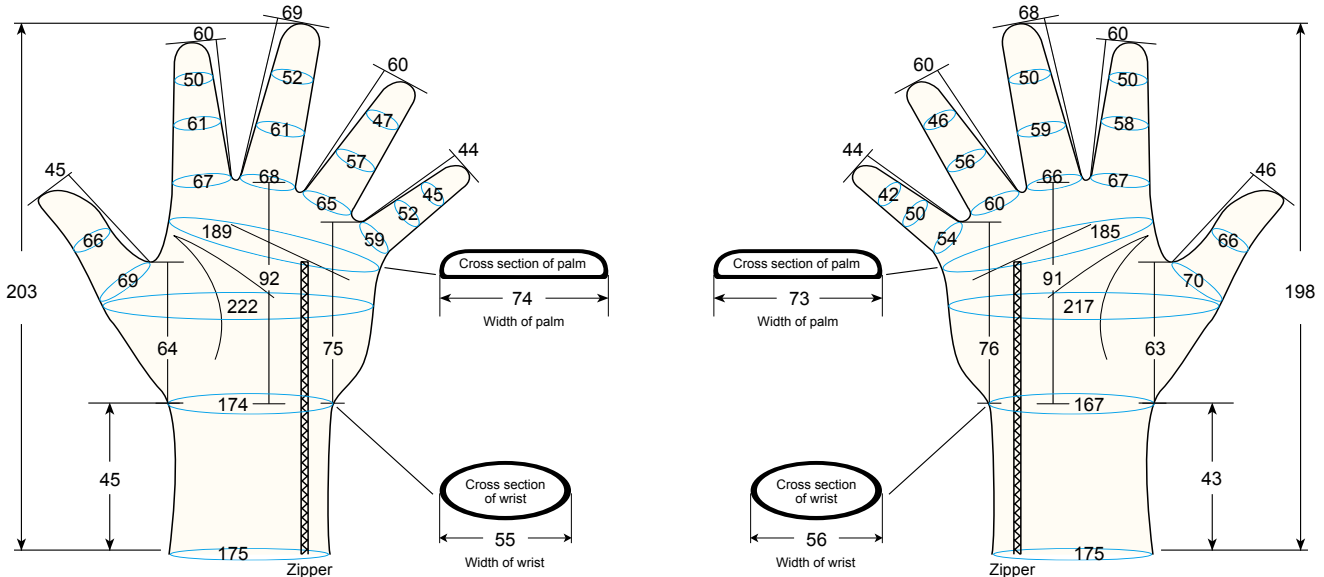

Model 101L, 102LS, 102L, 101LL, 102LSL, 102LL (pg:48)

Thickness: 2-2.5mm

(mm)

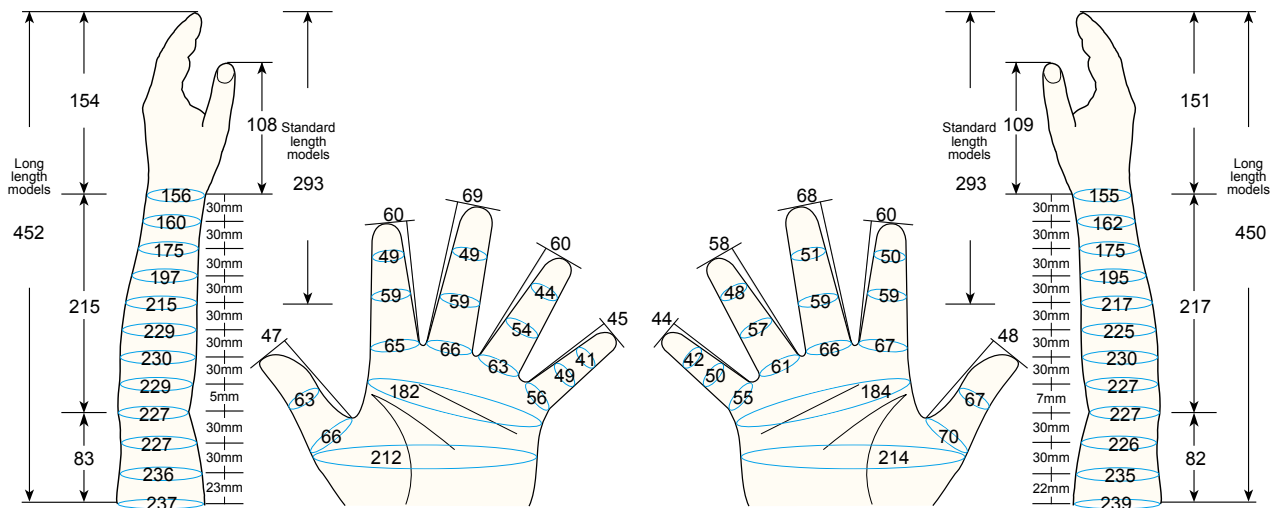

• All above information are for reference only •
• Please ask for more detail information •

Regal Silicone Prostheses

Product: Silicone prosthetic glove

Model: 101L, 102L, 102LS,
101LL, 102LL, 102LSL
103
200, Single finger

Size: Female, S



✓ = Standard feature
O = Optional feature (no extra cost)
+ = Optional feature (extra cost)

Product Structure (List of all available features of each Model and Size)

Product features description				Models					
Code				101L, 101LL	102L, 102LL	102LS, 102LSL	103	200 & Finger	
Basic Spec	Gender, Size		F-S	✓	✓	✓	✓	✓	
	Side		L / R	✓	✓	✓	✓	✓	
	Color - Single (use color sample from Regal)			✓	✓	✓	✓	✓	
Semi-Custom Made (p.7)			SCM	+	+	+	+	+	
Options: Aesthetics and Surface Enhancement	Color (p.14)	Dual Coloring Dorsal / Palmar (use color sample from Regal)		D/P	+	+	+	+	
		Custom Coloring (color sample is required)		CC	+	+	+	+	
	Nails, Hairs	X Series (p.16)		X	+	+	+	+	
		- Hair Dimension (available only when selecting X series)		2D / 3D	+	+	+	+	+
		- Hair Color (available only when selecting X series) BB (Brown-Black), BR (Brown), BL (Black)		BB/BR /BL	+	+	+	+	+
		Acrylic Nails (p.17)		ACRN	+	+	+	+	+
	Smooth Coating	Smooth Coating (p.19)		SC	+	+	+	+	
Options: Structural Changes	Wrist Connector (p.20)	- External threaded stud, Metric		EX-MT			✓		
		- Internal , Metric		IN-MT			O		
		- External threaded stud, Imperial		EX-IP			O		
		- Internal, Imperial		IN-IP			O		
	Custom Filling (p.21)	- Foam		F		+		+	
		- Silicone		S		+		+	
		- Foam and Silicone		(available depends on the length of the residual limb p.21) F+S		+		+	
	Fingers Construction (p.23)	Wired Fingers	(with filling)	(available depends on the size of Silicone Prostheses & the length of residual limb p.23) W		✓	✓		
		Hinged Fingers		HF		+	+	+	
		Reinforced Fingers * fingers with RF may be larger in circumference * not available when selecting SCM option		RF	+	+	+		
Fingers Bend (available only when selecting SCM) B1 (Straight), B2 (Standard) , B3 (Extra Bend)		B1/B2 /B3					+		
Zipper	Zipper (p.25) (plastic)		PZ	+	+	+	✓		
	Glue To Socket (p.25) (prosthetic socket is required)		GTS		+	+			

How to order : See page 146

Please use the product codes from previous page.

Example:

102LSL - F - L - S	-	D3P2 - X - 2D - SC	-	HF - RF
Basic specification		Options: Aesthetics and Surface Enhancement		Options: Structural Changes

How to measure : See page 147

Female, S

Model 200 series and Single finger (pg:50) Thickness: 1-1.8mm (mm)

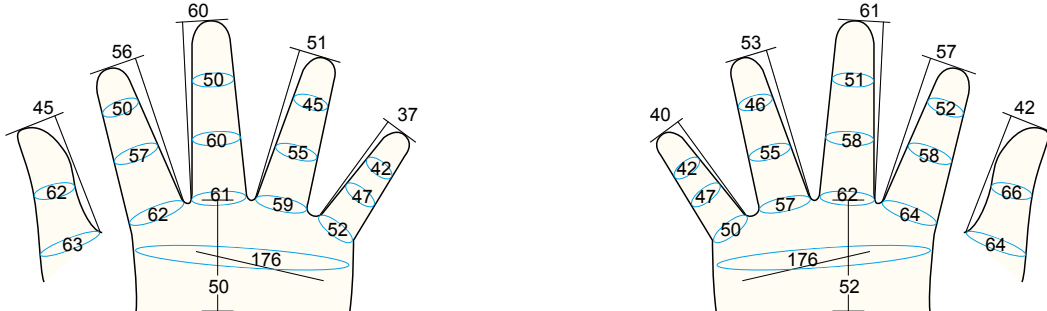

Model 103 (pg:49) Thickness: 2-2.5mm (mm)

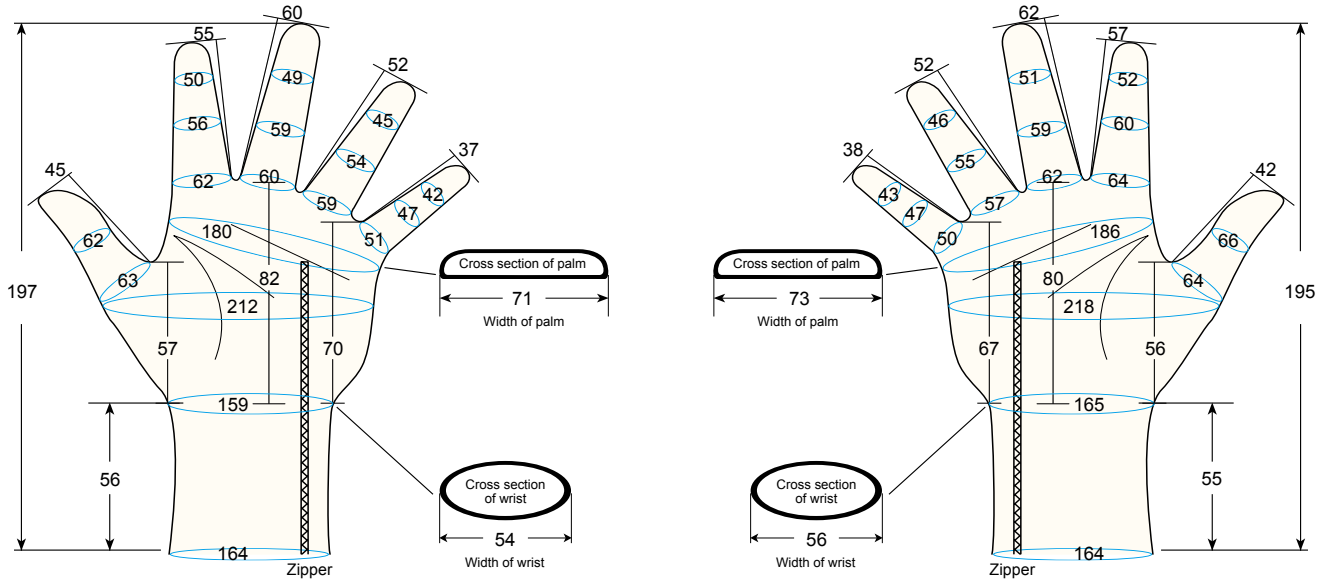

Model 101L, 102LS, 102L, 101LL, 102LSL, 102LL (pg:48) Thickness: 2-2.5mm (mm)

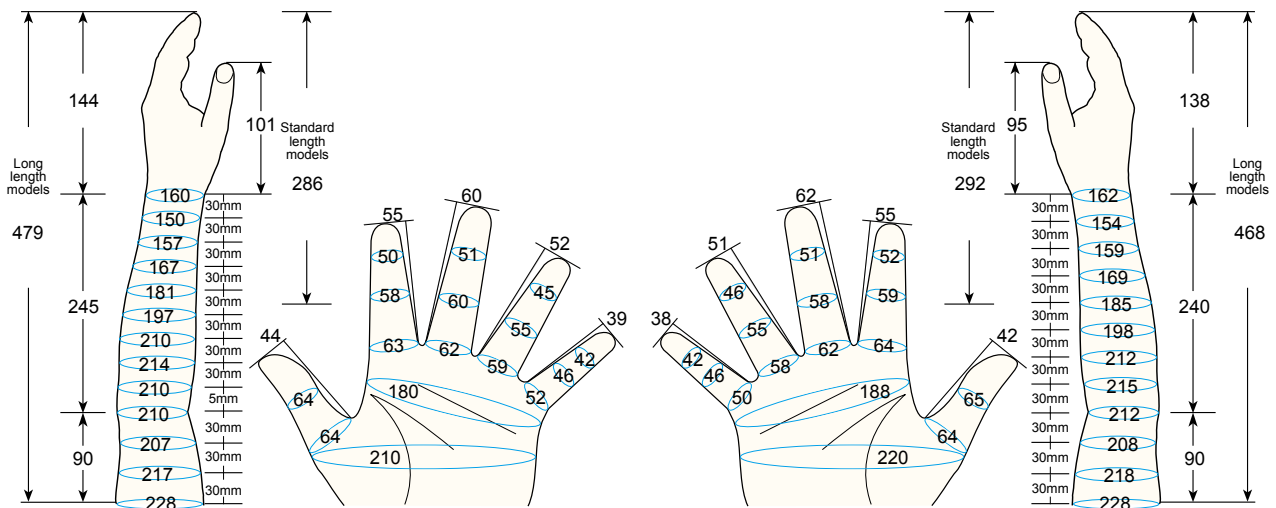

• All above information are for reference only •
• Please ask for more detail information •

Regal Silicone Prostheses

Product: Silicone prosthetic glove

Model: 101L, 102L, 102LS,
101LL, 102LL, 102LSL
103
200, Single finger

Size: Male, Child L1
Female, MS2



✓ = Standard feature
O = Optional feature (no extra cost)
+ = Optional feature (extra cost)

Product Structure (List of all available features of each Model and Size)

Product features description				Models				
Code				101L, 101LL	102L, 102LL	102LS, 102LSL	103	200 & Finger
Basic Spec	Gender, Size (Code: M-CL1 / F-MS2)			✓	✓	✓	✓	✓
	Side			L / R	✓	✓	✓	✓
	Color - Single (use color sample from Regal)			✓	✓	✓	✓	✓
Semi-Custom Made (p.7)			SCM	+	+	+	+	+
Options: Aesthetics and Surface Enhancement	Color (p.14)	Dual Coloring Dorsal / Palmar (use color sample from Regal)		D/P	+	+	+	+
		Custom Coloring (color sample is required)		CC	+	+	+	+
	Nails, Hairs	X Series (p.16)		X	+	+	+	+
		- Hair Dimension (available only when selecting X series)		2D / 3D	+	+	+	+
		- Hair Color (available only when selecting X series) BB (Brown-Black), BR (Brown), BL (Black)		BB/BR /BL	+	+	+	+
		Acrylic Nails (p.17)		ACRN	+	+	+	+
	Smooth Coating	Smooth Coating (p.19)		SC	+	+	+	+
Options: Structural Changes	Wrist Connector (p.20)	- External threaded stud, Metric		EX-MT			✓	
		- Internal , Metric		IN-MT			O	
		- External threaded stud, Imperial		EX-IP			O	
		- Internal, Imperial		IN-IP			O	
	Custom Filling (p.21)	- Foam		F		+		+
		- Silicone		S		+		+
		- Foam and Silicone		(available depends on the length of the residual limb p.21) F+S		+		+
	Fingers Construction (p.23)	Wired Fingers	(with filling)	(available depends on the size of Silicone Prostheses & the length of residual limb p.23) W		✓	✓	
		Hinged Fingers		HF		+	+	+
		Reinforced Fingers * fingers with RF may be larger in circumference * not available when selecting SCM option		RF	+	+	+	
Fingers Bend (available only when selecting SCM) B1 (Straight), B2 (Standard) , B3 (Extra Bend)		B1/B2 /B3					+	
Zipper	Zipper (p.25) (plastic)		PZ	+	+	+	✓	
Glue To Socket (p.25) (prosthetic socket is required)		GTS		+	+			

How to order : See page 146

Please use the product codes from previous page.

Example:

102LSL - M - L - CL1	-	D3P2 - X - 2D - SC	-	HF - RF
----------------------	---	--------------------	---	---------

Basic specification

Options:
Aesthetics and Surface Enhancement

Options:
Structural Changes

How to measure : See page 147

Male, Child L1 / Female, MS2

Model 200 series and Single finger (pg:50)

Thickness: 1-1.8mm

(mm)

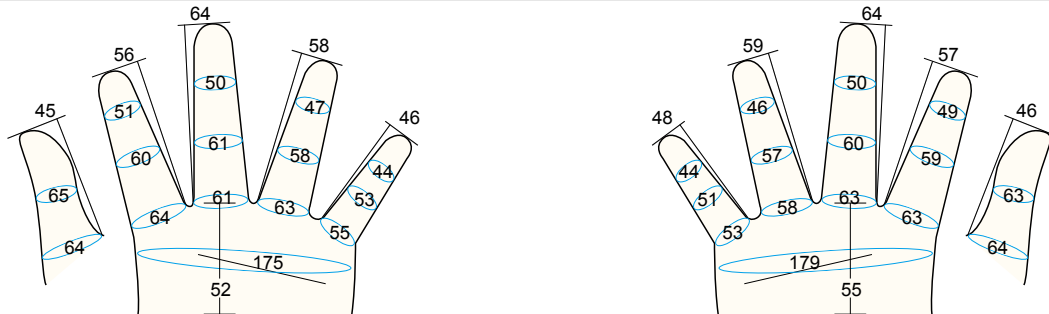

Model 103 (pg:49)

Thickness: 2-2.5mm

(mm)

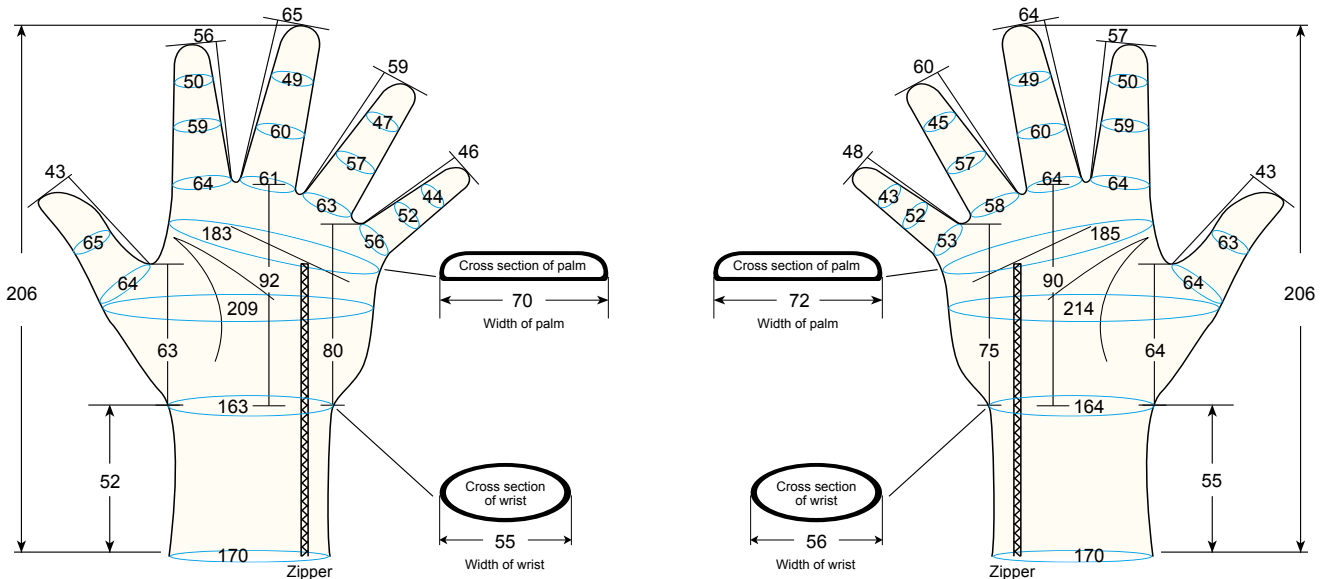

Model 101L, 102LS, 102L, 101LL, 102LSL, 102LL (pg:48)

Thickness: 2-2.5mm

(mm)

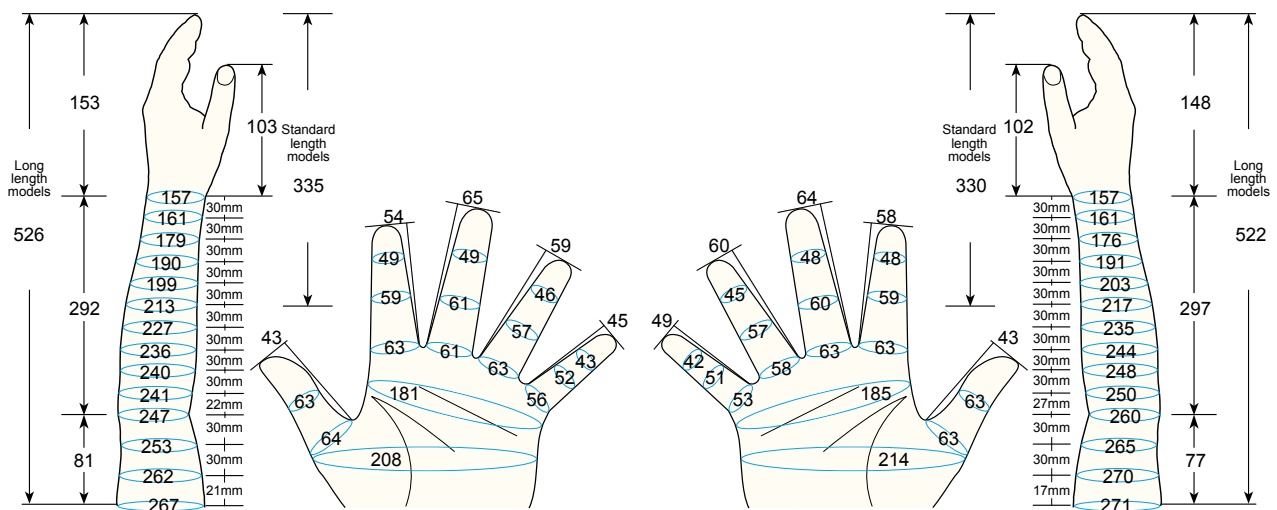

• All above information are for reference only •
• Please ask for more detail information •

Regal Silicone Prostheses

Product: Silicone prosthetic glove

Model: 101L, 102L, 102LS,
101LL, 102LL, 102LSL
103
200, Single finger

Size: Female, S1
Male, Child M
Female, Child L



✓ = Standard feature
O = Optional feature (no extra cost)
+ = Optional feature (extra cost)

Product Structure (List of all available features of each Model and Size)

Product features description				Models					
Code				101L, 101LL	102L, 102LL	102LS, 102LSL	103	200 & Finger	
Basic Spec	Gender, Size (Code: F-S1 / M-CM / F-CL)			✓	✓	✓	✓	✓	
	Side			L / R	✓	✓	✓	✓	
	Color - Single (use color sample from Regal)			✓	✓	✓	✓	✓	
Semi-Custom Made (p.7)			SCM	+	+	+	+	+	
Options: Aesthetics and Surface Enhancement	Color (p.14)	Dual Coloring Dorsal / Palmar (use color sample from Regal)		D/P	+	+	+	+	
		Custom Coloring (color sample is required)		CC	+	+	+	+	
	Nails, Hairs	X Series (p.16)		X	+	+	+	+	
		- Hair Dimension (available only when selecting X series)		2D / 3D	+	+	+	+	
		- Hair Color (available only when selecting X series) BB (Brown-Black), BR (Brown), BL (Black)		BB/BR /BL	+	+	+	+	
		Acrylic Nails (p.17)		ACRN					
	Smooth Coating	Smooth Coating (p.19)		SC	+	+	+	+	
Options: Structural Changes	Wrist Connector (p.20)	- External threaded stud, Metric		EX-MT			✓		
		- Internal, Metric		IN-MT			O		
		- External threaded stud, Imperial		EX-IP				O	
		- Internal, Imperial		IN-IP				O	
	Custom Filling (p.21)	- Foam		F		+		+	
		- Silicone		S		+		+	
		- Foam and Silicone (available depends on the length of the residual limb p.21)		F+S		+		+	
	Fingers Construction (p.23)	Wired Fingers	(with filling)	(available depends on the size of Silicone Prostheses & the length of residual limb p.23)	W		✓		
		Hinged Fingers			HF		+		+
		Reinforced Fingers * fingers with RF may be larger in circumference * not available when selecting SCM option			RF				
Fingers Bend (available only when selecting SCM) B1 (Straight), B2 (Standard), B3 (Extra Bend)			B1/B2 /B3				+		
Zipper	Zipper (p.25) (plastic)		PZ	+	+	+	✓		
Glue To Socket (p.25) (prosthetic socket is required)			GTS		+	+			

How to order : See page 146

Please use the product codes from previous page.

Example:

102LSL - M - L - CM	-	D3P2 - X - 2D - SC	-	HF - RF
---------------------	---	--------------------	---	---------

Basic specification

Options:
Aesthetics and Surface Enhancement

Options:
Structural Changes

How to measure : See page 147

Female, S1 / Male, Child M / Female, Child L

Model 200 series and Single finger (pg:50)

Thickness: 1-1.8mm

(mm)

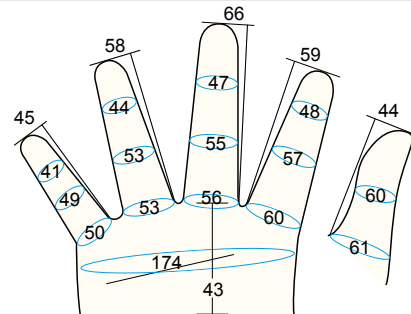
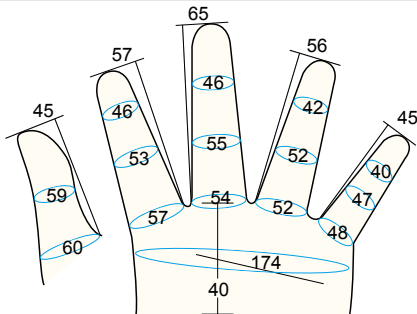

Model 103 (pg:49)

Thickness: 2-2.5mm

(mm)

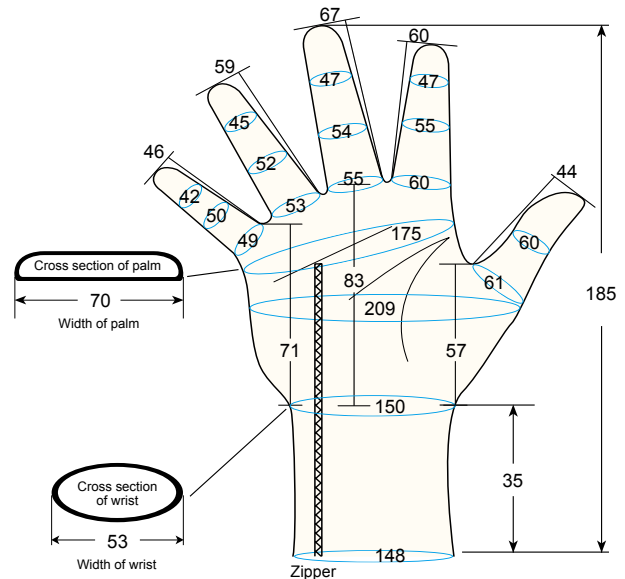
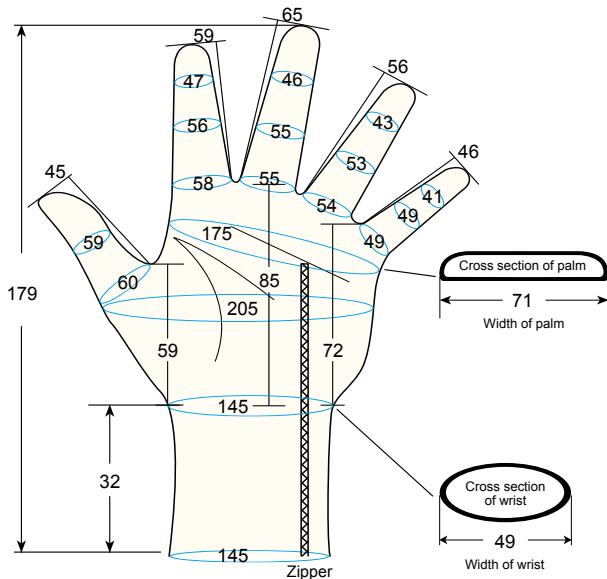

Model 101L, 102LS, 102L, 101LL, 102LSL, 102LL (pg:48)

Thickness: 2-2.5mm

(mm)

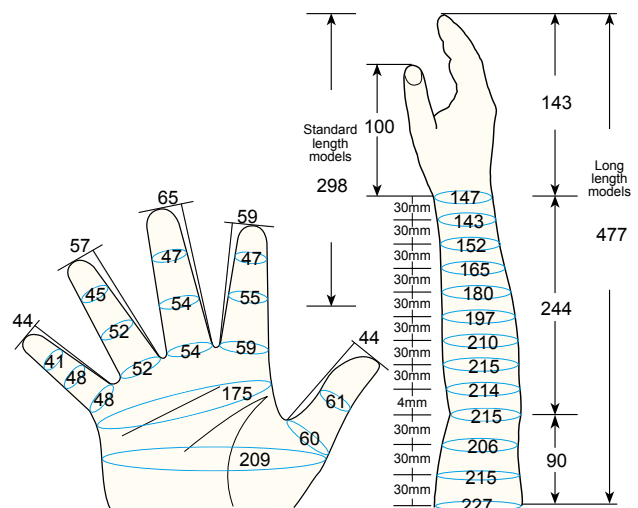
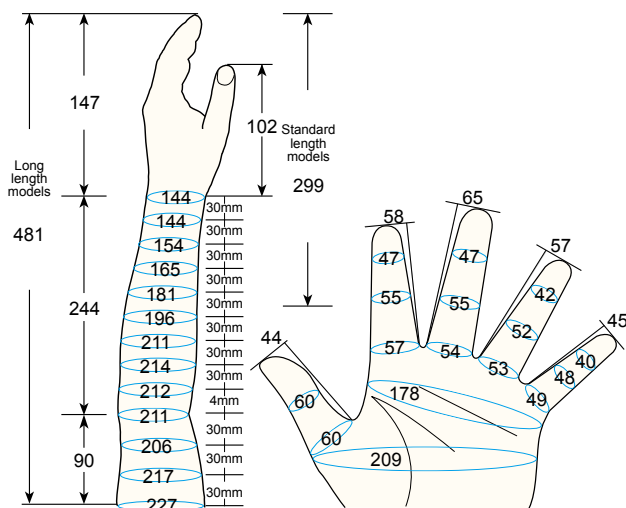

• All above information are for reference only •
• Please ask for more detail information •

Regal Silicone Prostheses

Product: Silicone prosthetic glove

Model: 101L, 102L, 102LS,
101LL, 102LL, 102LSL
103
200, Single finger

Size: Female, Child M



✓ = Standard feature
O = Optional feature (no extra cost)
+ = Optional feature (extra cost)

Product Structure (List of all available features of each Model and Size)

Product features description				Models				
Code				101L, 101LL	102L, 102LL	102LS, 102LSL	103	200 & Finger
Basic Spec	Gender, Size		F-CM	✓	✓	✓	✓	✓
	Side		L / R	✓	✓	✓	✓	✓
	Color - Single (use color sample from Regal)			✓	✓	✓	✓	✓
Semi-Custom Made (p.7)			SCM	+	+	+	+	+
Options: Aesthetics and Surface Enhancement	Color (p.14)	Dual Coloring Dorsal / Palmar (use color sample from Regal)		D/P	+	+	+	+
		Custom Coloring (color sample is required)		CC	+	+	+	+
	Nails, Hairs	X Series (p.16)		X	+	+	+	+
		- Hair Dimension (available only when selecting X series)		2D / 3D	+	+	+	+
		- Hair Color (available only when selecting X series) BB (Brown-Black), BR (Brown), BL (Black)		BB/BR /BL	+	+	+	+
		Acrylic Nails (p.17)		ACRN	+	+	+	+
	Smooth Coating	Smooth Coating (p.19)		SC	+	+	+	+
Options: Structural Changes	Wrist Connector (p.20)	- External threaded stud, Metric		EX-MT			✓	
		- Internal , Metric		IN-MT			O	
		- External threaded stud, Imperial		EX-IP			O	
		- Internal, Imperial		IN-IP			O	
	Custom Filling (p.21)	- Foam		F		+		+
		- Silicone		S		+		+
		- Foam and Silicone		F+S		+		+
	Fingers Construction (p.23)	Wired Fingers	(with filling)	(available depends on the length of the residual limb p.21)	W		✓	
		Hinged Fingers		(available depends on the size of Silicone Prostheses & the length of residual limb p.23)	HF		+	+
		Reinforced Fingers * fingers with RF may be larger in circumference * not available when selecting SCM option			RF			
Fingers Bend (available only when selecting SCM) B1 (Straight), B2 (Standard) , B3 (Extra Bend)			B1/B2 /B3				+	
Zipper	Zipper (p.25) (plastic)		PZ	+	+	+	✓	
	Glue To Socket (p.25) (prosthetic socket is required)		GTS		+	+		

How to order : See page 146

Please use the product codes from previous page.

Example:

102LSL - F - L - CM	-	D3P2 - X - 2D - SC	-	HF - RF
---------------------	---	--------------------	---	---------

Basic specification

Options:
Aesthetics and Surface Enhancement

Options:
Structural Changes

How to measure : See page 147

Female, Child M

Model 200 series and Single finger (pg:50)

Thickness: 1-1.8mm

(mm)

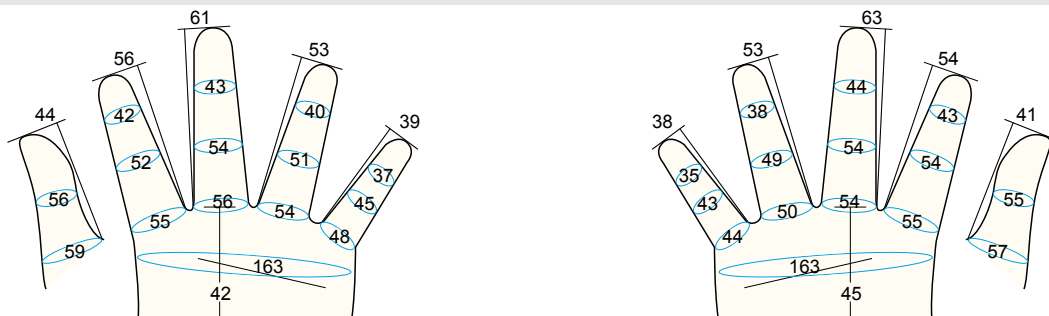

Model 103 (pg:49)

Thickness: 2-2.5mm

(mm)

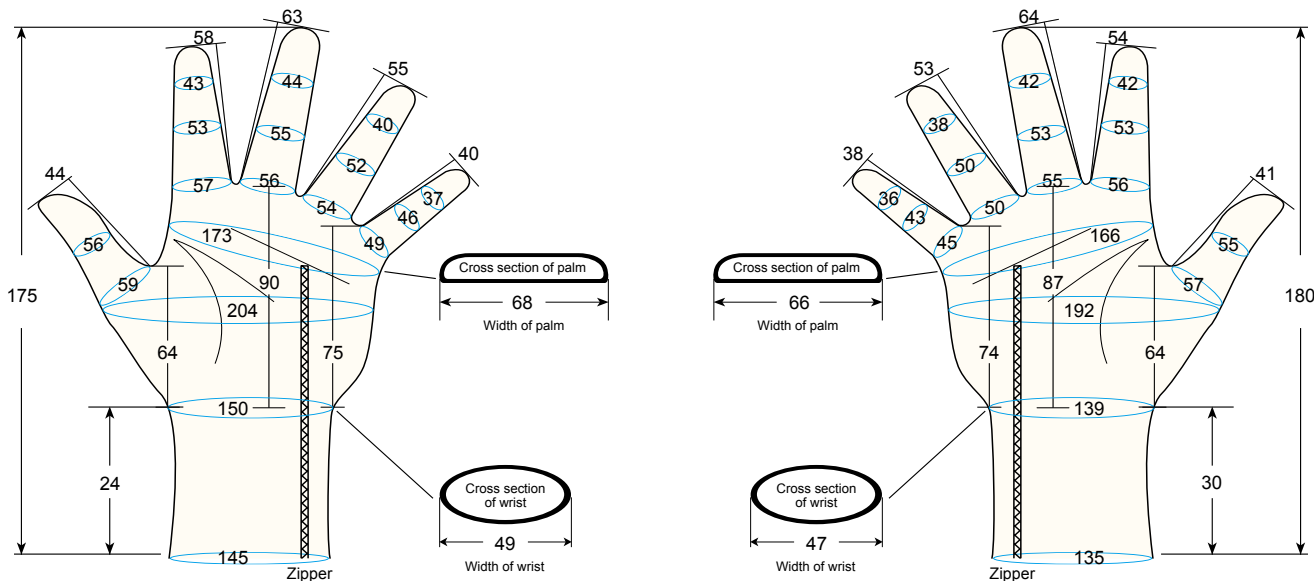

Model 101L, 102LS, 102L, 101LL, 102LSL, 102LL (pg:48)

Thickness: 2-2.5mm

(mm)

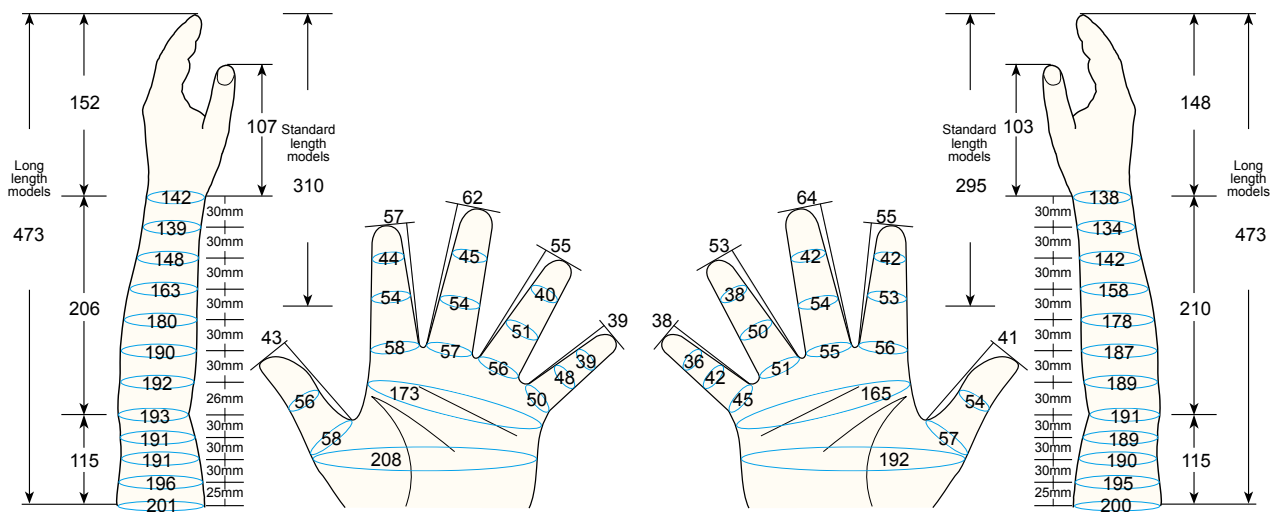

• All above information are for reference only •
• Please ask for more detail information •

Regal Silicone Prostheses

Product: Silicone prosthetic glove

Model: 101L, 102L, 102LS,
101LL, 102LL, 102LSL
103
200, Single finger

Size: Female, Child M1



- ✓ = Standard feature
- O = Optional feature (no extra cost)
- + = Optional feature (extra cost)

Product Structure (List of all available features of each Model and Size)

Product features description				Models				
Code				101L, 101LL	102L, 102LL	102LS, 102LSL	103	200 & Finger
Basic Spec	Gender, Size		F-CM1	✓	✓	✓	✓	✓
	Side		L / R	✓	✓	✓	✓	✓
	Color - Single (use color sample from Regal)			✓	✓	✓	✓	✓
Semi-Custom Made (p.7)			SCM	+	+	+	+	+
Options: Aesthetics and Surface Enhancement	Color (p.14)	Dual Coloring Dorsal / Palmar (use color sample from Regal)		D/P	+	+	+	+
		Custom Coloring (color sample is required)		CC	+	+	+	+
	Nails, Hairs	X Series (p.16)		X	+	+	+	+
		- Hair Dimension (available only when selecting X series)		2D / 3D	+	+	+	+
		- Hair Color (available only when selecting X series) BB (Brown-Black), BR (Brown), BL (Black)		BB/BR /BL	+	+	+	+
		Acrylic Nails (p.17)		ACRN	+	+	+	+
	Smooth Coating	Smooth Coating (p.19)		SC	+	+	+	+
Options: Structural Changes	Wrist Connector (p.20)	- External threaded stud, Metric		EX-MT			✓	
		- Internal , Metric		IN-MT			O	
		- External threaded stud, Imperial		EX-IP			O	
		- Internal, Imperial		IN-IP			O	
	Custom Filling (p.21)	- Foam		F		+		+
		- Silicone		S		+		+
		- Foam and Silicone		F+S		+		+
	Fingers Construction (p.23)	Wired Fingers	(with filling)	(available depends on the length of the residual limb p.21)	W		✓	
		Hinged Fingers		(available depends on the size of Silicone Prostheses & the length of residual limb p.23)	HF		+	+
		Reinforced Fingers * fingers with RF may be larger in circumference * not available when selecting SCM option			RF			
Fingers Bend (available only when selecting SCM) B1 (Straight), B2 (Standard) , B3 (Extra Bend)			B1/B2 /B3				+	
Zipper	Zipper (p.25) (plastic)		PZ	+	+	+	✓	
	Glue To Socket (p.25) (prosthetic socket is required)		GTS		+	+		

How to order : See page 146

Please use the product codes from previous page.

Example:

102LSL - F - L - CM1	-	D3P2 - X - 2D - SC	-	HF - RF
Basic specification		Options: Aesthetics and Surface Enhancement	Options: Structural Changes	

How to measure : See page 147

Female, Child M1

Model 200 series and Single finger (pg:50) Thickness: 1-1.8mm (mm)

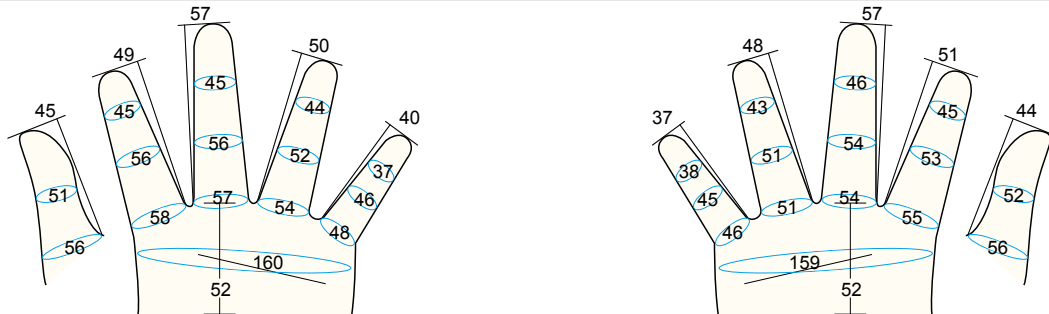

Model 103 (pg:49) Thickness: 2-2.5mm (mm)

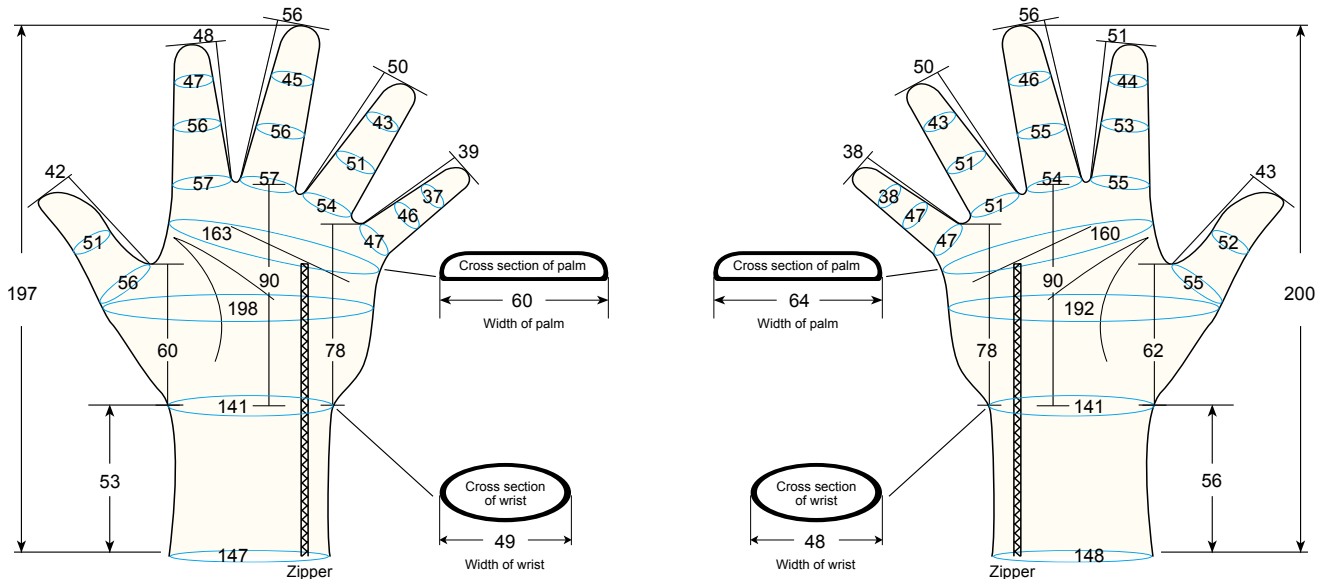

Model 101L, 102LS, 102L, 101LL, 102LSL, 102LL (pg:48) Thickness: 2-2.5mm (mm)

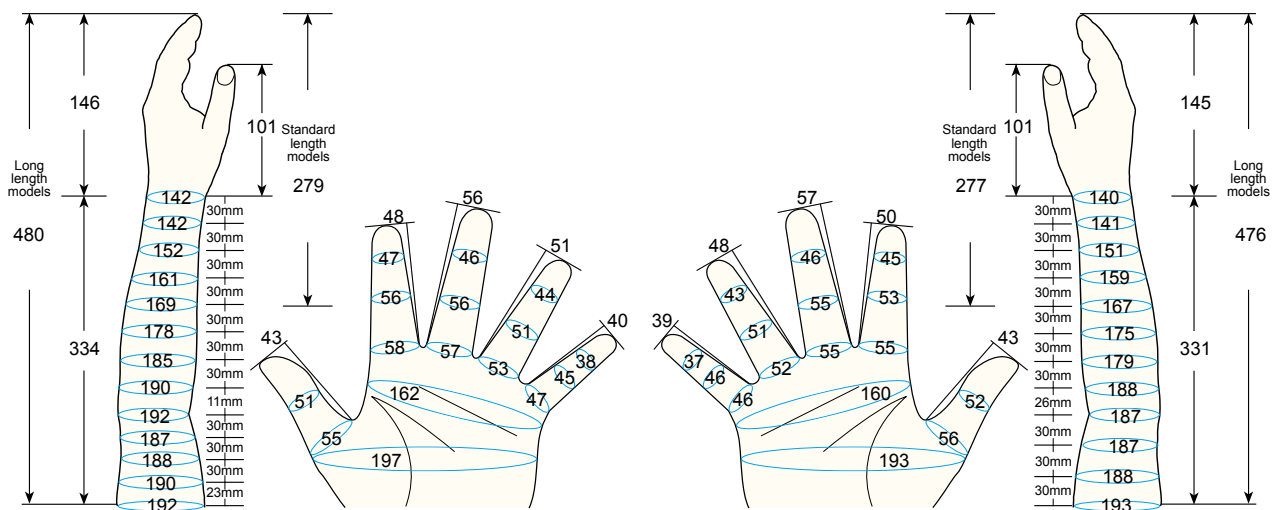

• All above information are for reference only •
• Please ask for more detail information •

Regal Silicone Prostheses

Upgrade Option

Myo-Electric & Mechanical Gloves

Gloves, Passive & Partial Hands, Digits

Footcovers

Leg / Arm Sleeve Maxillofacial / Accessories

FAQ & Warranty

Product: Silicone prosthetic glove

Model: 101L, 102L, 102LS, 101LL, 102LL, 102LSL, 103, 200, Single finger

Size: Male, Child S, Female, Child S



- ✓ = Standard feature
- O = Optional feature (no extra cost)
- + = Optional feature (extra cost)

Product Structure (List of all available features of each Model and Size)

Product features description				Models					
Code				101L, 101LL	102L, 102LL	102LS, 102LSL	103	200 & Finger	
Basic Spec	Gender, Size (Code: M-CS / F-CS)			✓	✓	✓	✓	✓	
	Side			L / R	✓	✓	✓	✓	
	Color - Single (use color sample from Regal)			✓	✓	✓	✓	✓	
Semi-Custom Made (p.7)				SCM	+	+	+	+	
Options: Aesthetics and Surface Enhancement	Color (p.14)	Dual Coloring Dorsal / Palmar (use color sample from Regal)		D/P	+	+	+	+	
		Custom Coloring (color sample is required)		CC	+	+	+	+	
	Nails, Hairs	X Series (p.16)			X	+	+	+	+
		- Hair Dimension (available only when selecting X series)		2D / 3D	+	+	+	+	+
		- Hair Color (available only when selecting X series) BB (Brown-Black), BR (Brown), BL (Black)		BB/BR /BL	+	+	+	+	+
		Acrylic Nails (p.17)			ACRN	+	+	+	+
	Smooth Coating	Smooth Coating (p.19)			SC	+	+	+	+
Options: Structural Changes	Wrist Connector (p.20)	- External threaded stud, Metric		EX-MT			✓ silicone filling		
		- Internal, Metric		IN-MT			O silicone filling		
		- External threaded stud, Imperial		EX-IP			O silicone filling		
		- Internal, Imperial		IN-IP			O silicone filling		
	Custom Filling (p.21)	- Foam		F		+		+	
		- Silicone		S		+		+	
		- Foam and Silicone (available depends on the length of the residual limb p.21)		F+S		+		+	
	Fingers Construction (p.23)	Wired Fingers	(with filling)	(available depends on the size of Silicone Prostheses & the length of residual limb p.23)	W		✓		
		Hinged Fingers			HF				
		Reinforced Fingers * fingers with RF may be larger in circumference * not available when selecting SCM option			RF				
Fingers Bend (available only when selecting SCM) B1 (Straight), B2 (Standard), B3 (Extra Bend)			B1/B2 /B3				+		
Zipper	Zipper (p.25) (plastic)			PZ	+	+	✓		
Glue To Socket (p.25) (prosthetic socket is required)				GTS		+			

How to order : See page 146

Please use the product codes from previous page.

Example:

102LSL - M - L - CS	-	D3P2 - X - 2D - SC	-	HF - RF
---------------------	---	--------------------	---	---------

Basic specification

Options:
Aesthetics and Surface Enhancement

Options:
Structural Changes

How to measure : See page 147

Male, Child S / Female, Child S

Model 200 series and Single finger (pg:50)

Thickness: 1-1.8mm

(mm)

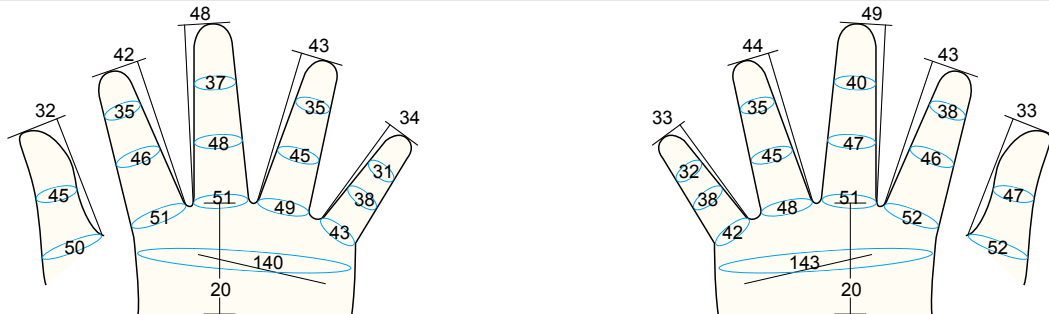

Model 103 (pg:49)

Thickness: 2-2.5mm

(mm)

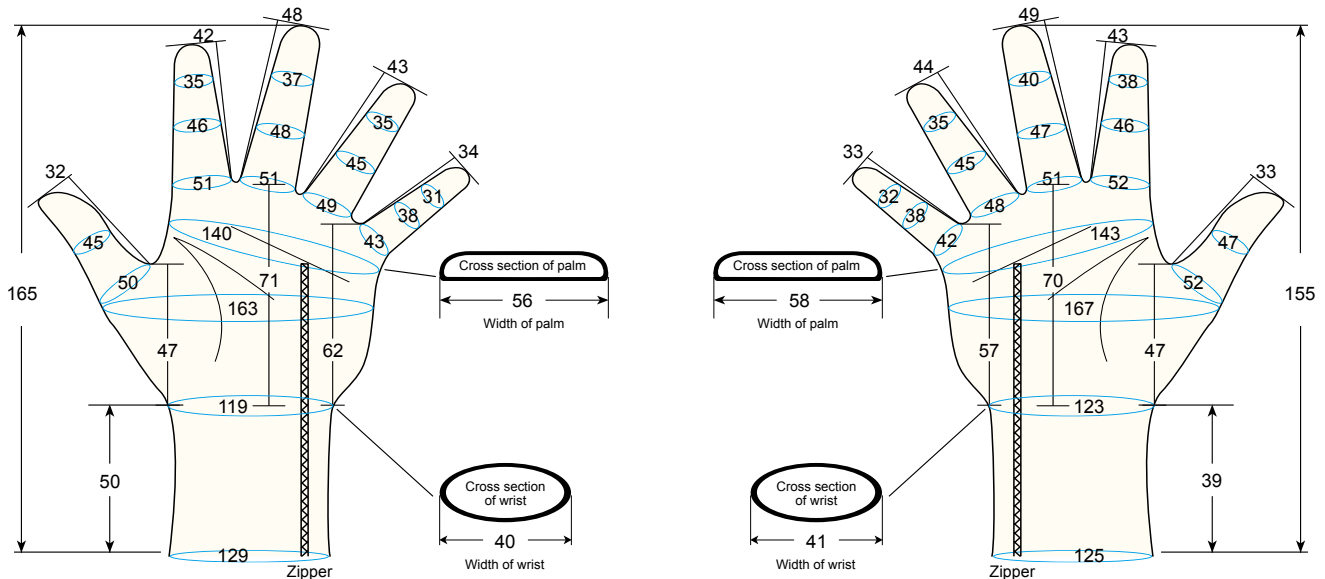

Model 101L, 102LS, 102L, 101LL, 102LSL, 102LL (pg:48)

Thickness: 2-2.5mm

(mm)

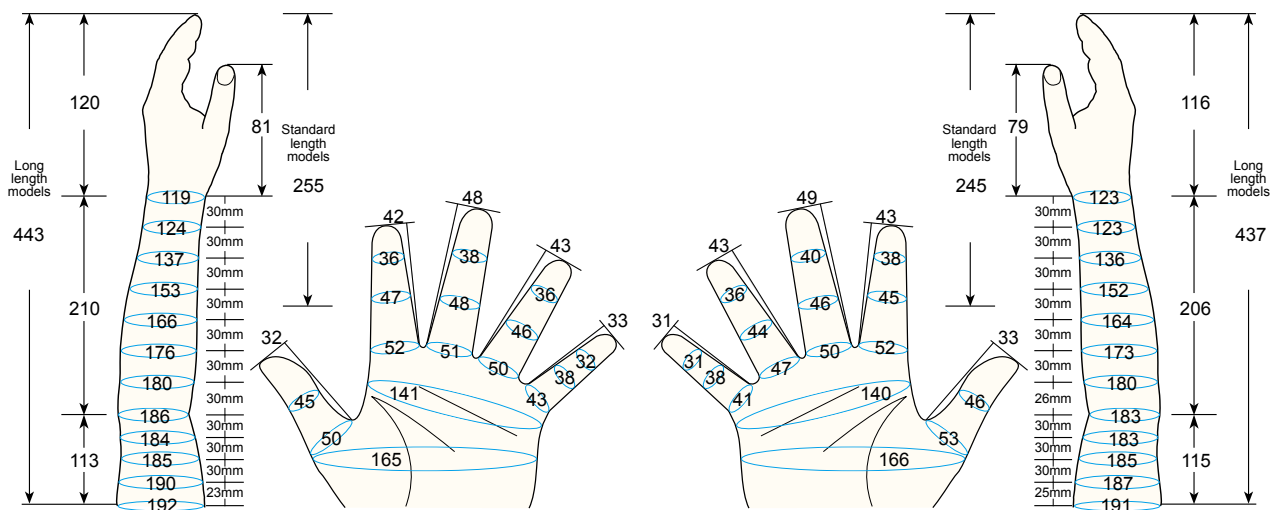

• All above information are for reference only •
• Please ask for more detail information •

Regal Silicone Prostheses

Product: Silicone prosthetic glove

Model: 101L, 102L, 102LS,
101LL, 102LL, 102LSL
103
200, Single finger

Size: Female, Child S1



✓ = Standard feature
O = Optional feature (no extra cost)
+ = Optional feature (extra cost)

Product Structure (List of all available features of each Model and Size)

Product features description				Models				
Code				101L, 101LL	102L, 102LL	102LS, 102LSL	103	200 & Finger
Basic Spec	Gender, Size			F-CS1	✓	✓	✓	✓
	Side			L / R	✓	✓	✓	✓
	Color - Single (use color sample from Regal)				✓	✓	✓	✓
Semi-Custom Made (p.7)				SCM	+	+	+	+
Options: Aesthetics and Surface Enhancement	Color (p.14)	Dual Coloring Dorsal / Palmar (use color sample from Regal)		D/P	+	+	+	+
		Custom Coloring (color sample is required)		CC	+	+	+	+
	Nails, Hairs	X Series (p.16)		X	+	+	+	+
		- Hair Dimension (available only when selecting X series)		2D / 3D	+	+	+	+
		- Hair Color (available only when selecting X series) BB (Brown-Black), BR (Brown), BL (Black)		BB/BR /BL	+	+	+	+
		Acrylic Nails (p.17)		ACRN	+	+	+	+
	Smooth Coating	Smooth Coating (p.19)		SC	+	+	+	+
Options: Structural Changes	Wrist Connector (p.20)	- External threaded stud, Metric		EX-MT			✓ silicone filling	
		- Internal , Metric		IN-MT			O silicone filling	
		- External threaded stud, Imperial		EX-IP			O silicone filling	
		- Internal, Imperial		IN-IP			O silicone filling	
	Custom Filling (p.21)	- Foam		F		+		+
		- Silicone		S		+		+
		- Foam and Silicone		(available depends on the length of the residual limb p.21) F+S		+		+
	Fingers Construction (p.23)	Wired Fingers	(with filling)	(available depends on the size of Silicone Prostheses & the length of residual limb p.23)	W		✓	
		Hinged Fingers			HF			
		Reinforced Fingers * fingers with RF may be larger in circumference * not available when selecting SCM option			RF			
Fingers Bend (available only when selecting SCM) B1 (Straight), B2 (Standard) , B3 (Extra Bend)			B1/B2 /B3				+	
Zipper	Zipper (p.25) (plastic)		PZ	+	+	+	✓	
	Glue To Socket (p.25) (prosthetic socket is required)		GTS		+	+		

How to order : See page 146

Please use the product codes from previous page.

Example:

102LSL - F - L - CS1	-	D3P2 - X - 2D - SC	-	HF - RF
Basic specification		Options: Aesthetics and Surface Enhancement	Options: Structural Changes	

How to measure : See page 147

Female, Child S1

Model 200 series and Single finger (pg:50) Thickness: 1-1.8mm (mm)

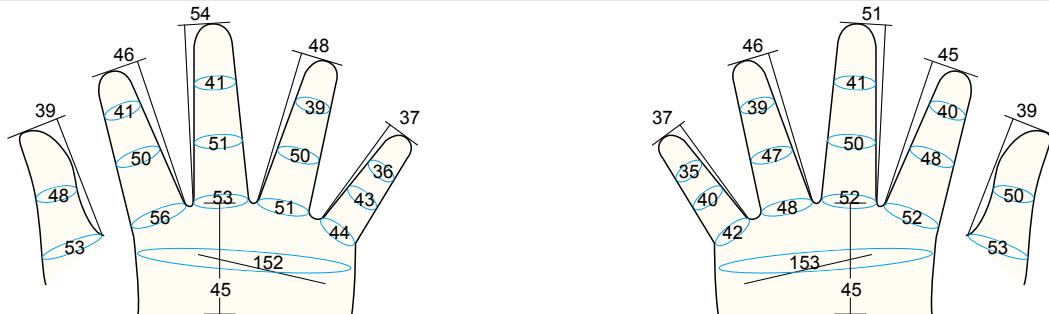

Model 103 (pg:49) Thickness: 2-2.5mm (mm)

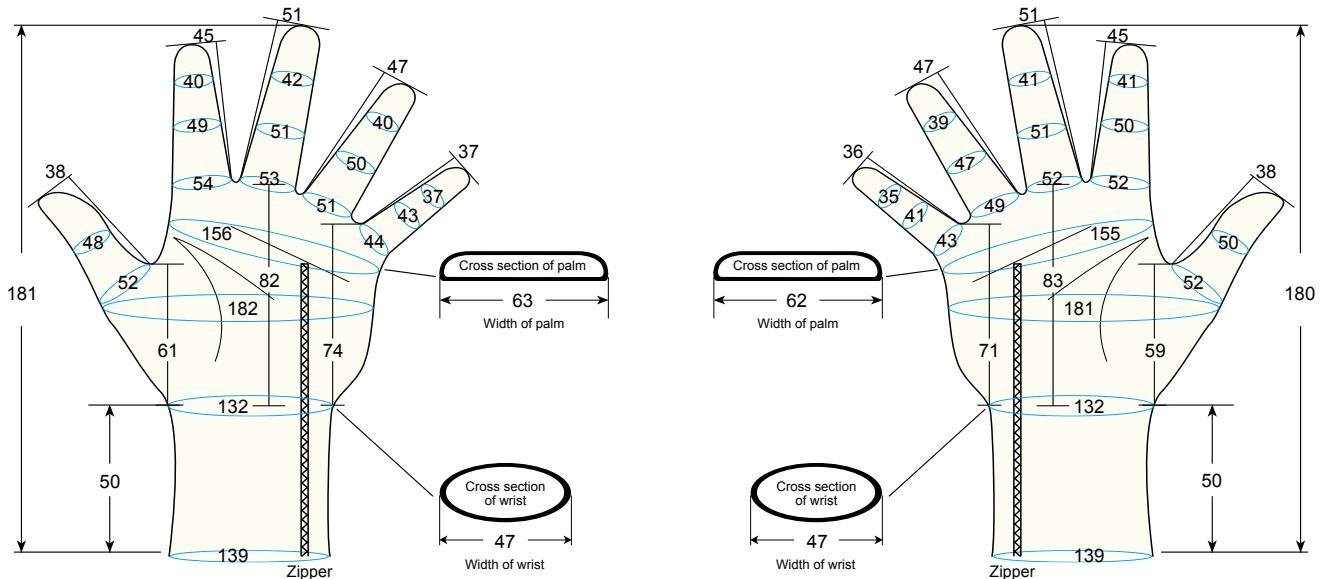

Model 101L, 102LS, 102L, 101LL, 102LSL, 102LL (pg:48) Thickness: 2-2.5mm (mm)

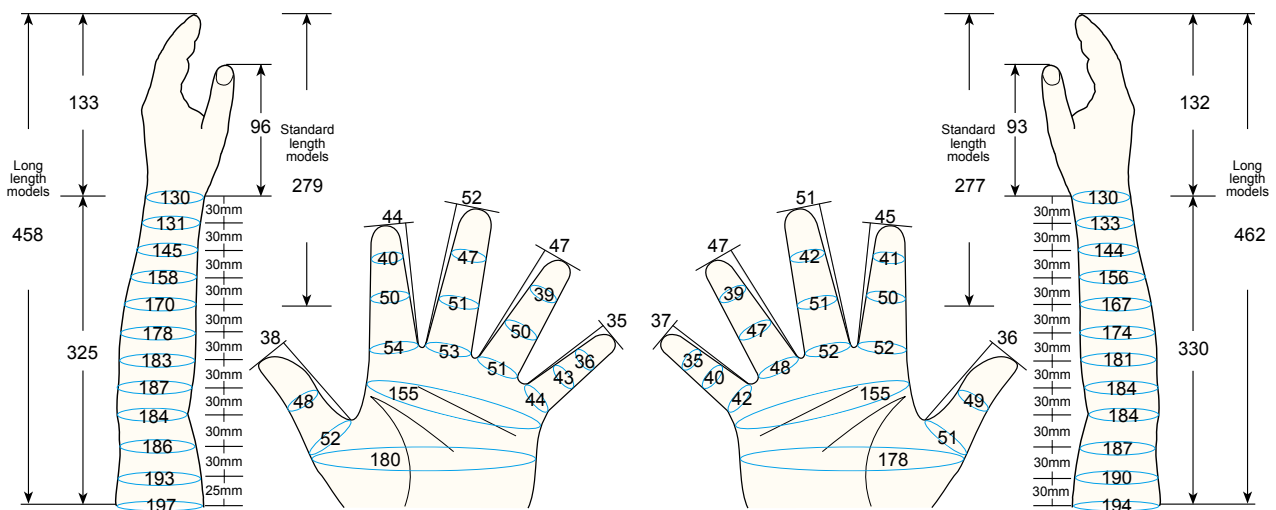

• All above information are for reference only •
• Please ask for more detail information •

Regal Silicone Prostheses

Product: Silicone prosthetic glove

Model: 101L, 102L, 102LS,
101LL, 102LL, 102LSL
103
200, Single finger

Size: Male, Child XS
Female, Child XS



✓ = Standard feature
O = Optional feature (no extra cost)
+ = Optional feature (extra cost)

Upgrade Option

Myo-Electric & Mechanical Gloves

Gloves, Passive & Partial Hands, Digits

Footcovers

Leg / Arm Sleeve Maxillofacial / Accessories

FAQ & Warranty

Product Structure (List of all available features of each Model and Size)

Product features description				Models				
		Code	101L, 101LL	102L, 102LL	102LS, 102LSL	103	200 & Finger	
Basic Spec	Gender, Size (Code: M-CXS / F-CXS)		✓	✓	✓	✓	✓	
	Side	L / R	✓	✓	✓	✓	✓	
	Color - Single (use color sample from Regal)		✓	✓	✓	✓	✓	
Semi-Custom Made (p.7)		SCM	+	+	+	+	+	
Options: Aesthetics and Surface Enhancement	Color (p.14)	Dual Coloring Dorsal / Palmar (use color sample from Regal)	D/P	+	+	+	+	
		Custom Coloring (color sample is required)	CC	+	+	+	+	
	Nails, Hairs	X Series (p.16)	X	+	+	+	+	
		- Hair Dimension (available only when selecting X series)	2D / 3D	+	+	+	+	
		- Hair Color (available only when selecting X series) BB (Brown-Black), BR (Brown), BL (Black)	BB/BR /BL	+	+	+	+	
		Acrylic Nails (p.17)	ACRN					
Smooth Coating	Smooth Coating (p.19)	SC	+	+	+	+		
Options: Structural Changes	Wrist Connector (p.20)	- External threaded stud, Metric	EX-MT			✓ silicone filling		
		- Internal, Metric	IN-MT			O silicone filling		
		- External threaded stud, Imperial	EX-IP			O silicone filling		
		- Internal, Imperial	IN-IP			O silicone filling		
	Custom Filling (p.21)	- Foam	F		+		+	
		- Silicone	S		+		+	
		- Foam and Silicone	(available depends on the length of the residual limb p.21) F+S		+		+	
	Fingers Construction (p.23)	Wired Fingers	(with filling) (available depends on the size of Silicone Prostheses & the length of residual limb p.23) W		✓	✓		
		Hinged Fingers	HF					
		Reinforced Fingers * fingers with RF may be larger in circumference * not available when selecting SCM option	RF					
Fingers Bend (available only when selecting SCM) B1 (Straight), B2 (Standard), B3 (Extra Bend)		B1/B2 /B3					+	
Zipper	Zipper (p.25) (plastic)	PZ	+	+	+	✓		
	Glue To Socket (p.25) (prosthetic socket is required)	GTS		+	+			

How to order : See page 146

Please use the product codes from previous page.

Example:

102LSL - M - L - CXS	-	D3P2 - X - 2D - SC	-	HF - RF
----------------------	---	--------------------	---	---------

Basic specification

Options:
Aesthetics and Surface Enhancement

Options:
Structural Changes

How to measure : See page 147

Male, Child XS / Female, Child XS

Model 200 series and Single finger (pg:50)

Thickness: 1-1.8mm

(mm)

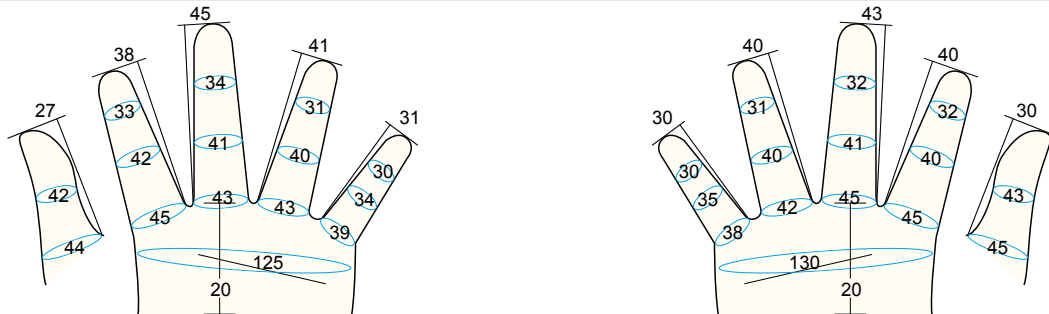

Model 103 (pg:49)

Thickness: 2-2.5mm

(mm)

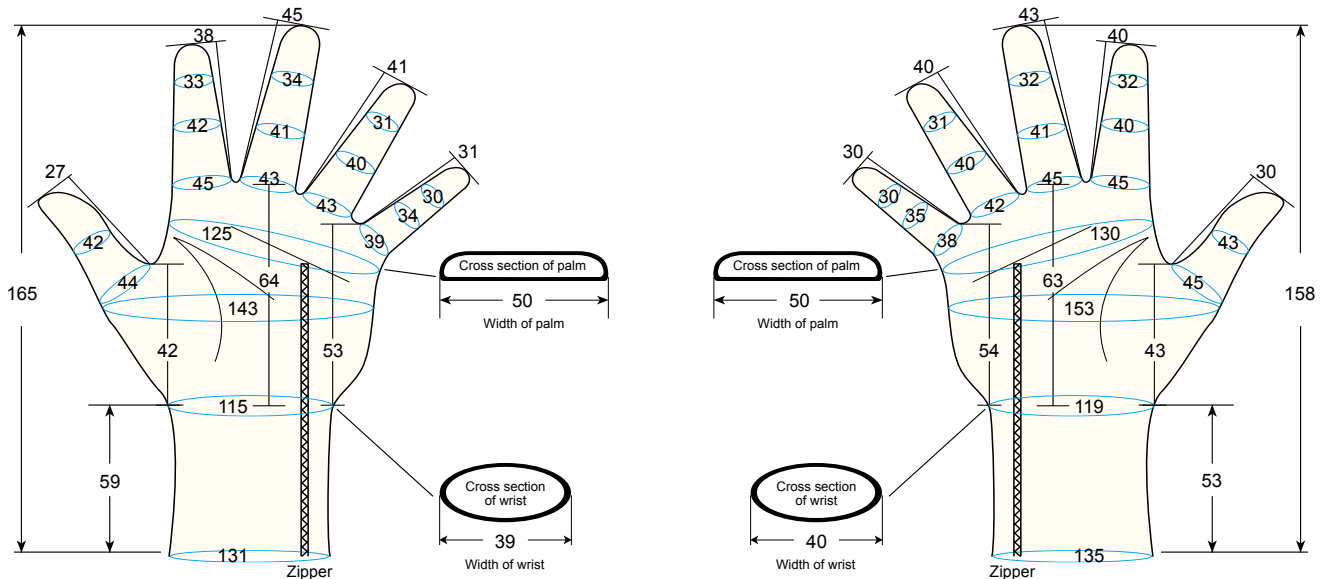

Model 101L, 102LS, 102L, 101LL, 102LSL, 102LL (pg:48)

Thickness: 2-2.5mm

(mm)

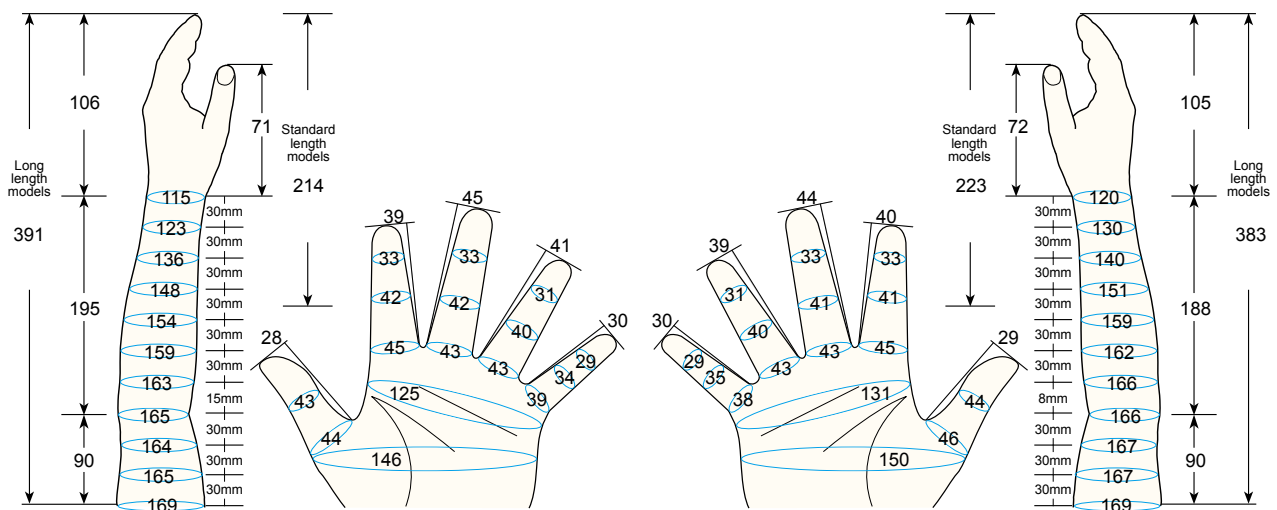

• All above information are for reference only •
• Please ask for more detail information •

Silicone Footcover

Model HDSFHT-ER, HDSFHT

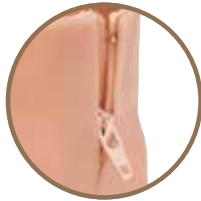

Plastic Zipper is integrated as standard feature



Carbon fiber energy restoring footplate

Product descriptions:

- High Definition Silicone HighTop Footcover (HDSFHT) is designed especially suitable for short amputation such as chopart or syme cases who require more stable walking feel
- Compare to the Model HDSF, HDSFHT has higher ankletop and thicker silicone and reinforced fabric to provide more stable support
- Optional carbon footplate provides further stability control at heel lift
- Model HDSFHT-ER: Footcover with carbon footplate embedded
- Model HDSFHT: Footcover without carbon footplate embedded
- Upgrade options: See our Complete Product Structure page 27

Applications:

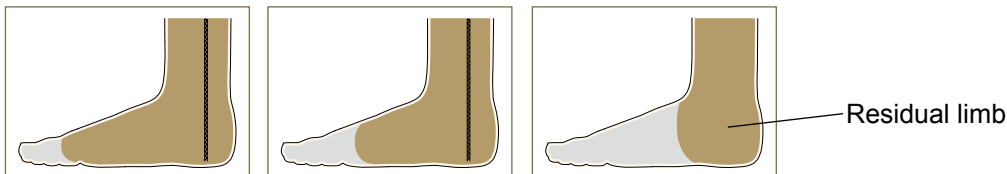

Size chart:

Model no.	HDSFHT-ER, HDSFHT													
Foot size (cm)	28	27	26	25	24	23.5	23	22	21	20	19	18	16	14
Page no.	P.110	P.112	P.114	P.116	P.118	P.120	P.122	P.124	P.126	P.128	P.130	P.132	P.134	P.136

Silicone Footcover

Model HDSF-ER, HDSF

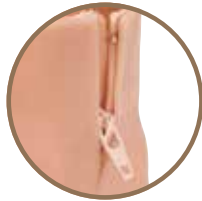

Plastic Zipper is integrated as standard feature



Carbon fiber energy restoring footplate

Product descriptions:

- High Definition Silicone Footcover, fine footprints, veins and knuckles
- Design for partial foot amputation
- Optional carbon footplate provides further stability control at heel lift
- Model HDSF-ER: Footcover with carbon footplate embedded
- Model HDSF: Footcover without carbon footplate embedded
- Upgrade options: See our Complete Product Structure page 27

Applications:

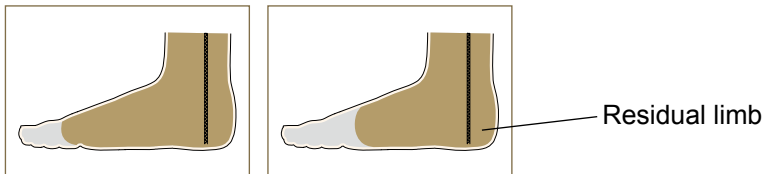

Size chart:

Model no.	HDSF-ER, HDSF											
Foot size (cm)	28	27	26	25	24	23.5	23	22	21	20	19	18
Page no.	P.110	P.112	P.114	P.116	P.118	P.120	P.122	P.124	P.126	P.128	P.130	P.132

Silicone Prosthetic toe

Model TOE

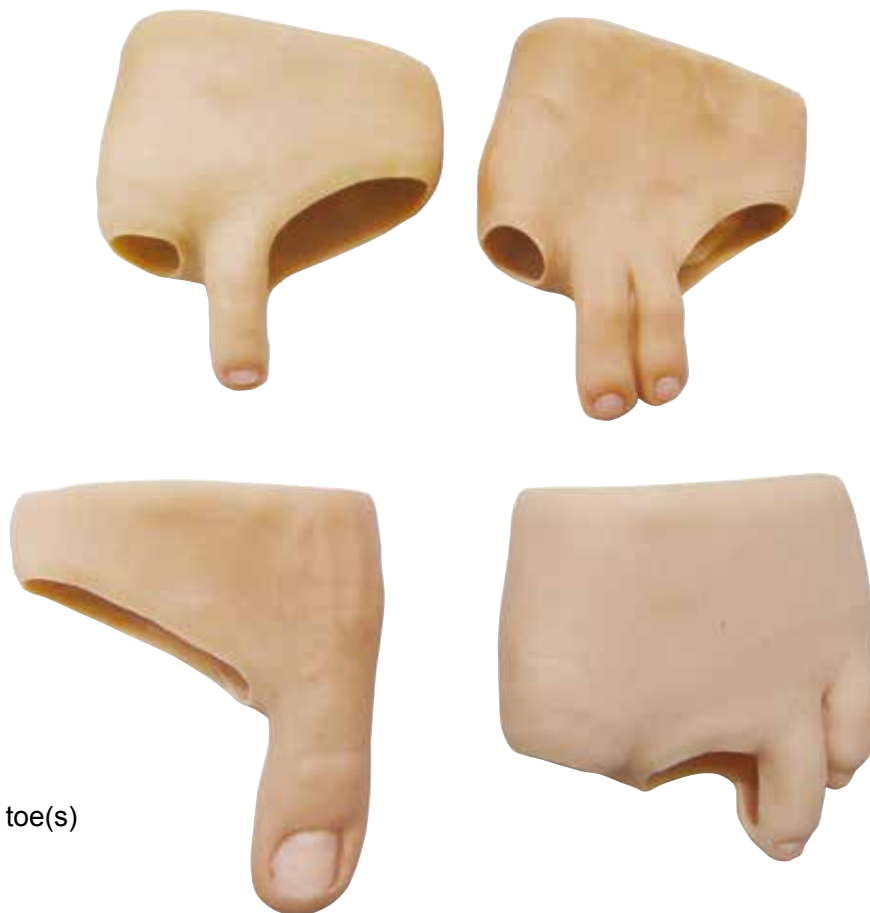

Product descriptions:

- High definition silicone prosthetic toe(s)
- Design for toe amputation

Silicone TOE series

Number of Toes amputated	Recommended Models	Footband (Standard Footband is set at the metatarsal)
Single Toe	TOE1S	Without Footband
Single Toe	TOE1C, TOE2C, TOE3C, TOE4C, TOE5C	With Footband
Two Toes	TOE12C, TOE13C, TOE14C, TOE15C, TOE23C, TOE24C, TOE25C, TOE34C, TOE35C, TOE45C	With Footband
Three Toes	TOE123C, TOE124C, TOE125C, TOE134C, TOE135C, TOE145C, TOE234C, TOE235C, TOE245C, TOE345C	With Footband
Four or Five Toes	HDSFHT, HDSF	-

How to Order :

For Model TOE Series toe amputation: **Order form S5**
(All TOE series must be ordered in Semi-Custom Made (SCM) and with Silicone Filling)



TOE1S – Great Toe without Footband



TOE1C – Great Toe with Footband



TOE2C – Second Toe with Footband



TOE23C – Second and Third Toe with Footband



TOE34C - Third and Forth Toe with Footband
(Customer may request to cut the Footband to desired shape and length)



Without filling



Silicone filling

Upgrade Option

Myo-Electric & Mechanical Gloves

Gloves, Passive & Partial Hands, Digits

Footcovers

Leg / Arm Sleeve
Maxillofacial / Accessories

FAQ & Warranty

Regal silicone prosthetic footcovers - Size measurement chart

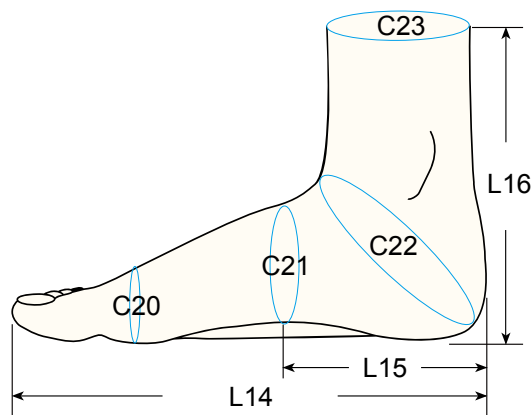

For Model HDSFHT-ER, HDSFHT (partial foot amputation)

Model HDSFHT-ER Thickness: Dorsal: 3.5mm Plantar: 9.5mm
 Model HDSFHT Thickness: Dorsal: 3.5mm Plantar: 3.5mm

Size	Side	(mm)							Catalogue 2015 page
		C20	C21	C22	C23	L14	L15	L16	
28	Left	240	263	357	239	280	115	168	P.110
28	Right	250	265	360	241	280	115	168	P.110
27	Left	240	248	350	233	270	128	165	P.112
27	Right	240	247	350	235	270	128	165	P.112
26	Left	238	243	325	223	260	112	165	P.114
26	Right	240	245	340	227	260	112	165	P.114
25	Left	240	238	335	225	250	115	165	P.116
25	Right	238	240	330	225	250	115	165	P.116
24	Left	241	235	323	208	240	110	165	P.118
24	Right	243	235	320	212	240	110	165	P.118
23.5	Left	221	235	318	215	235	101	165	P.120
23.5	Right	223	235	318	218	235	101	165	P.120
23	Left	214	217	299	203	230	100	165	P.122
23	Right	212	215	297	203	230	100	165	P.122
22	Left	215	223	288	192	220	90	150	P.124
22	Right	217	225	288	190	220	90	150	P.124
21	Left	210	218	282	200	210	90	150	P.126
21	Right	210	215	280	200	210	90	150	P.126
20	Left	191	205	268	193	200	85	150	P.128
20	Right	191	200	268	196	200	85	150	P.128
19	Left	188	203	260	190	190	85	135	P.130
19	Right	190	200	257	184	190	85	135	P.130
18	Left	175	180	242	185	180	80	135	P.132
18	Right	178	180	237	187	180	80	135	P.132
16	Left	151	164	214	165	160	75	94	P.134
16	Right	148	160	211	164	160	75	93	P.134
14	Left	136	146	200	153	140	75	85	P.136
14	Right	137	147	197	152	140	75	88	P.136

The above information is for reference only. Please contact our technicians if you are not sure which size to choose.

Regal silicone prosthetic footcovers - Size measurement chart

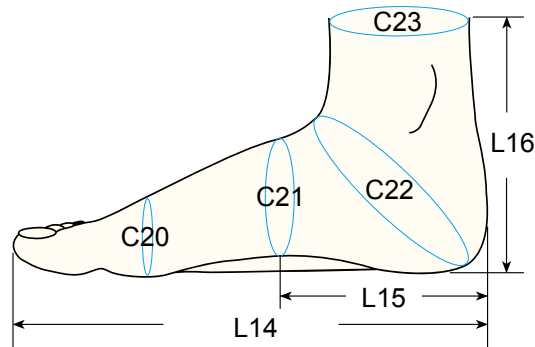

For Model HDSF-ER, HDSF (partial foot amputation)

Model HDSF-ER Thickness: Dorsal: 2.8mm Plantar: 9.5mm
 Model HDSF Thickness: Dorsal: 2.8mm Plantar: 3.5mm

Size	Side	(mm)							Catalogue 2015 page
		C20	C21	C22	C23	L14	L15	L16	
28	Left	248	257	360	238	280	126	125	P.110
28	Right	246	255	365	243	280	132	125	P.110
27	Left	240	248	350	228	270	123	125	P.112
27	Right	240	247	350	225	270	125	125	P.112
26	Left	235	243	330	215	260	115	125	P.114
26	Right	240	245	340	224	260	123	125	P.114
25	Left	240	238	338	225	250	115	115	P.116
25	Right	238	240	335	225	250	115	115	P.116
24	Left	240	235	320	214	240	113	115	P.118
24	Right	242	233	320	215	240	113	115	P.118
23.5	Left	220	227	315	213	235	115	115	P.120
23.5	Right	220	232	318	215	235	110	115	P.120
23	Left	217	215	300	205	230	103	100	P.122
23	Right	208	216	302	205	230	103	100	P.122
22	Left	212	222	285	195	220	93	100	P.124
22	Right	212	222	288	195	220	93	100	P.124
21	Left	210	215	285	198	210	95	95	P.126
21	Right	205	206	280	198	210	95	95	P.126
20	Left	188	207	270	203	200	85	83	P.128
20	Right	188	205	268	200	200	85	83	P.128
19	Left	188	200	259	188	190	80	85	P.130
19	Right	188	195	259	180	190	80	85	P.130
18	Left	178	180	238	180	180	75	83	P.132
18	Right	180	184	238	180	180	75	83	P.132

The above information is for reference only. Please contact our technicians if you are not sure which size to choose.

Regal Silicone Prostheses

Upgrade Option

Myo-Electric & Mechanical Gloves

Gloves, Passive & Partial Hands, Digits

Footcovers

Leg / Arm Sleeve Maxillofacial / Accessories

FAQ & Warranty

Product: Silicone prosthetic footcover

Model: HDSFHT-ER, HDSF-ER (with carbon footplate)
HDSFHT, HDSF

Size: 28cm

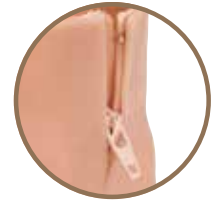

Plastic Zipper is integrated as standard feature

Carbon fiber energy restoring footplate

- ✓ = Standard feature
- O = Optional feature (no extra cost)
- + = Optional feature (extra cost)

Product Structure (List of all available features of each Model and Size)

Product features description			Models			
		Code	HDSFHT-ER, HDSF-ER	HDSFHT, HDSF		
Basic Spec	Size	28	✓	✓		
	Side	L / R	✓	✓		
	Color - Single (use color sample from Regal)		✓	✓		
	Carbon Fiber Footplate		✓			
	Semi-Custom Made (p.7)	SCM	+	+		
Options: Aesthetics and Surface Enhancement	Color (p.17)	Dual Coloring Dorsal / Palmar (use color sample from Regal)	D/P	+	+	
		Custom Coloring (color sample is required)	CC	+	+	
	Nails, Hairs	X Series (p.16)	X	+	+	
		- Hair Dimension (available only when selecting X series)	2D / 3D	+	+	
		- Hair Color (available only when selecting X series) BB (Brown-Black), BR (Brown), BL (Black)	BB/BR /BL	+	+	
		Acrylic Nails (p.17)	ACRN	+	+	
	Smooth Coating	Smooth Coating (p.19)	SC	+	+	
Options: Structural Changes	Custom Filling (p.21)	- Foam	F	+	+	
		- Silicone	S	+	+	
		- Foam and Silicone	F+S	+	+	
	Fingers Construction (p.23)	Wired Fingers	(with filling) (available depends on the size of Silicone Prostheses & the length of residual limb p.23)	W		
		Hinged Fingers		HF		
		Reinforced Fingers	* fingers with RF may be larger in circumference * not available when selecting SCM option	RF		
		Fingers Bend (available only when selecting SCM) B1 (Straight), B2 (Standard) , B3 (Extra Bend)		B1/B2 /B3		
Zipper	Zipper (p.25) (plastic)	PZ	✓	✓		
	Glue To Socket (p.25) (prosthetic socket is required)	GTS				

How to order : See page 146

Please use the product codes from previous page.

Example:

HDSFHT - ER - L - 28 - 3 - SCM	-	ACRN - SC	-	S
Basic specification		Options: Aesthetics and Surface Enhancement		Options: Structural Changes

Measurements :

28cm

Model HDSFHT-ER (pg:104)	Thickness: Dorsal: 3.5mm	Plantar: 9.5mm	(mm)
Model HDSFHT (pg:104)	Thickness: Dorsal: 3.5mm	Plantar: 3.5mm	

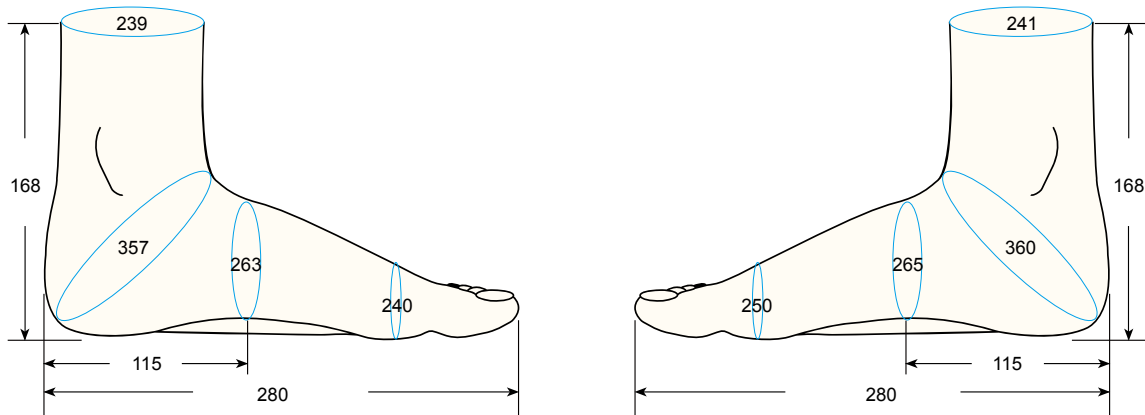

Model HDSF-ER (pg:105)	Thickness: Dorsal: 2.8mm	Plantar: 9.5mm	(mm)
Model HDSF (pg:105)	Thickness: Dorsal: 2.8mm	Plantar: 3.5mm	

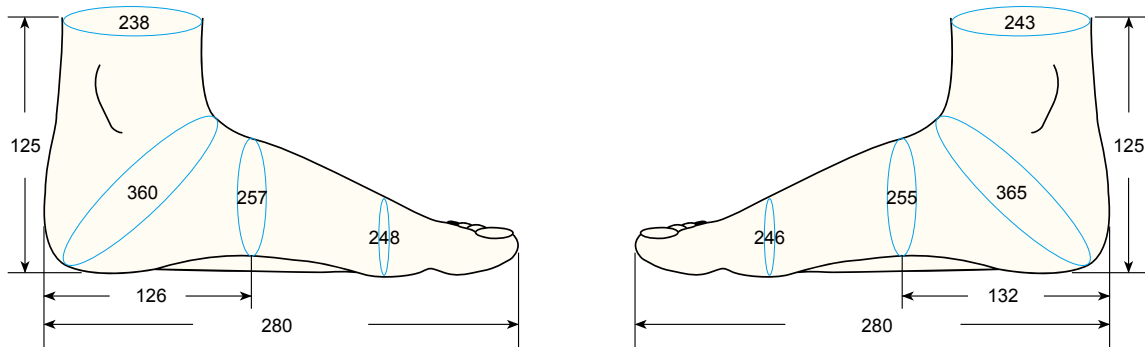

• All above information are for reference only •
• Please ask for more detail information •

Regal Silicone Prostheses

Product: Silicone prosthetic footcover

Model: HDSFHT-ER, HDSF-ER (with carbon footplate)
HDSFHT, HDSF

Size: 27cm

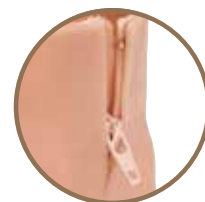

Plastic Zipper is integrated as standard feature

Carbon fiber energy restoring footplate

- ✓ = Standard feature
- O = Optional feature (no extra cost)
- + = Optional feature (extra cost)

Upgrade Option

Myo-Electric & Mechanical Gloves

Gloves, Passive & Partial Hands, Digits

Footcovers

Leg / Arm Sleeve
Maxillofacial / Accessories

FAQ & Warranty

Product Structure (List of all available features of each Model and Size)

Product features description			Models			
			HDSFHT-ER, HDSF-ER	HDSFHT, HDSF		
Basic Spec	Size	27	✓	✓		
	Side	L / R	✓	✓		
	Color - Single (use color sample from Regal)		✓	✓		
	Carbon Fiber Footplate		✓			
	Semi-Custom Made (p.9)	SCM	+	+		
Options: Aesthetics and Surface Enhancement	Color (p.14)	Dual Coloring Dorsal / Palmar (use color sample from Regal)	D/P	+	+	
		Custom Coloring (color sample is required)	CC	+	+	
	Nails, Hairs	X Series (p.16)	X	+	+	
		- Hair Dimension (available only when selecting X series)	2D / 3D	+	+	
		- Hair Color (available only when selecting X series) BB (Brown-Black), BR (Brown), BL (Black)	BB/BR /BL	+	+	
		Acrylic Nails (p.17)	ACRN	+	+	
	Smooth Coating	Smooth Coating (p.19)	SC	+	+	
Options: Structural Changes	Custom Filling (p.21)	- Foam	F	+	+	
		- Silicone	S	+	+	
		- Foam and Silicone	(available depends on the length of the residual limb p.21) F+S	+	+	
	Fingers Construction (p.23)	Wired Fingers	(with filling) (available depends on the size of Silicone Prostheses & the length of residual limb p.23)	W		
		Hinged Fingers		HF		
		Reinforced Fingers * fingers with RF may be larger in circumference * not available when selecting SCM option		RF		
		Fingers Bend (available only when selecting SCM) B1 (Straight), B2 (Standard) , B3 (Extra Bend)		B1/B2 /B3		
Zipper	Zipper (p.25) (plastic)	PZ	✓	✓		
	Glue To Socket (p.25) (prosthetic socket is required)	GTS				

How to order : See page 146

Please use the product codes from previous page.

Example:

HDSFHT - ER - L - 27 - 3 - SCM	-	ACRN - SC	-	S
Basic specification		Options: Aesthetics and Surface Enhancement		Options: Structural Changes

Measurements :

27cm

Model HDSFHT-ER (pg:104)	Thickness: Dorsal: 3.5mm	Plantar: 9.5mm	(mm)
Model HDSFHT (pg:104)	Thickness: Dorsal: 3.5mm	Plantar: 3.5mm	

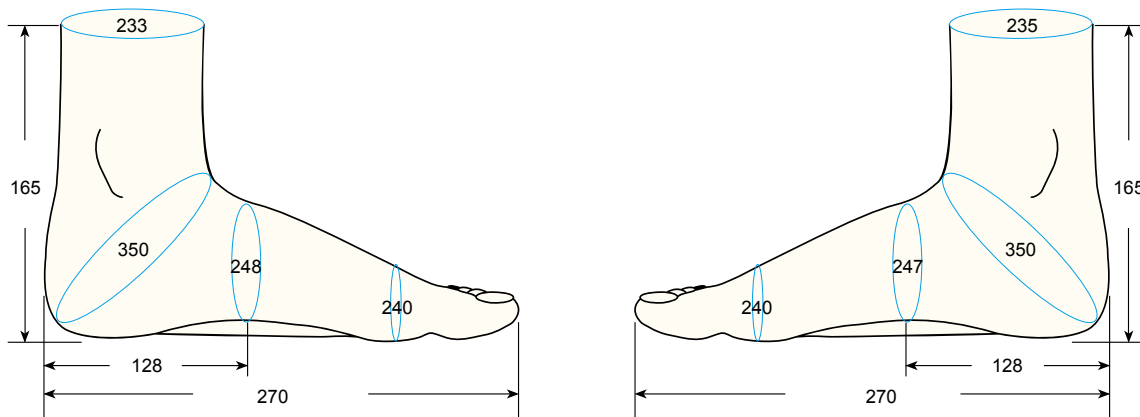

Model HDSF-ER (pg:105)	Thickness: Dorsal: 2.8mm	Plantar: 9.5mm	(mm)
Model HDSF (pg:105)	Thickness: Dorsal: 2.8mm	Plantar: 3.5mm	

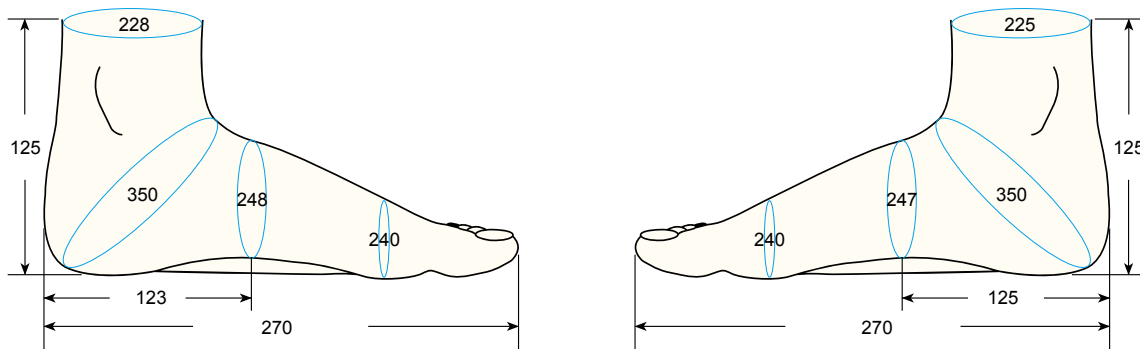

• All above information are for reference only •
• Please ask for more detail information •

Regal Silicone Prostheses

Upgrade Option

Myo-Electric & Mechanical Gloves

Gloves, Passive & Partial Hands, Digits

Footcovers

Leg / Arm Sleeve Maxillofacial / Accessories

FAQ & Warranty

Product: Silicone prosthetic footcover

Model: HDSFHT-ER, HDSF-ER (with carbon footplate)
HDSFHT, HDSF

Size: 26cm

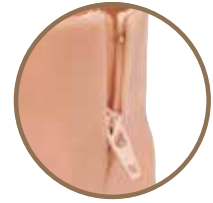

Plastic Zipper is integrated as standard feature

Carbon fiber energy restoring footplate

- ✓ = Standard feature
- O = Optional feature (no extra cost)
- + = Optional feature (extra cost)

Product Structure (List of all available features of each Model and Size)

Product features description			Models		
		Code	HDSFHT-ER, HDSF-ER	HDSFHT, HDSF	
Basic Spec	Size	26	✓	✓	
	Side	L / R	✓	✓	
	Color - Single (use color sample from Regal)		✓	✓	
	Carbon Fiber Footplate		✓		
	Semi-Custom Made (p.7)	SCM	+	+	
Options: Aesthetics and Surface Enhancement	Color (p.14)	Dual Coloring Dorsal / Palmar (use color sample from Regal)	D/P	+	+
		Custom Coloring (color sample is required)	CC	+	+
	Nails, Hairs	X Series (p.16)	X	+	+
		- Hair Dimension (available only when selecting X series)	2D / 3D	+	+
		- Hair Color (available only when selecting X series) BB (Brown-Black), BR (Brown), BL (Black)	BB/BR /BL	+	+
		Acrylic Nails (p.17)	ACRN	+	+
	Smooth Coating	Smooth Coating (p.19)	SC	+	+
Options: Structural Changes	Custom Filling (p.21)	- Foam	F	+	+
		- Silicone	S	+	+
		- Foam and Silicone	(available depends on the length of the residual limb p.21) F+S	+	+
	Fingers Construction (p.23)	Wired Fingers	(with filling) (available depends on the size of Silicone Prostheses & the length of residual limb p.23) W		
		Hinged Fingers	HF		
		Reinforced Fingers * fingers with RF may be larger in circumference * not available when selecting SCM option	RF		
		Fingers Bend (available only when selecting SCM) B1 (Straight), B2 (Standard), B3 (Extra Bend)	B1/B2 /B3		
Zipper	Zipper (p.25) (plastic)	PZ	✓	✓	
	Glue To Socket (p.25) (prosthetic socket is required)	GTS			

How to order : See page 146

Please use the product codes from previous page.

Example:

HDSFHT - ER - L - 26 - 3 - SCM	-	ACRN - SC	-	S
Basic specification		Options: Aesthetics and Surface Enhancement		Options: Structural Changes

Measurements :

26cm

Model HDSFHT-ER (pg:104)	Thickness: Dorsal: 3.5mm	Plantar: 9.5mm	(mm)
Model HDSFHT (pg:104)	Thickness: Dorsal: 3.5mm	Plantar: 3.5mm	

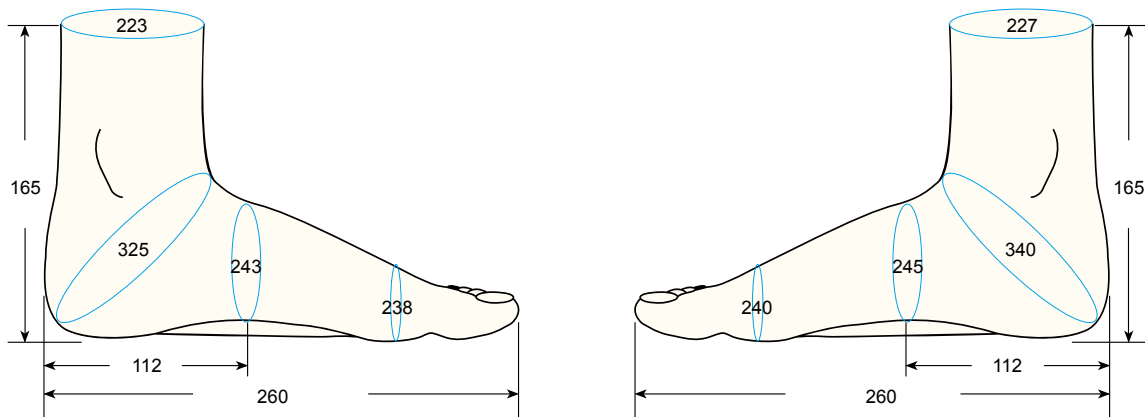

Model HDSF-ER (pg:105)	Thickness: Dorsal: 2.8mm	Plantar: 9.5mm	(mm)
Model HDSF (pg:105)	Thickness: Dorsal: 2.8mm	Plantar: 3.5mm	

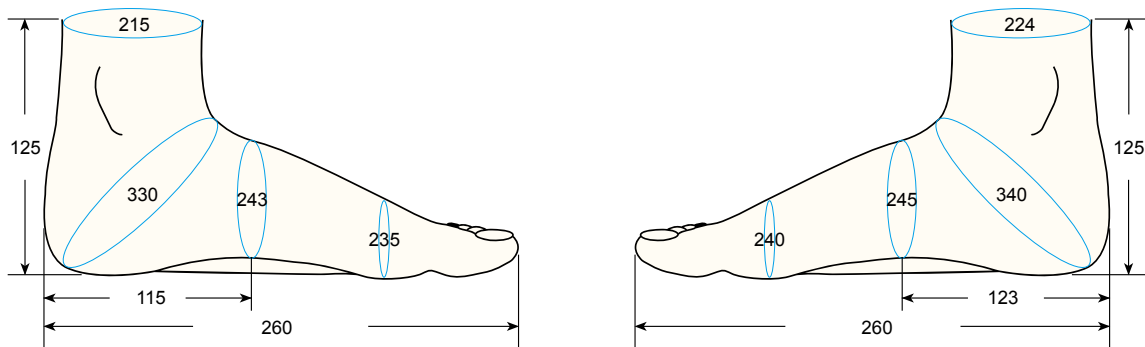

• All above information are for reference only •
• Please ask for more detail information •

Regal Silicone Prostheses

Product: Silicone prosthetic footcover

Model: HDSFHT-ER, HDSF-ER (with carbon footplate)
HDSFHT, HDSF

Size: 25cm



Plastic Zipper is integrated as standard feature

Carbon fiber energy restoring footplate

- ✓ = Standard feature
- O = Optional feature (no extra cost)
- + = Optional feature (extra cost)

Upgrade Option

Myo-Electric & Mechanical Gloves

Gloves, Passive & Partial Hands, Digits

Footcovers

Leg / Arm Sleeve
Maxillofacial / Accessories

FAQ & Warranty

Product Structure (List of all available features of each Model and Size)

Product features description			Models			
			HDSFHT-ER, HDSF-ER	HDSFHT, HDSF		
Basic Spec	Size	25	✓	✓		
	Side	L / R	✓	✓		
	Color - Single (use color sample from Regal)		✓	✓		
	Carbon Fiber Footplate		✓			
	Semi-Custom Made (p.7)	SCM	+	+		
Options: Aesthetics and Surface Enhancement	Color (p.14)	Dual Coloring Dorsal / Palmar (use color sample from Regal)	D/P	+	+	
		Custom Coloring (color sample is required)	CC	+	+	
	Nails, Hairs	X Series (p.16)	X	+	+	
		- Hair Dimension (available only when selecting X series)	2D / 3D	+	+	
		- Hair Color (available only when selecting X series) BB (Brown-Black), BR (Brown), BL (Black)	BB/BR /BL	+	+	
		Acrylic Nails (p.17)	ACRN	+	+	
	Smooth Coating	Smooth Coating (p.19)	SC	+	+	
Options: Structural Changes	Custom Filling (p.21)	- Foam	F	+	+	
		- Silicone	S	+	+	
		- Foam and Silicone	(available depends on the length of the residual limb p.21) F+S	+	+	
	Fingers Construction (p.23)	Wired Fingers	(with filling) (available depends on the size of Silicone Prostheses & the length of residual limb p.23)	W		
		Hinged Fingers		HF		
		Reinforced Fingers * fingers with RF may be larger in circumference * not available when selecting SCM option		RF		
	Fingers Bend (available only when selecting SCM) B1 (Straight), B2 (Standard) , B3 (Extra Bend)		B1/B2 /B3			
Zipper	Zipper (p.25) (plastic)		PZ	✓	✓	
	Glue To Socket (p.25) (prosthetic socket is required)		GTS			

How to order : See page 146

Please use the product codes from previous page.

Example:

HDSFHT - ER - L - 25 - 3 - SCM	-	ACRN - SC	-	S
Basic specification		Options: Aesthetics and Surface Enhancement		Options: Structural Changes

Measurements :

25cm

Model HDSFHT-ER (pg:104)	Thickness: Dorsal: 3.5mm	Plantar: 9.5mm	(mm)
Model HDSFHT (pg:104)	Thickness: Dorsal: 3.5mm	Plantar: 3.5mm	

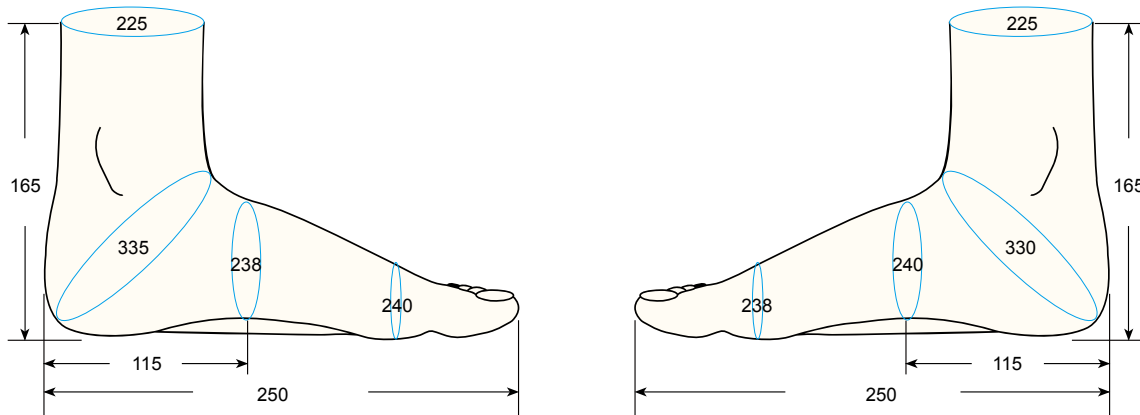

Model HDSF-ER (pg:105)	Thickness: Dorsal: 2.8mm	Plantar: 9.5mm	(mm)
Model HDSF (pg:105)	Thickness: Dorsal: 2.8mm	Plantar: 3.5mm	

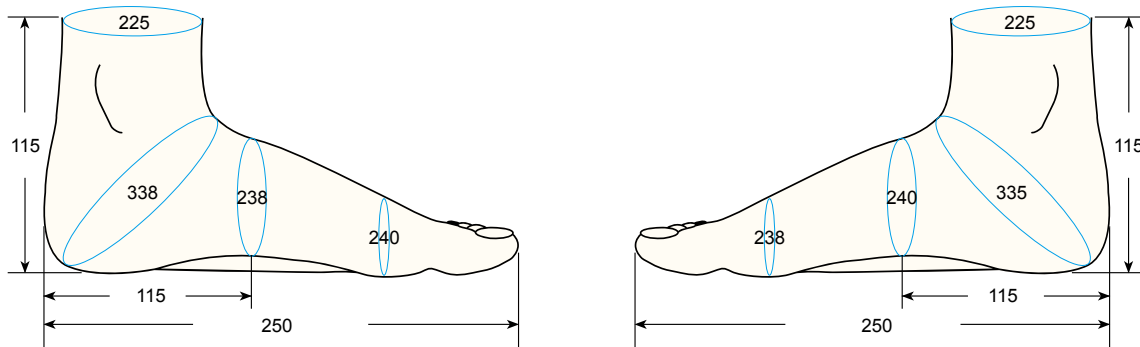

• All above information are for reference only •
• Please ask for more detail information •

Regal Silicone Prostheses

Product: Silicone prosthetic footcover

Model: HDSFHT-ER, HDSF-ER (with carbon footplate)
HDSFHT, HDSF

Size: 24cm

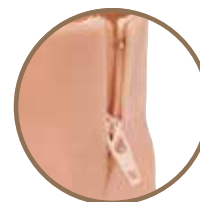

Plastic Zipper is integrated as standard feature

Carbon fiber energy restoring footplate

- ✓ = Standard feature
- O = Optional feature (no extra cost)
- + = Optional feature (extra cost)

Upgrade Option

Myo-Electric & Mechanical Gloves

Gloves, Passive & Partial Hands, Digits

Footcovers

Leg / Arm Sleeve Maxillofacial / Accessories

FAQ & Warranty

Product Structure (List of all available features of each Model and Size)

Product features description			Models			
			HDSFHT-ER, HDSF-ER	HDSFHT, HDSF		
Basic Spec	Size	24	✓	✓		
	Side	L / R	✓	✓		
	Color - Single (use color sample from Regal)		✓	✓		
	Carbon Fiber Footplate		✓			
	Semi-Custom Made (p.7)	SCM	+	+		
Options: Aesthetics and Surface Enhancement	Color (p.14)	Dual Coloring Dorsal / Palmar (use color sample from Regal)	D/P	+	+	
		Custom Coloring (color sample is required)	CC	+	+	
	Nails, Hairs	X Series (p.16)	X	+	+	
		- Hair Dimension (available only when selecting X series)	2D / 3D	+	+	
		- Hair Color (available only when selecting X series) BB (Brown-Black), BR (Brown), BL (Black)	BB/BR /BL	+	+	
		Acrylic Nails (p.17)	ACRN	+	+	
	Smooth Coating	Smooth Coating (p.19)	SC	+	+	
Options: Structural Changes	Custom Filling (p.21)	- Foam	F	+	+	
		- Silicone	S	+	+	
		- Foam and Silicone	(available depends on the length of the residual limb p.21) F+S	+	+	
	Fingers Construction (p.23)	Wired Fingers	(with filling) (available depends on the size of Silicone Prostheses & the length of residual limb p.23)	W		
		Hinged Fingers		HF		
		Reinforced Fingers * fingers with RF may be larger in circumference * not available when selecting SCM option		RF		
		Fingers Bend (available only when selecting SCM) B1 (Straight), B2 (Standard) , B3 (Extra Bend)		B1/B2 /B3		
Zipper	Zipper (p.25) (plastic)	PZ	✓	✓		
	Glue To Socket (p.25) (prosthetic socket is required)	GTS				

How to order : See page 146

Please use the product codes from previous page.

Example:

HDSFHT - ER - L - 24 - 3 - SCM	-	ACRN - SC	-	S
Basic specification		Options: Aesthetics and Surface Enhancement		Options: Structural Changes

Measurements :

24cm

Model HDSFHT-ER (pg:104)	Thickness: Dorsal: 3.5mm	Plantar: 9.5mm	(mm)
Model HDSFHT (pg:104)	Thickness: Dorsal: 3.5mm	Plantar: 3.5mm	

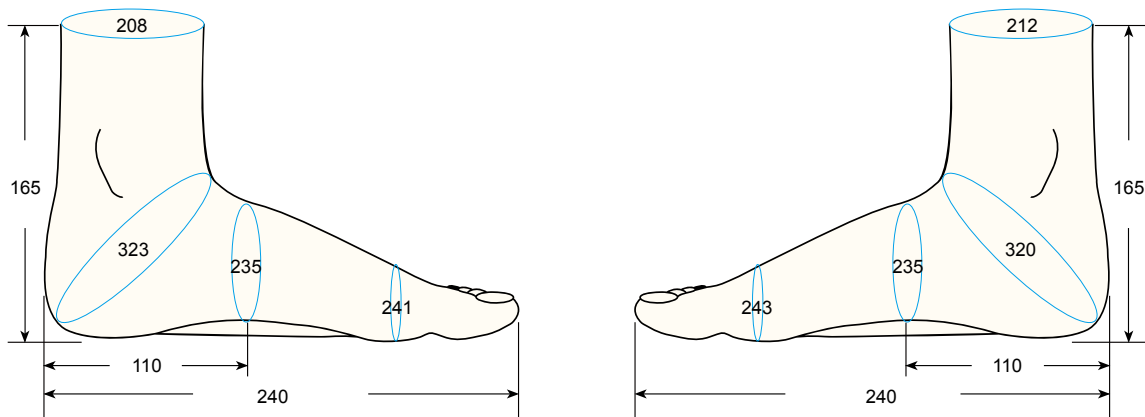

Model HDSF-ER (pg:105)	Thickness: Dorsal: 2.8mm	Plantar: 9.5mm	(mm)
Model HDSF (pg:105)	Thickness: Dorsal: 2.8mm	Plantar: 3.5mm	

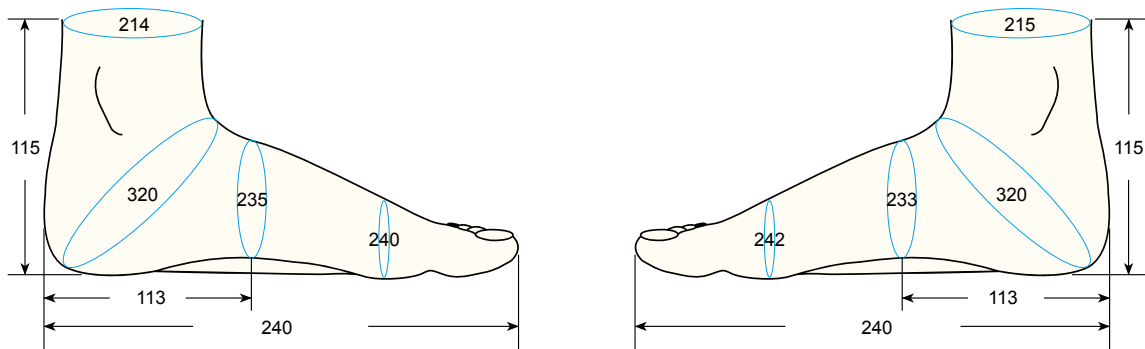

• All above information are for reference only •
• Please ask for more detail information •

Regal Silicone Prostheses

Upgrade Option

Myo-Electric & Mechanical Gloves

Gloves, Passive & Partial Hands, Digits

Footcovers

Leg / Arm Sleeve Maxillofacial / Accessories

FAQ & Warranty

Product: Silicone prosthetic footcover

Model: HDSFHT-ER, HDSF-ER (with carbon footplate)
HDSFHT, HDSF

Size: 23.5cm

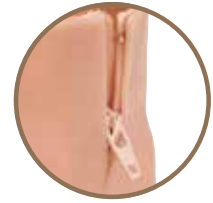

Plastic Zipper is integrated as standard feature

Carbon fiber energy restoring footplate

- ✓ = Standard feature
- O = Optional feature (no extra cost)
- + = Optional feature (extra cost)

Product Structure (List of all available features of each Model and Size)

Product features description			Code		Models		
			HDSFHT-ER, HDSF-ER	HDSFHT, HDSF			
Basic Spec	Size	23.5	✓	✓			
	Side	L / R	✓	✓			
	Color - Single (use color sample from Regal)		✓	✓			
	Carbon Fiber Footplate		✓				
	Semi-Custom Made (p.7)	SCM	+	+			
Options: Aesthetics and Surface Enhancement	Color (p.14)	Dual Coloring Dorsal / Palmar (use color sample from Regal)	D/P	+	+		
		Custom Coloring (color sample is required)	CC	+	+		
	Nails, Hairs	X Series (p.16)	X	+	+		
		- Hair Dimension (available only when selecting X series)	2D / 3D	+	+		
		- Hair Color (available only when selecting X series) BB (Brown-Black), BR (Brown), BL (Black)	BB/BR /BL	+	+		
		Acrylic Nails (p.17)	ACRN	+	+		
	Smooth Coating	Smooth Coating (p.19)	SC	+	+		
Options: Structural Changes	Custom Filling (p.21)	- Foam	F	+	+		
		- Silicone	S	+	+		
		- Foam and Silicone	(available depends on the length of the residual limb p.21) F+S	+	+		
	Fingers Construction (p.23)	Wired Fingers	(with filling) (available depends on the size of Silicone Prostheses & the length of residual limb p.23) W	W			
		Hinged Fingers	HF	HF			
		Reinforced Fingers * fingers with RF may be larger in circumference * not available when selecting SCM option	RF	RF			
Fingers Bend (available only when selecting SCM) B1 (Straight), B2 (Standard) , B3 (Extra Bend)	B1/B2 /B3	B1/B2 /B3					
Zipper	Zipper (p.25) (plastic)	PZ	✓	✓			
	Glue To Socket (p.25) (prosthetic socket is required)	GTS					

How to order : See page 146

Please use the product codes from previous page.

Example:

HDSFHT - ER - L - 23.5 - 3 - SCM	-	ACRN - SC	-	S
Basic specification		Options: Aesthetics and Surface Enhancement		Options: Structural Changes

Measurements :

23.5cm

Model HDSFHT-ER (pg:104)	Thickness: Dorsal: 3.5mm	Plantar: 9.5mm	(mm)
Model HDSFHT (pg:104)	Thickness: Dorsal: 3.5mm	Plantar: 3.5mm	

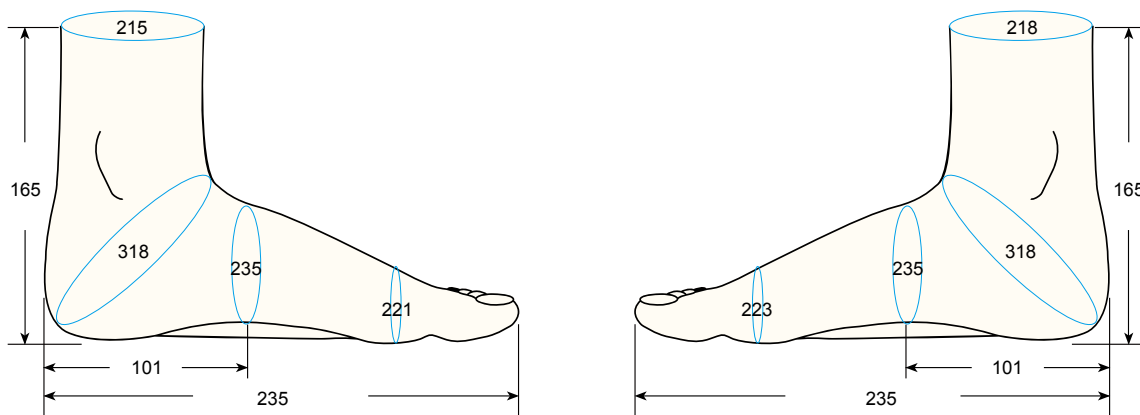

Model HDSF-ER (pg:105)	Thickness: Dorsal: 2.8mm	Plantar: 9.5mm	(mm)
Model HDSF (pg:105)	Thickness: Dorsal: 2.8mm	Plantar: 3.5mm	

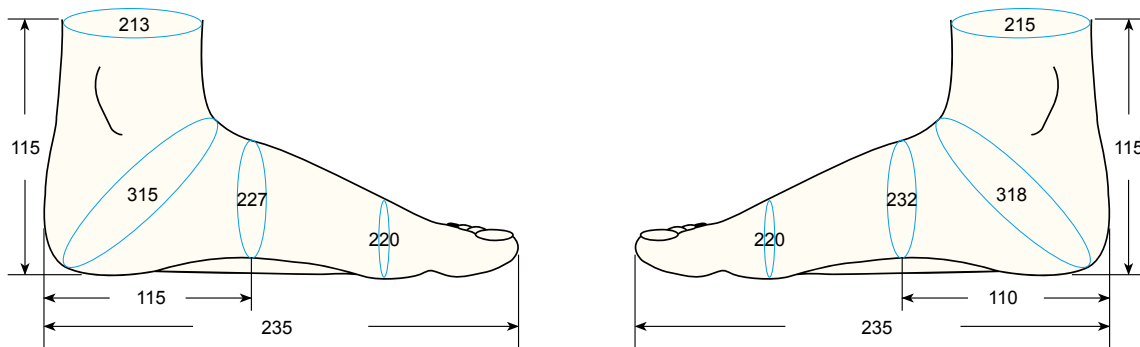

• All above information are for reference only •
• Please ask for more detail information •

Regal Silicone Prostheses

Product: Silicone prosthetic footcover

Model: HDSFHT-ER, HDSF-ER (with carbon footplate)
HDSFHT, HDSF

Size: 23cm

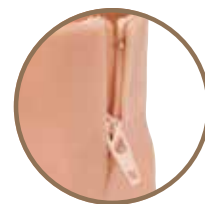

Plastic Zipper is integrated as standard feature

Carbon fiber energy restoring footplate

- ✓ = Standard feature
- O = Optional feature (no extra cost)
- + = Optional feature (extra cost)

Upgrade Option

Myo-Electric & Mechanical Gloves

Gloves, Passive & Partial Hands, Digits

Footcovers

Leg / Arm Sleeve Maxillofacial / Accessories

FAQ & Warranty

Product Structure (List of all available features of each Model and Size)

Models

Product features description			Code	HDSFHT-ER, HDSF-ER	HDSFHT, HDSF	
Basic Spec	Size		23	✓	✓	
	Side		L / R	✓	✓	
	Color - Single (use color sample from Regal)			✓	✓	
	Carbon Fiber Footplate			✓		
	Semi-Custom Made (p.7)		SCM	+	+	
Options: Aesthetics and Surface Enhancement	Color (p.14)	Dual Coloring Dorsal / Palmar (use color sample from Regal)	D/P	+	+	
		Custom Coloring (color sample is required)	CC	+	+	
	Nails, Hairs	X Series (p.16)		X	+	+
		- Hair Dimension (available only when selecting X series)		2D / 3D	+	+
		- Hair Color (available only when selecting X series)		BB/BR /BL	+	+
		BB (Brown-Black), BR (Brown), BL (Black)				
	Acrylic Nails (p.17)		ACRN	+	+	
Smooth Coating	Smooth Coating (p.19)		SC	+	+	
Options: Structural Changes	Custom Filling (p.21)	- Foam	F	+	+	
		- Silicone	S	+	+	
		- Foam and Silicone	(available depends on the length of the residual limb p.21)	F+S	+	+
	Fingers Construction (p.23)	Wired Fingers	(with filling)	(available depends on the size of Silicone Prostheses & the length of residual limb p.23)	W	
		Hinged Fingers			HF	
		Reinforced Fingers			RF	
		* fingers with RF may be larger in circumference * not available when selecting SCM option				
Fingers Bend (available only when selecting SCM)			B1/B2 /B3			
B1 (Straight), B2 (Standard) , B3 (Extra Bend)						
Zipper	Zipper (p.25) (plastic)		PZ	✓	✓	
	Glue To Socket (p.25) (prosthetic socket is required)		GTS			

How to order : See page 146

Please use the product codes from previous page.

Example:

HDSFHT - ER - L - 23 - 3 - SCM	-	ACRN - SC	-	S
Basic specification		Options: Aesthetics and Surface Enhancement		Options: Structural Changes

Measurements :

23cm

Model HDSFHT-ER (pg:104)	Thickness: Dorsal: 3.5mm	Plantar: 9.5mm	(mm)
Model HDSFHT (pg:104)	Thickness: Dorsal: 3.5mm	Plantar: 3.5mm	

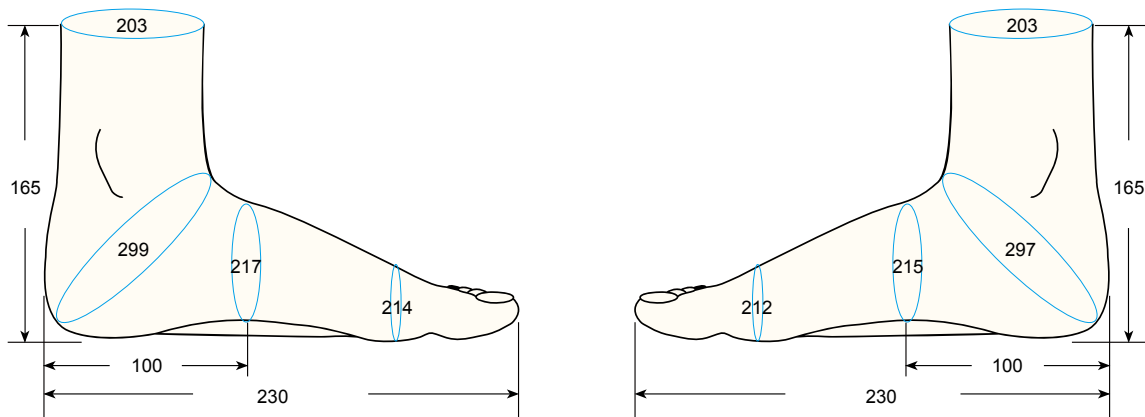

Model HDSF-ER (pg:105)	Thickness: Dorsal: 2.8mm	Plantar: 9.5mm	(mm)
Model HDSF (pg:105)	Thickness: Dorsal: 2.8mm	Plantar: 3.5mm	

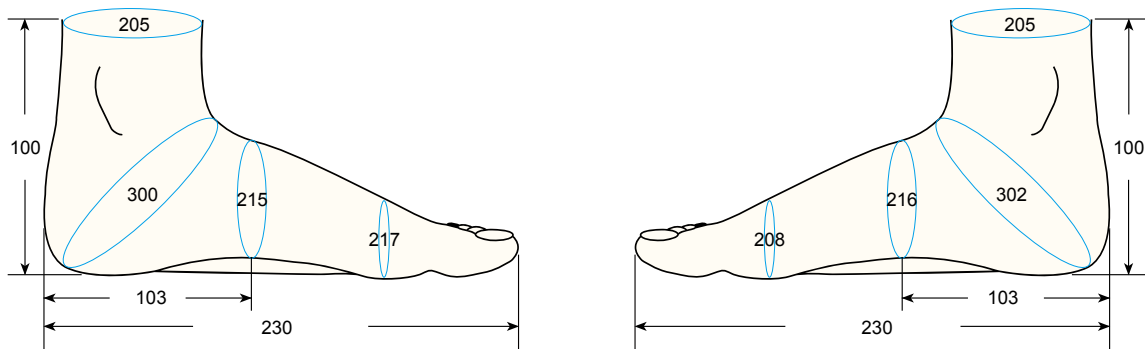

• All above information are for reference only •
• Please ask for more detail information •

Regal Silicone Prostheses

Product: Silicone prosthetic footcover

Model: HDSFHT-ER, HDSF-ER (with carbon footplate)
HDSFHT, HDSF

Size: 22cm

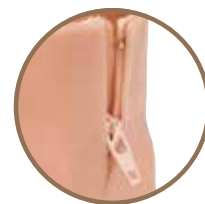

Plastic Zipper is integrated as standard feature

Carbon fiber energy restoring footplate

- ✓ = Standard feature
- O = Optional feature (no extra cost)
- + = Optional feature (extra cost)

Upgrade Option

Myo-Electric & Mechanical Gloves

Gloves, Passive & Partial Hands, Digits

Footcovers

Leg / Arm Sleeve Maxillofacial / Accessories

FAQ & Warranty

Product Structure (List of all available features of each Model and Size)

Models

Product features description			Code	HDSFHT-ER, HDSF-ER	HDSFHT, HDSF	
Basic Spec	Size	22		✓	✓	
	Side	L / R		✓	✓	
	Color - Single (use color sample from Regal)			✓	✓	
	Carbon Fiber Footplate			✓		
	Semi-Custom Made (p.7)	SCM		+	+	
Options: Aesthetics and Surface Enhancement	Color (p.14)	Dual Coloring Dorsal / Palmar (use color sample from Regal)	D/P	+	+	
		Custom Coloring (color sample is required)	CC	+	+	
	Nails, Hairs	X Series (p.16)	X	+	+	
		- Hair Dimension (available only when selecting X series)	2D / 3D	+	+	
		- Hair Color (available only when selecting X series) BB (Brown-Black), BR (Brown), BL (Black)	BB/BR /BL	+	+	
		Acrylic Nails (p.17)	ACRN	+	+	
	Smooth Coating	Smooth Coating (p.19)	SC	+	+	
Options: Structural Changes	Custom Filling (p.21)	- Foam	F	+	+	
		- Silicone	S	+	+	
		- Foam and Silicone	(available depends on the length of the residual limb p.21) F+S	+	+	
	Fingers Construction (p.23)	Wired Fingers	(with filling) (available depends on the size of Silicone Prostheses & the length of residual limb p.23)	W		
		Hinged Fingers		HF		
		Reinforced Fingers * fingers with RF may be larger in circumference * not available when selecting SCM option		RF		
		Fingers Bend (available only when selecting SCM) B1 (Straight), B2 (Standard) , B3 (Extra Bend)		B1/B2 /B3		
Zipper	Zipper (p.25) (plastic)	PZ	✓	✓		
	Glue To Socket (p.25) (prosthetic socket is required)	GTS				

How to order : See page 146

Please use the product codes from previous page.

Example:

HDSFHT - ER - L - 22 - 3 - SCM	-	ACRN - SC	-	S
Basic specification		Options: Aesthetics and Surface Enhancement		Options: Structural Changes

Measurements :

22cm

Model HDSFHT-ER (pg:104)	Thickness: Dorsal: 3.5mm	Plantar: 9.5mm	(mm)
Model HDSFHT (pg:104)	Thickness: Dorsal: 3.5mm	Plantar: 3.5mm	

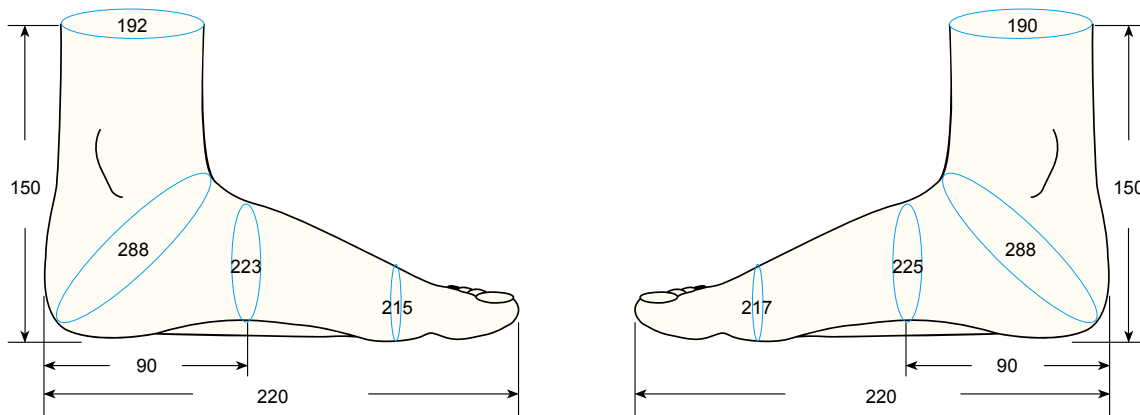

Model HDSF-ER (pg:105)	Thickness: Dorsal: 2.8mm	Plantar: 9.5mm	(mm)
Model HDSF (pg:105)	Thickness: Dorsal: 2.8mm	Plantar: 3.5mm	

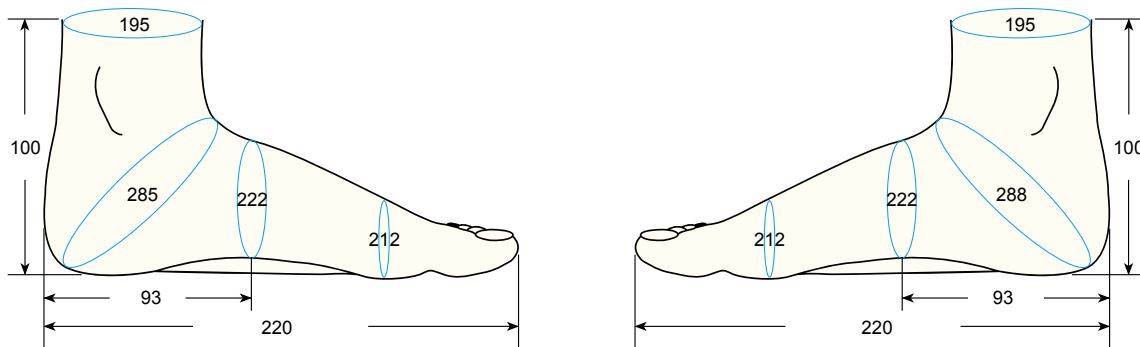

• All above information are for reference only •
• Please ask for more detail information •

Regal Silicone Prostheses

Product: Silicone prosthetic footcover

Model: HDSFHT-ER, HDSF-ER (with carbon footplate)
HDSFHT, HDSF

Size: 21cm

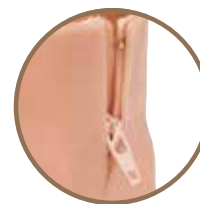

Plastic Zipper is integrated as standard feature

Carbon fiber energy restoring footplate

- ✓ = Standard feature
- O = Optional feature (no extra cost)
- + = Optional feature (extra cost)

Upgrade Option

Myo-Electric & Mechanical Gloves

Gloves, Passive & Partial Hands, Digits

Footcovers

Leg / Arm Sleeve
Maxillofacial / Accessories

FAQ & Warranty

Product Structure (List of all available features of each Model and Size)

Product features description			Models		
		Code	HDSFHT-ER, HDSF-ER	HDSFHT, HDSF	
Basic Spec	Size	21	✓	✓	
	Side	L / R	✓	✓	
	Color - Single (use color sample from Regal)		✓	✓	
	Carbon Fiber Footplate		✓		
	Semi-Custom Made (p.7)	SCM	+	+	
Options: Aesthetics and Surface Enhancement	Color (p.14)	Dual Coloring Dorsal / Palmar (use color sample from Regal)	D/P	+	+
		Custom Coloring (color sample is required)	CC	+	+
	Nails, Hairs	X Series (p.16)	X	+	+
		- Hair Dimension (available only when selecting X series)	2D / 3D	+	+
		- Hair Color (available only when selecting X series) BB (Brown-Black), BR (Brown), BL (Black)	BB/BR /BL	+	+
		Acrylic Nails (p.17)	ACRN	+	+
	Smooth Coating	Smooth Coating (p.19)	SC	+	+
Options: Structural Changes	Custom Filling (p.21)	- Foam	F	+	+
		- Silicone	S	+	+
		- Foam and Silicone	(available depends on the length of the residual limb p.21) F+S	+	+
	Fingers Construction (p.23)	Wired Fingers	(with filling) (available depends on the size of Silicone Prostheses & the length of residual limb p.23) W		
		Hinged Fingers	HF		
		Reinforced Fingers * fingers with RF may be larger in circumference * not available when selecting SCM option	RF		
	Fingers Bend (available only when selecting SCM) B1 (Straight), B2 (Standard) , B3 (Extra Bend)	B1/B2 /B3			
Zipper	Zipper (p.25) (plastic)	PZ	✓	✓	
	Glue To Socket (p.25) (prosthetic socket is required)	GTS			

How to order : See page 146

Please use the product codes from previous page.

Example:

HDSFHT - ER - L - 21 - 3 - SCM	-	ACRN - SC	-	S
Basic specification		Options: Aesthetics and Surface Enhancement		Options: Structural Changes

Measurements :

21cm

Model HDSFHT-ER (pg:104)	Thickness: Dorsal: 3.5mm	Plantar: 9.5mm	(mm)
Model HDSFHT (pg:104)	Thickness: Dorsal: 3.5mm	Plantar: 3.5mm	

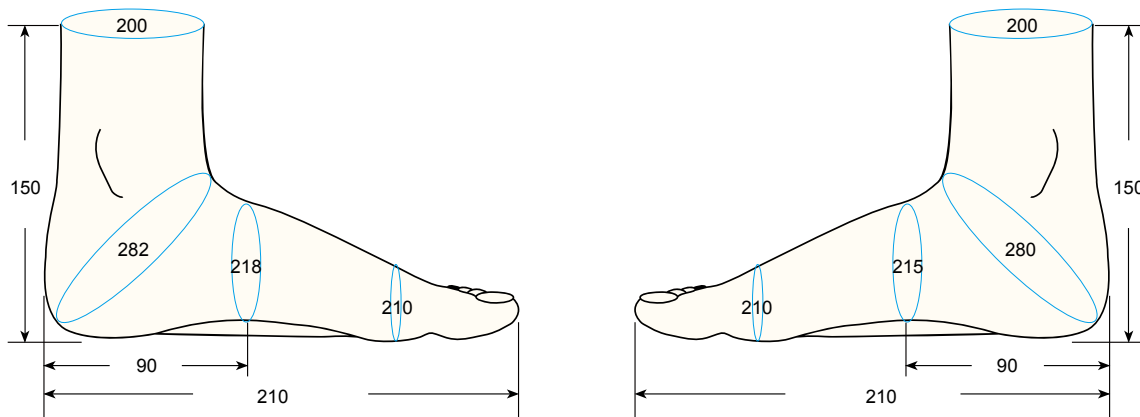

Model HDSF-ER (pg:105)	Thickness: Dorsal: 2.8mm	Plantar: 9.5mm	(mm)
Model HDSF (pg:105)	Thickness: Dorsal: 2.8mm	Plantar: 3.5mm	

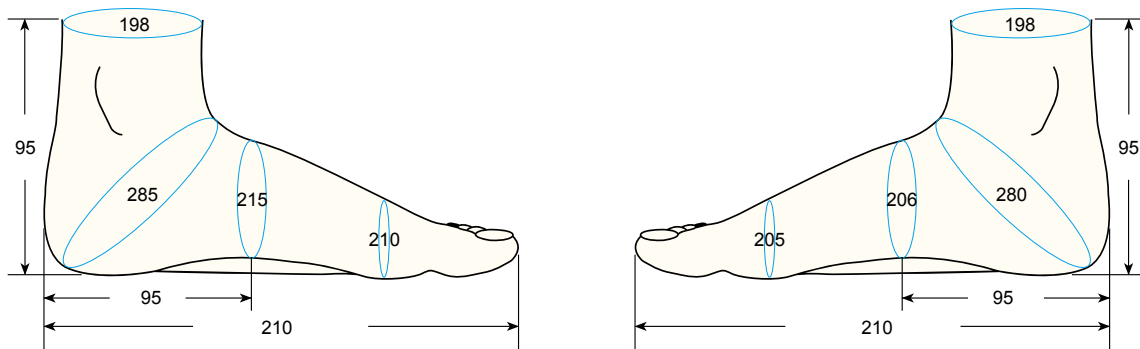

• All above information are for reference only •
• Please ask for more detail information •

Regal Silicone Prostheses

Upgrade Option

Myo-Electric & Mechanical Gloves

Gloves, Passive & Partial Hands, Digits

Footcovers

Leg / Arm Sleeve Maxillofacial / Accessories

FAQ & Warranty

Product: Silicone prosthetic footcover

Model: HDSFHT-ER, HDSF-ER (with carbon footplate)
HDSFHT, HDSF

Size: 20cm

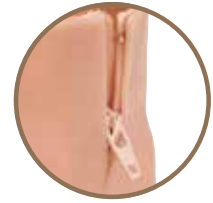

Plastic Zipper is integrated as standard feature

Carbon fiber energy restoring footplate

- ✓ = Standard feature
- O = Optional feature (no extra cost)
- + = Optional feature (extra cost)

Product Structure (List of all available features of each Model and Size)

Product features description			Code		Models		
			HDSFHT-ER, HDSF-ER	HDSFHT, HDSF			
Basic Spec	Size	20	✓	✓			
	Side	L / R	✓	✓			
	Color - Single (use color sample from Regal)		✓	✓			
	Carbon Fiber Footplate		✓				
	Semi-Custom Made (p.7)	SCM	+	+			
Options: Aesthetics and Surface Enhancement	Color (p.14)	Dual Coloring Dorsal / Palmar (use color sample from Regal)	D/P	+	+		
		Custom Coloring (color sample is required)	CC	+	+		
	Nails, Hairs	X Series (p.16)	X	+	+		
		- Hair Dimension (available only when selecting X series)	2D / 3D	+	+		
		- Hair Color (available only when selecting X series) BB (Brown-Black), BR (Brown), BL (Black)	BB/BR /BL	+	+		
		Acrylic Nails (p.17)	ACRN	+	+		
	Smooth Coating	Smooth Coating (p.19)	SC	+	+		
Options: Structural Changes	Custom Filling (p.21)	- Foam	F	+	+		
		- Silicone	S	+	+		
		- Foam and Silicone	(available depends on the length of the residual limb p.21) F+S	+	+		
	Fingers Construction (p.23)	Wired Fingers	(with filling) (available depends on the size of Silicone Prostheses & the length of residual limb p.23)	W			
		Hinged Fingers		HF			
		Reinforced Fingers	* fingers with RF may be larger in circumference * not available when selecting SCM option	RF			
		Fingers Bend (available only when selecting SCM) B1 (Straight), B2 (Standard) , B3 (Extra Bend)		B1/B2 /B3			
Zipper	Zipper (p.23) (plastic)	PZ	✓	✓			
	Glue To Socket (p.23) (prosthetic socket is required)	GTS					

How to order : See page 146

Please use the product codes from previous page.

Example:

HDSFHT - ER - L - 20 - 3 - SCM	-	ACRN - SC	-	S
Basic specification		Options: Aesthetics and Surface Enhancement		Options: Structural Changes

Measurements :

20cm

Model HDSFHT-ER (pg:104)	Thickness: Dorsal: 3.5mm	Plantar: 9.5mm	(mm)
Model HDSFHT (pg:104)	Thickness: Dorsal: 3.5mm	Plantar: 3.5mm	

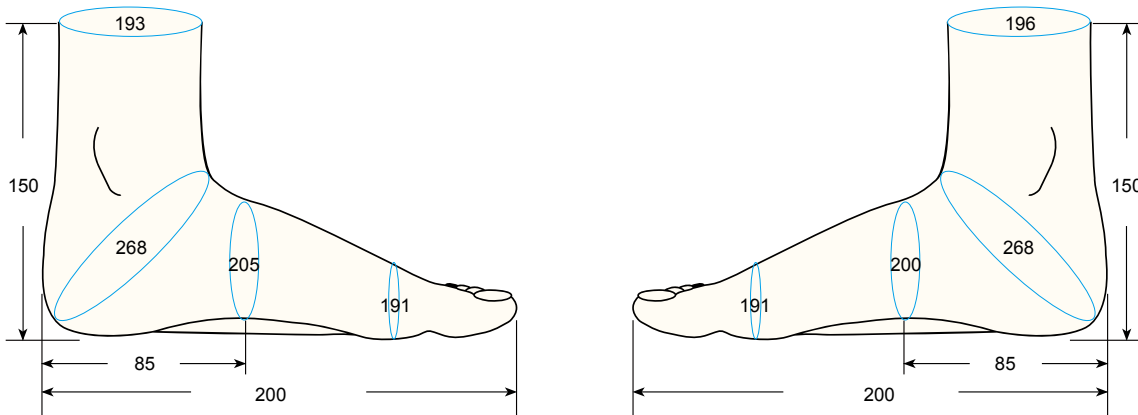

Model HDSF-ER (pg:105)	Thickness: Dorsal: 2.8mm	Plantar: 9.5mm	(mm)
Model HDSF (pg:105)	Thickness: Dorsal: 2.8mm	Plantar: 3.5mm	

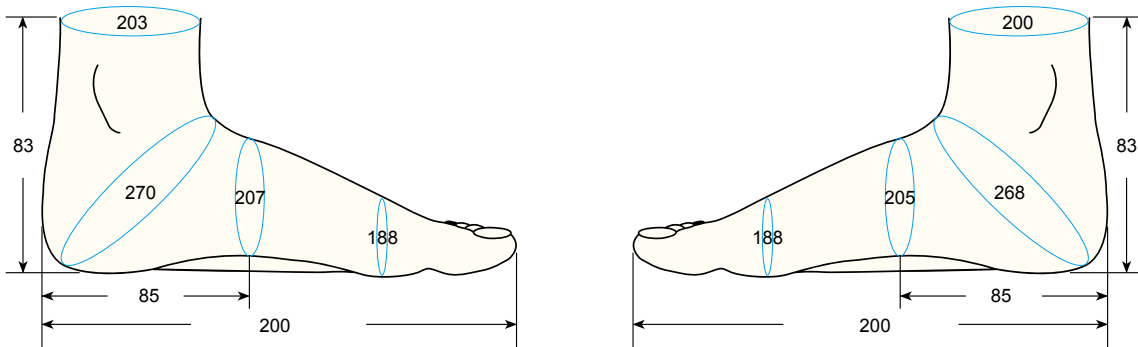

• All above information are for reference only •
• Please ask for more detail information •

Regal Silicone Prostheses

Upgrade Option

Myo-Electric & Mechanical Gloves

Gloves, Passive & Partial Hands, Digits

Footcovers

Leg / Arm Sleeve Maxillofacial / Accessories

FAQ & Warranty

Product: Silicone prosthetic footcover

Model: HDSFHT-ER, HDSF-ER (with carbon footplate)
HDSFHT, HDSF

Size: 19cm

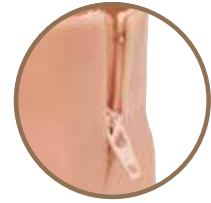

Plastic Zipper is integrated as standard feature

Carbon fiber energy restoring footplate

- ✓ = Standard feature
- O = Optional feature (no extra cost)
- + = Optional feature (extra cost)

Product Structure (List of all available features of each Model and Size)

Product features description			Models			
			HDSFHT-ER, HDSF-ER	HDSFHT, HDSF		
Basic Spec	Size	19	✓	✓		
	Side	L / R	✓	✓		
	Color - Single (use color sample from Regal)		✓	✓		
	Carbon Fiber Footplate		✓			
	Semi-Custom Made (p.7)	SCM	+	+		
Options: Aesthetics and Surface Enhancement	Color (p.14)	Dual Coloring Dorsal / Palmar (use color sample from Regal)	D/P	+	+	
		Custom Coloring (color sample is required)	CC	+	+	
	Nails, Hairs	X Series (p.16)	X	+	+	
		- Hair Dimension (available only when selecting X series)	2D / 3D	+	+	
		- Hair Color (available only when selecting X series) BB (Brown-Black), BR (Brown), BL (Black)	BB/BR /BL	+	+	
		Acrylic Nails (p.17)	ACRN	+	+	
	Smooth Coating	Smooth Coating (p.19)	SC	+	+	
Options: Structural Changes	Custom Filling (p.21)	- Foam	F	+	+	
		- Silicone	S	+	+	
		- Foam and Silicone	(available depends on the length of the residual limb p.21) F+S	+	+	
	Fingers Construction (p.23)	Wired Fingers	(with filling) (available depends on the size of Silicone Prostheses & the length of residual limb p.23)	W		
		Hinged Fingers		HF		
		Reinforced Fingers * fingers with RF may be larger in circumference * not available when selecting SCM option		RF		
	Fingers Bend (available only when selecting SCM) B1 (Straight), B2 (Standard), B3 (Extra Bend)		B1/B2 /B3			
Zipper	Zipper (p.25) (plastic)		PZ	✓	✓	
	Glue To Socket (p.25) (prosthetic socket is required)		GTS			

How to order : See page 146

Please use the product codes from previous page.

Example:

HDSFHT - ER - L - 19 - 3 - SCM	-	ACRN - SC	-	S
Basic specification		Options: Aesthetics and Surface Enhancement		Options: Structural Changes

Measurements :

19cm

Model HDSFHT-ER (pg:104)	Thickness: Dorsal: 3.5mm	Plantar: 9.5mm	(mm)
Model HDSFHT (pg:104)	Thickness: Dorsal: 3.5mm	Plantar: 3.5mm	

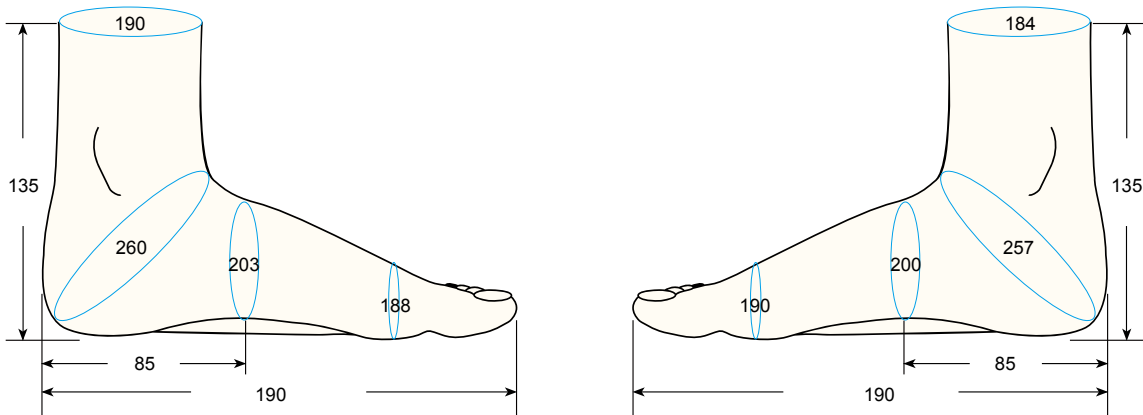

Model HDSF-ER (pg:105)	Thickness: Dorsal: 2.8mm	Plantar: 9.5mm	(mm)
Model HDSF (pg:105)	Thickness: Dorsal: 2.8mm	Plantar: 3.5mm	

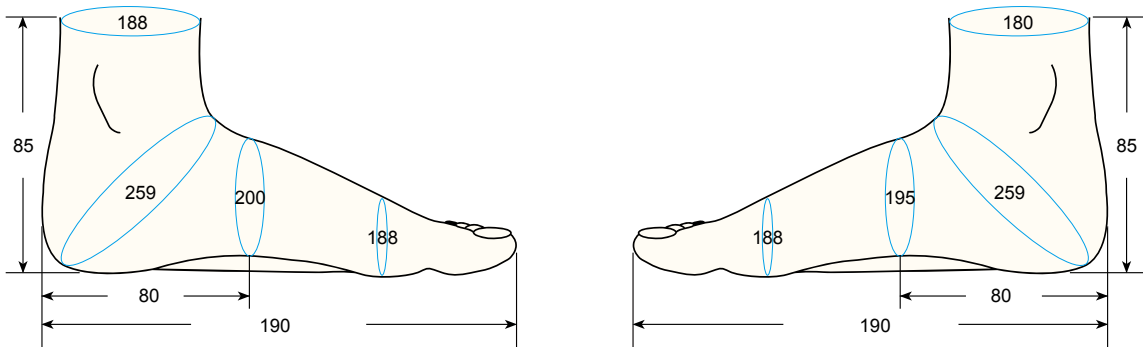

• All above information are for reference only •
• Please ask for more detail information •

Regal Silicone Prostheses

Upgrade Option

Myo-Electric & Mechanical Gloves

Gloves, Passive & Partial Hands, Digits

Footcovers

Leg / Arm Sleeve Maxillofacial / Accessories

FAQ & Warranty

Product: Silicone prosthetic footcover

Model: HDSFHT-ER, HDSF-ER (with carbon footplate)
HDSFHT, HDSF

Size: 18cm

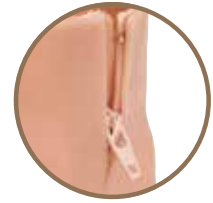

Plastic Zipper is integrated as standard feature

Carbon fiber energy restoring footplate

- ✓ = Standard feature
- O = Optional feature (no extra cost)
- + = Optional feature (extra cost)

Product Structure (List of all available features of each Model and Size)

Product features description			Models			
		Code	HDSFHT-ER, HDSF-ER	HDSFHT, HDSF		
Basic Spec	Size	18	✓	✓		
	Side	L / R	✓	✓		
	Color - Single (use color sample from Regal)		✓	✓		
	Carbon Fiber Footplate		✓			
	Semi-Custom Made (p.7)	SCM	+	+		
Options: Aesthetics and Surface Enhancement	Color (p.14)	Dual Coloring Dorsal / Palmar (use color sample from Regal)	D/P	+	+	
		Custom Coloring (color sample is required)	CC	+	+	
	Nails, Hairs	X Series (p.16)	X	+	+	
		- Hair Dimension (available only when selecting X series)	2D / 3D	+	+	
		- Hair Color (available only when selecting X series) BB (Brown-Black), BR (Brown), BL (Black)	BB/BR /BL	+	+	
		Acrylic Nails (p.17)	ACRN	+	+	
	Smooth Coating	Smooth Coating (p.19)	SC	+	+	
Options: Structural Changes	Custom Filling (p.21)	- Foam	F	+	+	
		- Silicone	S	+	+	
		- Foam and Silicone	(available depends on the length of the residual limb p.21) F+S	+	+	
	Fingers Construction (p.23)	Wired Fingers	(with filling) (available depends on the size of Silicone Prostheses & the length of residual limb p.23)	W		
		Hinged Fingers		HF		
		Reinforced Fingers * fingers with RF may be larger in circumference * not available when selecting SCM option		RF		
		Fingers Bend (available only when selecting SCM) B1 (Straight), B2 (Standard) , B3 (Extra Bend)		B1/B2 /B3		
Zipper	Zipper (p.25) (plastic)	PZ	✓	✓		
	Glue To Socket (p.25) (prosthetic socket is required)	GTS				

How to order : See page 146

Please use the product codes from previous page.

Example:

HDSFHT - ER - L - 18 - 3 - SCM	-	ACRN - SC	-	S
Basic specification		Options: Aesthetics and Surface Enhancement		Options: Structural Changes

Measurements :

18cm

Model HDSFHT-ER (pg:104)	Thickness: Dorsal: 3.5mm	Plantar: 9.5mm	(mm)
Model HDSFHT (pg:104)	Thickness: Dorsal: 3.5mm	Plantar: 3.5mm	

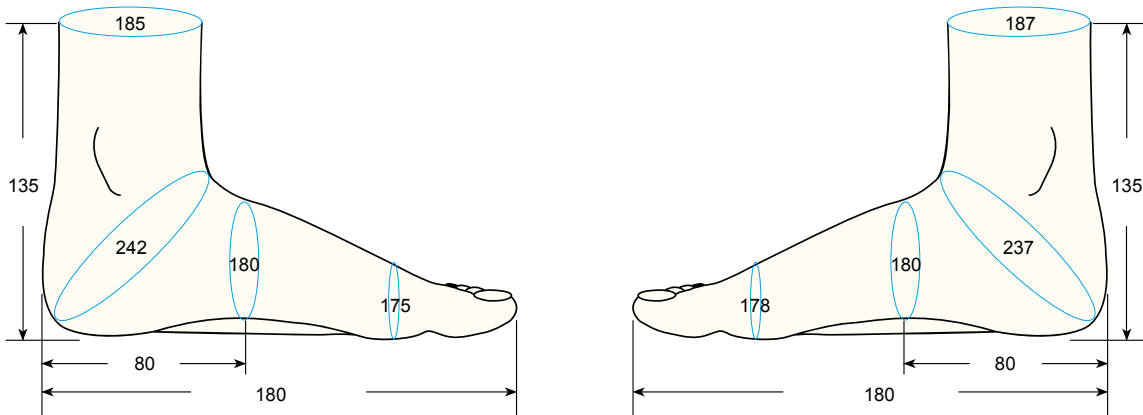

Model HDSF-ER (pg:105)	Thickness: Dorsal: 2.8mm	Plantar: 9.5mm	(mm)
Model HDSF (pg:105)	Thickness: Dorsal: 2.8mm	Plantar: 3.5mm	

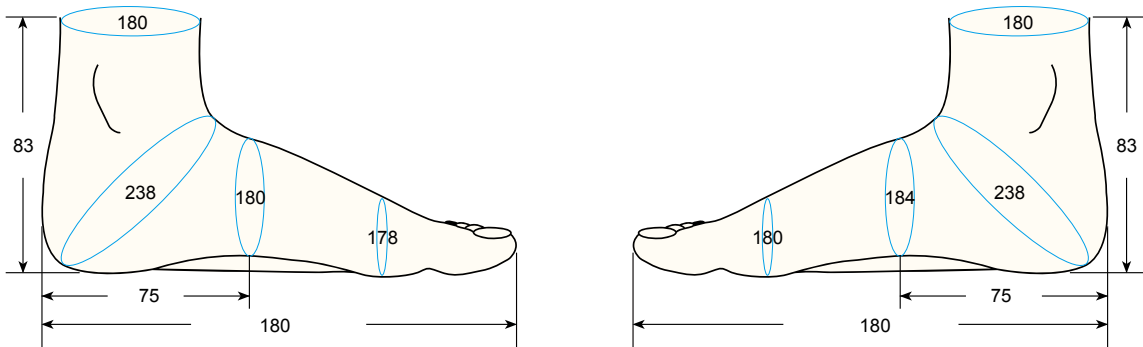

• All above information are for reference only •
• Please ask for more detail information •

Regal Silicone Prostheses

Upgrade Option

Myo-Electric & Mechanical Gloves

Gloves, Passive & Partial Hands, Digits

Footcovers

Leg / Arm Sleeve Maxillofacial / Accessories

FAQ & Warranty

Product: Silicone prosthetic footcover

Model: HDSFHT-ER (with carbon footplate)
HDSFHT

Size: 17cm

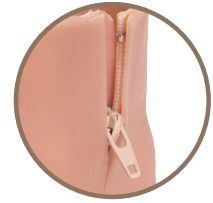

Plastic Zipper is integrated as standard feature

Carbon fiber energy restoring footplate

- ✓ = Standard feature
- O = Optional feature (no extra cost)
- + = Optional feature (extra cost)

Product Structure (List of all available features of each Model and Size)

Product features description				Models		
Product features description				HDSFHT-ER	HDSFHT	
Basic Spec	Size	17		✓	✓	
	Side	L / R		✓	✓	
	Color - Single (use color sample from Regal)			✓	✓	
	Carbon Fiber Footplate			✓		
	Semi-Custom Made (p.7)	SCM		+	+	
Options: Aesthetics and Surface Enhancement	Color (p.14)	Dual Coloring Dorsal / Palmar (use color sample from Regal)	D/P	+	+	
		Custom Coloring (color sample is required)	CC	+	+	
	Nails, Hairs	X Series (p.16)	X	+	+	
		- Hair Dimension (available only when selecting X series)	2D / 3D	+	+	
		- Hair Color (available only when selecting X series) BB (Brown-Black), BR (Brown), BL (Black)	BB/BR /BL	+	+	
		Acrylic Nails (p.17)	ACRN	+	+	
	Smooth Coating	Smooth Coating (p.19)	SC	+	+	
Options: Structural Changes	Custom Filling (p.21)	- Foam	F	+	+	
		- Silicone	S	+	+	
		- Foam and Silicone (available depends on the length of the residual limb p.21)	F+S	+	+	
	Fingers Construction (p.23)	Wired Fingers	(with filling) (available depends on the size of Silicone Prostheses & the length of residual limb p.23)	W		
		Hinged Fingers		HF		
		Reinforced Fingers * fingers with RF may be larger in circumference * not available when selecting SCM option		RF		
		Fingers Bend (available only when selecting SCM) B1 (Straight), B2 (Standard), B3 (Extra Bend)		B1/B2 /B3		
	Zipper	Zipper (p.25) (plastic)	PZ	✓	✓	
	Glue To Socket (p.25) (prosthetic socket is required)	GTS				

How to order : See page 148

Please use the product codes from previous page.

Example:

HDSFHT - ER - L - 17 - 3 - SCM	-	ACRN - SC	-	S
Basic specification		Options: Aesthetics and Surface Enhancement		Options: Structural Changes

Measurements :

17cm

Model HDSFHT-ER (pg:104)	Thickness: Dorsal: 3.5mm	Plantar: 9.5mm	(mm)
Model HDSFHT (pg:104)	Thickness: Dorsal: 3.5mm	Plantar: 3.5mm	

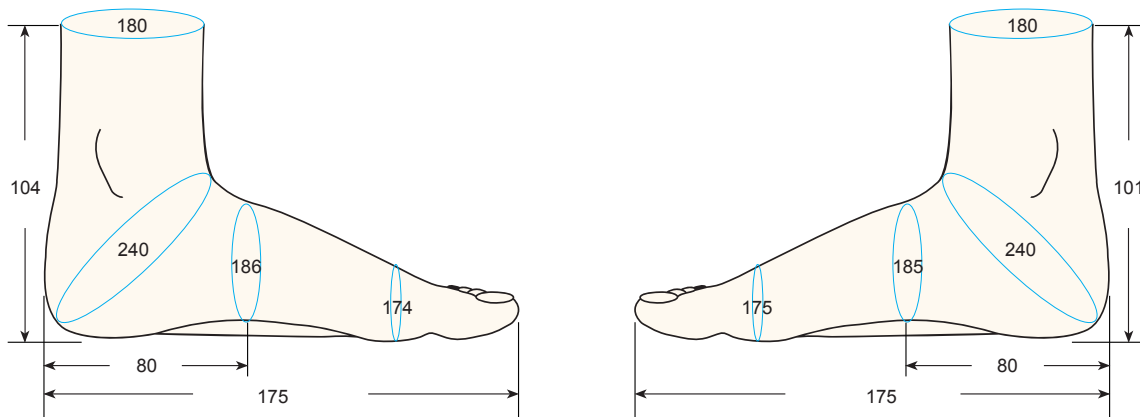

Upgrade Option

Myo-Electric & Mechanical Gloves

Gloves, Passive & Partial Hands, Digits

Footcovers

Leg / Arm Sleeve
Maxillofacial / Accessories

FAQ & Warranty

• All above information are for reference only •
• Please ask for more detail information •

Regal Silicone Prostheses

Upgrade Option

Myo-Electric & Mechanical Gloves

Gloves, Passive & Partial Hands, Digits

Footcovers

Leg / Arm Sleeve Maxillofacial / Accessories

FAQ & Warranty

Product: Silicone prosthetic footcover

Model: HDSFHT-ER (with carbon footplate)
HDSFHT

Size: 16.5cm



Plastic Zipper is integrated as standard feature

Carbon fiber energy restoring footplate

✓ = Standard feature
O = Optional feature (no extra cost)
+ = Optional feature (extra cost)

Product Structure (List of all available features of each Model and Size)

Product features description				Models			
Code				HDSFHT-ER	HDSFHT		
Basic Spec	Size		16.5	✓	✓		
	Side		L / R	✓	✓		
	Color - Single (use color sample from Regal)			✓	✓		
	Carbon Fiber Footplate			✓			
Options: Aesthetics and Surface Enhancement	Semi-Custom Made (p.7)		SCM	+	+		
	Color (p.14)	Dual Coloring Dorsal / Palmar (use color sample from Regal)	D/P	+	+		
		Custom Coloring (color sample is required)	CC	+	+		
	Nails, Hairs	X Series (p.16)		X	+	+	
		- Hair Dimension (available only when selecting X series)	2D / 3D		+	+	
		- Hair Color (available only when selecting X series) BB (Brown-Black), BR (Brown), BL (Black)	BB/BR /BL		+	+	
		Acrylic Nails (p.17)		ACRN	+	+	
	Smooth Coating	Smooth Coating (p.19)		SC	+	+	
Options: Structural Changes	Custom Filling (p.21)	- Foam		F	+	+	
		- Silicone		S	+	+	
		- Foam and Silicone	(available depends on the length of the residual limb p.21)	F+S	+	+	
	Fingers Construction (p.23)	Wired Fingers	(with filling)	(available depends on the size of Silicone Prostheses & the length of residual limb p.23)	W		
		Hinged Fingers			HF		
		Reinforced Fingers * fingers with RF may be larger in circumference * not available when selecting SCM option			RF		
		Fingers Bend (available only when selecting SCM) B1 (Straight), B2 (Standard), B3 (Extra Bend)			B1/B2 /B3		
	Zipper	Zipper (p.25) (plastic)		PZ	✓	✓	
	Glue To Socket (p.25) (prosthetic socket is required)		GTS				

How to order : See page 148

Please use the product codes from previous page.

Example:

HDSFHT - ER - L - 16.5 - 3 - SCM	-	ACRN - SC	-	S
----------------------------------	---	-----------	---	---

Basic specification

Options:
Aesthetics and Surface Enhancement

Options:
Structural Changes

Measurements :

16.5cm

Model HDSFHT-ER (pg:104)	Thickness: Dorsal: 3.5mm	Plantar: 9.5mm	
Model HDSFHT (pg:104)	Thickness: Dorsal: 3.5mm	Plantar: 3.5mm	(mm)

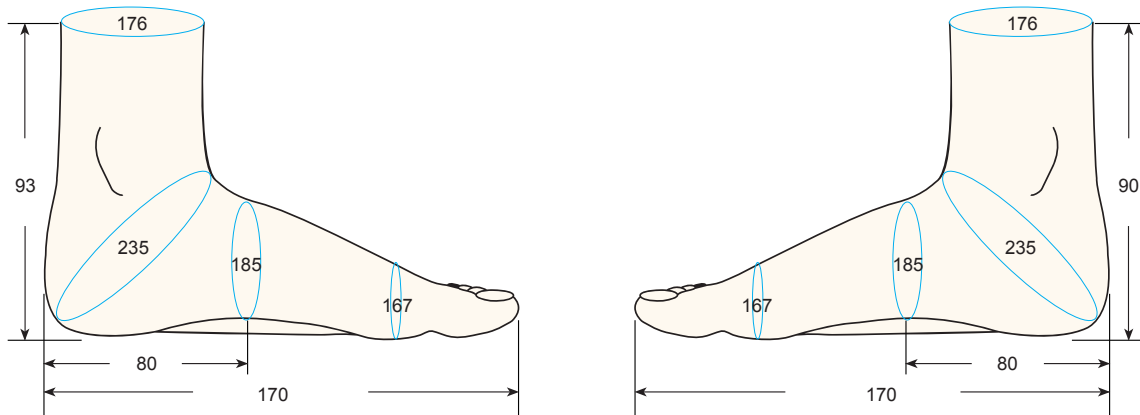

Upgrade Option

Myo-Electric & Mechanical Gloves

Gloves, Passive & Partial Hands, Digits

Footcovers

Leg / Arm Sleeve
Maxillofacial / Accessories

FAQ & Warranty

• All above information are for reference only •
• Please ask for more detail information •

Regal Silicone Prostheses

Upgrade Option

Myo-Electric & Mechanical Gloves

Gloves, Passive & Partial Hands, Digits

Footcovers

Leg / Arm Sleeve Maxillofacial / Accessories

FAQ & Warranty

Product: Silicone prosthetic footcover

Model: HDSFHT-ER (with carbon footplate)
HDSFHT

Size: 16cm

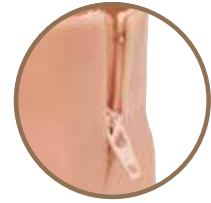

Plastic Zipper is integrated as standard feature

Carbon fiber energy restoring footplate

- ✓ = Standard feature
- O = Optional feature (no extra cost)
- + = Optional feature (extra cost)

Product Structure (List of all available features of each Model and Size)

Product features description			Code		Models		
			HDSFHT-ER	HDSFHT			
Basic Spec	Size	16	✓	✓			
	Side	L / R	✓	✓			
	Color - Single (use color sample from Regal)		✓	✓			
	Carbon Fiber Footplate		✓				
	Semi-Custom Made (p.7)	SCM	+	+			
Options: Aesthetics and Surface Enhancement	Color (p.14)	Dual Coloring Dorsal / Palmar (use color sample from Regal)	D/P	+	+		
		Custom Coloring (color sample is required)	CC	+	+		
	Nails, Hairs	X Series (p.16)	X	+	+		
		- Hair Dimension (available only when selecting X series)	2D / 3D	+	+		
		- Hair Color (available only when selecting X series) BB (Brown-Black), BR (Brown), BL (Black)	BB/BR /BL	+	+		
		Acrylic Nails (p.17)	ACRN	+	+		
	Smooth Coating	Smooth Coating (p.19)	SC	+	+		
Options: Structural Changes	Custom Filling (p.21)	- Foam	F	+	+		
		- Silicone	S	+	+		
		- Foam and Silicone	(available depends on the length of the residual limb p.21) F+S	+	+		
	Fingers Construction (p.23)	Wired Fingers	(with filling) (available depends on the size of Silicone Prostheses & the length of residual limb p.23)	W			
		Hinged Fingers		HF			
		Reinforced Fingers * fingers with RF may be larger in circumference * not available when selecting SCM option		RF			
	Fingers Bend (available only when selecting SCM) B1 (Straight), B2 (Standard), B3 (Extra Bend)		B1/B2 /B3				
Zipper	Zipper (p.25) (plastic)		PZ	✓	✓		
	Glue To Socket (p.25) (prosthetic socket is required)		GTS				

How to order : See page 146

Please use the product codes from previous page.

Example:

HDSFHT - ER - L - 16 - 3 - SCM	-	ACRN - SC	-	S
Basic specification		Options: Aesthetics and Surface Enhancement		Options: Structural Changes

Measurements :

16cm

Model HDSFHT-ER (pg:104)	Thickness: Dorsal: 3.5mm	Plantar: 9.5mm	(mm)
Model HDSFHT (pg:104)	Thickness: Dorsal: 3.5mm	Plantar: 3.5mm	

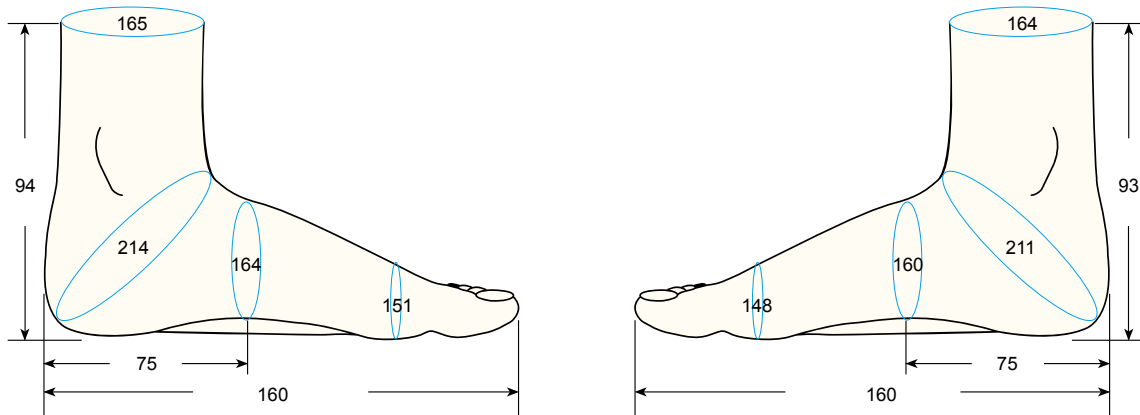

Upgrade Option

Myo-Electric & Mechanical Gloves

Gloves, Passive & Partial Hands, Digits

Footcovers

Leg / Arm Sleeve
Maxillofacial / Accessories

FAQ & Warranty

• All above information are for reference only •
• Please ask for more detail information •

Regal Silicone Prostheses

Upgrade Option

Myo-Electric & Mechanical Gloves

Gloves, Passive & Partial Hands, Digits

Footcovers

Leg / Arm Sleeve Maxillofacial / Accessories

FAQ & Warranty

Product: Silicone prosthetic footcover

Model: HDSFHT-ER (with carbon footplate)
HDSFHT

Size: 15cm

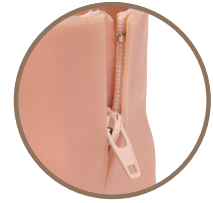

Plastic Zipper is integrated as standard feature

Carbon fiber energy restoring footplate

- ✓ = Standard feature
- O = Optional feature (no extra cost)
- + = Optional feature (extra cost)

Product Structure (List of all available features of each Model and Size)

Product features description				Models			
Code				HDSFHT-ER	HDSFHT		
Basic Spec	Size		15	✓	✓		
	Side		L / R	✓	✓		
	Color - Single (use color sample from Regal)			✓	✓		
	Carbon Fiber Footplate			✓			
Options: Aesthetics and Surface Enhancement	Semi-Custom Made (p.7)		SCM	+	+		
	Color (p.14)	Dual Coloring Dorsal / Palmar (use color sample from Regal)	D/P	+	+		
		Custom Coloring (color sample is required)	CC	+	+		
	Nails, Hairs	X Series (p.16)		X	+	+	
		- Hair Dimension (available only when selecting X series)	2D / 3D		+	+	
		- Hair Color (available only when selecting X series)	BB/BR /BL		+	+	
		BB (Brown-Black), BR (Brown), BL (Black)					
	Acrylic Nails (p.17)		ACRN				
Smooth Coating	Smooth Coating (p.19)		SC	+	+		
Options: Structural Changes	Custom Filling (p.21)	- Foam		F	+	+	
		- Silicone		S	+	+	
		- Foam and Silicone	(available depends on the length of the residual limb p.21)	F+S	+	+	
	Fingers Construction (p.23)	Wired Fingers	(with filling)	(available depends on the size of Silicone Prostheses & the length of residual limb p.23)	W		
		Hinged Fingers			HF		
		Reinforced Fingers * fingers with RF may be larger in circumference * not available when selecting SCM option			RF		
		Fingers Bend (available only when selecting SCM) B1 (Straight), B2 (Standard) , B3 (Extra Bend)			B1/B2 /B3		
Zipper	Zipper (p.25) (plastic)		PZ	✓	✓		
Glue To Socket (p.25) (prosthetic socket is required)		GTS					

How to order : See page 148

Please use the product codes from previous page.

Example:

HDSFHT - ER - L - 15 - 3 - SCM	-	SC	-	S
Basic specification		Options: Aesthetics and Surface Enhancement		Options: Structural Changes

Measurements :

15cm

Model HDSFHT-ER (pg:104)	Thickness: Dorsal: 3.5mm	Plantar: 9.5mm	(mm)
Model HDSFHT (pg:104)	Thickness: Dorsal: 3.5mm	Plantar: 3.5mm	

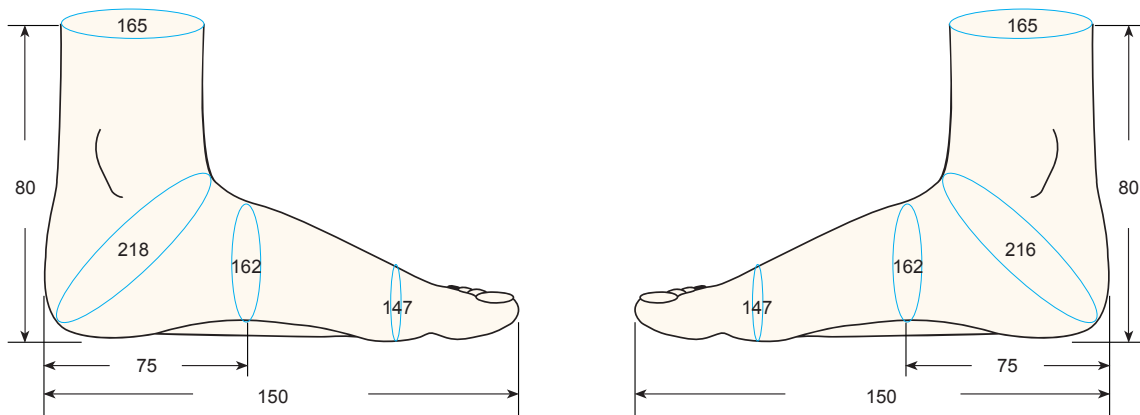

Upgrade Option

Myo-Electric & Mechanical Gloves

Gloves, Passive & Partial Hands, Digits

Footcovers

Leg / Arm Sleeve
Maxillofacial / Accessories

FAQ & Warranty

• All above information are for reference only •
• Please ask for more detail information •

Regal Silicone Prostheses

Upgrade Option

Myo-Electric & Mechanical Gloves

Gloves, Passive & Partial Hands, Digits

Footcovers

Leg / Arm Sleeve Maxillofacial / Accessories

FAQ & Warranty

Product: Silicone prosthetic footcover

Model: HDSFHT-ER (with carbon footplate)
HDSFHT

Size: 14cm

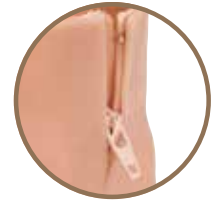

Plastic Zipper is integrated as standard feature

Carbon fiber energy restoring footplate

- ✓ = Standard feature
- O = Optional feature (no extra cost)
- + = Optional feature (extra cost)

Product Structure (List of all available features of each Model and Size)

Product features description			Code		Models	
			HDSFHT-ER	HDSFHT		
Basic Spec	Size	14	✓	✓		
	Side	L / R	✓	✓		
	Color - Single (use color sample from Regal)		✓	✓		
	Carbon Fiber Footplate		✓			
	Semi-Custom Made (p.7)	SCM	+	+		
Options: Aesthetics and Surface Enhancement	Color (p.14)	Dual Coloring Dorsal / Palmar (use color sample from Regal)	D/P	+	+	
		Custom Coloring (color sample is required)	CC	+	+	
	Nails, Hairs	X Series (p.16)	X	+	+	
		- Hair Dimension (available only when selecting X series)	2D / 3D	+	+	
		- Hair Color (available only when selecting X series) BB (Brown-Black), BR (Brown), BL (Black)	BB/BR /BL	+	+	
		Acrylic Nails (p.17)	ACRN			
	Smooth Coating	Smooth Coating (p.19)	SC	+	+	
Options: Structural Changes	Custom Filling (p.21)	- Foam	F	+	+	
		- Silicone	S	+	+	
		- Foam and Silicone	(available depends on the length of the residual limb p.21) F+S	+	+	
	Fingers Construction (p.23)	Wired Fingers	(with filling) (available depends on the size of Silicone Prostheses & the length of residual limb p.23) W			
		Hinged Fingers	HF			
		Reinforced Fingers * fingers with RF may be larger in circumference * not available when selecting SCM option	RF			
	Fingers Bend (available only when selecting SCM) B1 (Straight), B2 (Standard) , B3 (Extra Bend)	B1/B2 /B3				
Zipper	Zipper (p.25) (plastic)	PZ	✓	✓		
	Glue To Socket (p.25) (prosthetic socket is required)	GTS				

How to order : See page 146

Please use the product codes from previous page.

Example:

HDSFHT - ER - L - 14 - 3 - SCM	-	SC	-	S
Basic specification		Options: Aesthetics and Surface Enhancement		Options: Structural Changes

Measurements :

14cm

Model HDSFHT-ER (pg:104)	Thickness: Dorsal: 3.5mm	Plantar: 9.5mm	(mm)
Model HDSFHT (pg:104)	Thickness: Dorsal: 3.5mm	Plantar: 3.5mm	

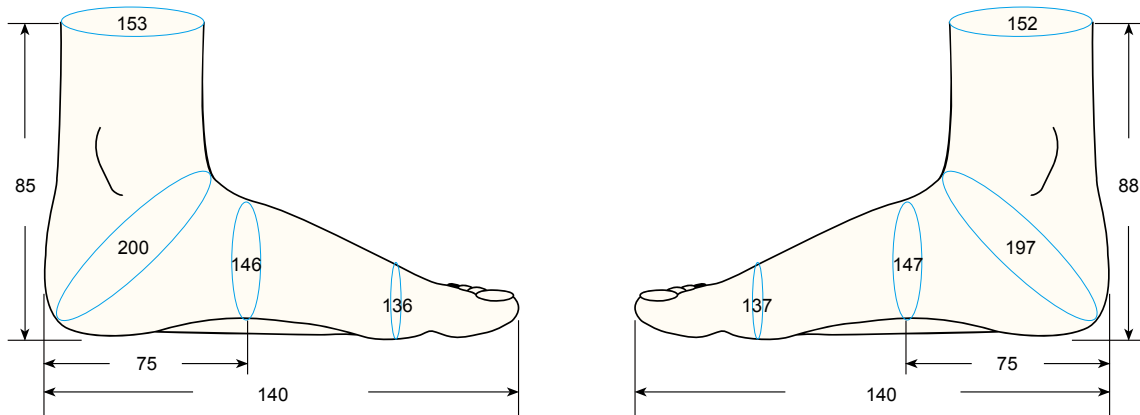

Upgrade Option

Myo-Electric & Mechanical Gloves

Gloves, Passive & Partial Hands, Digits

Footcovers

Leg / Arm Sleeve
Maxillofacial / Accessories

FAQ & Warranty

• All above information are for reference only •
• Please ask for more detail information •

Regal Silicone Prostheses

Product: Silicone Prosthetic arm sleeve

Model: SL-50, SL-29

Size: 450mm, 255mm

Product descriptions:

- Silicone prosthetic arm sleeve for covering from wrist to above elbow
- Upgrade options: See our Product Structure below



- ✓ = Standard feature
- O = Optional feature (no extra cost)
- + = Optional feature (extra cost)

Product Structure (List of all available features of each Model and Size)

Product features description				Models			
Basic Spec	Product features description			SL-50	SL-29		
	Size / Length		Code	450mm	255mm		
	Side		L / R				
	Color - Single (use color sample from Regal)			✓	✓		
	Semi-Custom Made (p.7)			+	+		
Options: Aesthetics and Surface Enhancement	Color (p.14)	Dual Coloring Dorsal / Palmar (use color sample from Regal)		D/P	+	+	
		Custom Coloring (color sample is required)		CC	+	+	
	Nails, Hairs	X Series (p.16)		X			
		- Hair Dimension (available only when selecting X series)	2D / 3D				
		- Hair Color (available only when selecting X series) BB (Brown-Black), BR (Brown), BL (Black)	BB/BR /BL				
		Acrylic Nails (p.17)		ACRN			
	Smooth Coating	Smooth Coating (p.19)		SC	+	+	
Options: Structural Changes	Wrist Connector (p.20)	- External threaded stud, Metric		EX-MT			
		- Internal , Metric		IN-MT			
		- External threaded stud, Imperial		EX-IP			
		- Internal, Imperial		IN-IP			
	Custom Filling (p.21)	- Foam		F	+	+	
		- Silicone		S			
		- Foam and Silicone	(available depends on the length of the residual limb p.21)	F+S			
	Fingers Construction (p.23)	Wired Fingers	(with filling)	(available depends on the size of Silicone Prostheses & the length of residual limb p.23)	W		
		Hinged Fingers		HF			
		Reinforced Fingers * fingers with RF may be larger in circumference * not available when selecting SCM option		RF			
Fingers Bend (available only when selecting SCM) B1 (Straight), B2 (Standard) , B3 (Extra Bend)		B1/B2 /B3					
Zipper	Zipper (p.25) (plastic)		PZ	+	+		
	Glue To Socket (p.25) (prosthetic socket is required)		GTS	+	+		

How to order : See page 146

Please use the product codes from previous page.

Example:

SL-50 - 3 - SCM	-	SC	-	F
Basic specification		Options: Aesthetics and Surface Enhancement		Options: Structural Changes

Measurement :

SL-50

Model SL-50 Thickness: 2-2.5mm (mm)

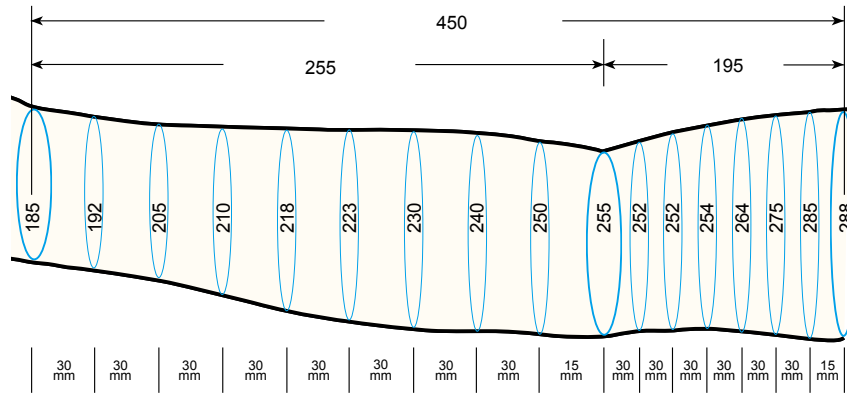

SL-29

Model SL-29 Thickness: 2-2.5mm (mm)

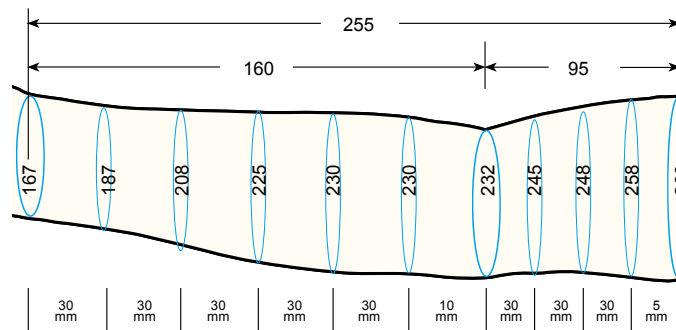

• All above information are for reference only •
• Please ask for more detail information •

Regal Silicone Prostheses

Upgrade Option

Myo-Electric & Mechanical Gloves

Gloves, Passive & Partial Hands, Digits

Footcovers

Leg / Arm Sleeve Maxillofacial / Accessories

FAQ & Warranty

Product: Silicone Prosthetic leg sleeve

Model: BKSL

Size: L, M

Product descriptions:

- Silicone prosthetic leg sleeve for covering from ankle to below knee
- Upgrade options: See our Product Structure below



- ✓ = Standard feature
- O = Optional feature (no extra cost)
- + = Optional feature (extra cost)

Product Structure (List of all available features of each Model and Size)				Models		
Basic Spec	Product features description			BKSL		
	Size		L / M	L	M	
	Side		L / R	✓	✓	
	Color - Single (use color sample from Regal)			✓	✓	
	Semi-Custom Made (p.7)	SCM		+	+	
Options: Aesthetics and Surface Enhancement	Color (p.14)	Dual Coloring Dorsal / Palmar (use color sample from Regal)	D/P	+	+	
		Custom Coloring (color sample is required)	CC	+	+	
	Nails, Hairs	X Series (p.16)		X		
		- Hair Dimension (available only when selecting X series)		2D / 3D		
		- Hair Color (available only when selecting X series)		BB/BR /BL		
		BB (Brown-Black), BR (Brown), BL (Black)				
	Acrylic Nails (p.17)		ACRN			
Smooth Coating	Smooth Coating (p.19)		SC	+	+	
Options: Structural Changes	Wrist Connector (p.20)	- External threaded stud, Metric		EX-MT		
		- Internal , Metric		IN-MT		
		- External threaded stud, Imperial		EX-IP		
		- Internal, Imperial		IN-IP		
	Custom Filling (p.21)	- Foam		F	+	+
		- Silicone		S		
		- Foam and Silicone	(available depends on the length of the residual limb p.21)	F+S		
	Fingers Construction (p.23)	Wired Fingers	(with filling)	(available depends on the size of Silicone Prostheses & the length of residual limb p.23)	W	
		Hinged Fingers			HF	
		Reinforced Fingers * fingers with RF may be larger in circumference * not available when selecting SCM option			RF	
Fingers Bend (available only when selecting SCM) B1 (Straight), B2 (Standard) , B3 (Extra Bend)			B1/B2 /B3			
Zipper	Zipper (p.25) (plastic)		PZ	+	+	
	Glue To Socket (p.25) (prosthetic socket is required)		GTS	+	+	

How to order : See page 146

Please use the product codes from previous page.

Example:

BKSL - L - L - 3 - SCM	-	SC	-	F
Basic specification		Options: Aesthetics and Surface Enhancement		Options: Structural Changes

How to measure : See page 147

BKSL-L

Model BKSL-L

Thickness: 2.5-3mm

(mm)

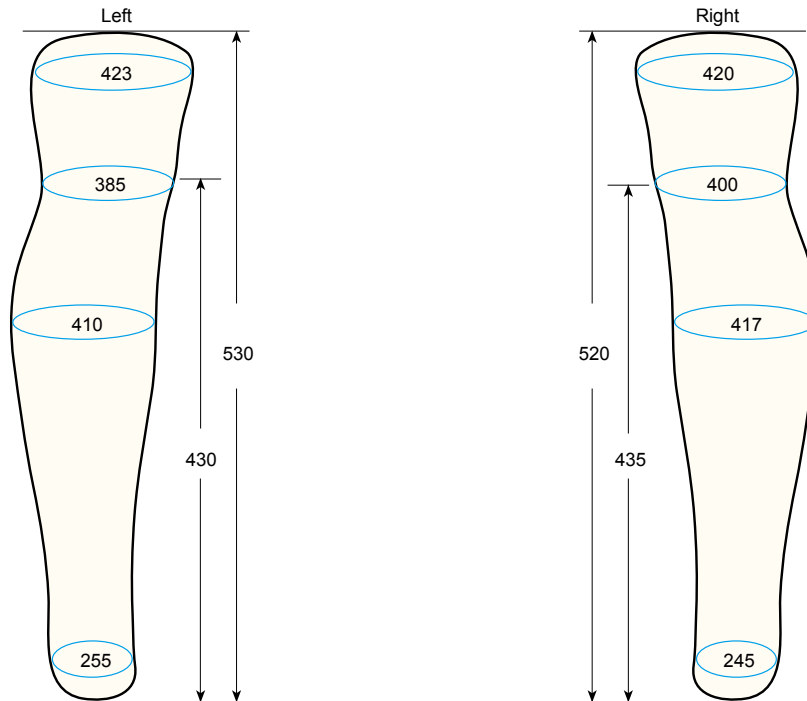

BKSL-M

Model BKSL-M

Thickness: 2.5-3mm

(mm)

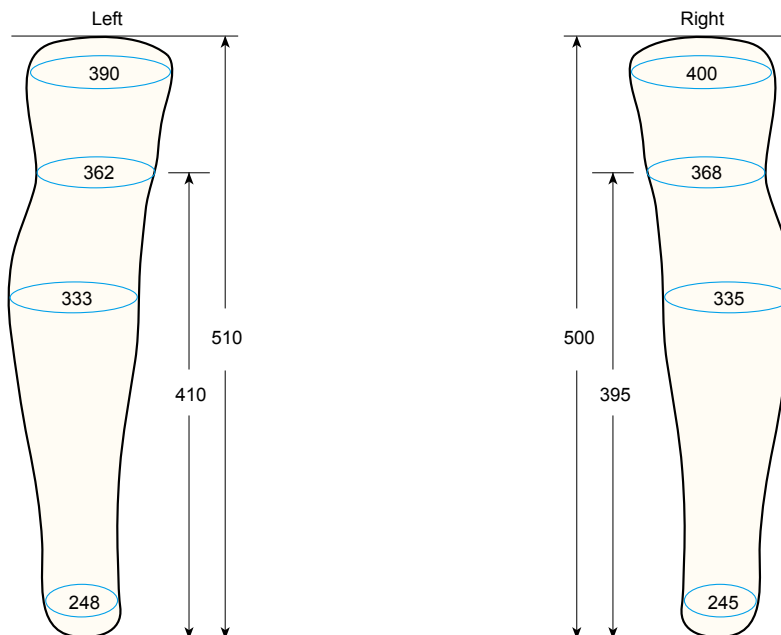

• All above information are for reference only •
• Please ask for more detail information •

Regal Silicone Prostheses

Product: Silicone maxillofacial prostheses (please contact us for ordering)

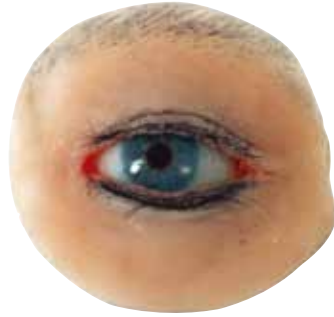

Upgrade Option

Myo-Electric & Mechanical Gloves

Gloves, Passive & Partial Hands, Digits

Footcovers

Leg / Arm Sleeve
Maxillofacial / Accessories

FAQ & Warranty

Medical adhesive

4-02-MAD



4-02-MAD

Medical adhesive

- Very good medical grade adhesive for holding silicone prostheses onto the residual limb

Product Code

4-02-MAD

Friction wrist connector (for prosthetic socket lamination)

4-02-WC-MT / 4-02-WC-IM



4-02-WC-MT

4-02-WC-IM

Friction wrist connector for prosthetic socket lamination

- Constant friction applied with a unique friction adjustment collar
- Consists of:
 - a friction unit connector (choice of M12x1.5 or 1/2"-20)
 - a friction adjustment collar
 - a thread stud (choice of M12x1.5 or 1/2"-20)

Product Code	Shape	Thread	Stud	Size
4-02-WC-MT-L	Oval shape	M12x1.5	Male/Female	L (550x395x160mm)
4-02-WC-IM-L	Oval shape	1/2"-20	Male/Female	L (550x395x160mm)
4-02-WC-MT-M	Oval shape	M12x1.5	Male/Female	M (490x380x160mm)
4-02-WC-IM-M	Oval shape	1/2"-20	Male/Female	M (490x380x160mm)
4-02-WC-MT-S	Oval shape	M12x1.5	Male/Female	S (380x280x160mm)
4-02-WC-IM-S	Oval shape	1/2"-20	Male/Female	S (380x280x160mm)

Regal silicone casting resin

4-02-CM



4-02-CM

Regal silicone casting material (for semi-custom made casting only)

- High elasticity
- Good for all types of residual limbs
- 1kg per pail
- Ratio for casting resin and casting hardener is 100g:4g
- To be used with Regal casting hardener (4-02-CMH)

Product Code

4-02-CM

Regal silicone casting hardener

4-02-CMH



4-02-CMH

Regal silicone casting hardener

- High elasticity
- Good for all types of stump
- To be used with Regal casting resin (4-02-CM)
- 100g per bottle
- Ratio for casting resin and casting hardener is 100g:4g

Product Code

4-02-CMH

Regal Silicone glue

4-02-SG



4-02-SG-85



4-02-SG-14.2

Regal Silicone glue

- one component adhesive made specifically for bonding RTV silicone rubber to silicone rubber and other materials
- can be used for acrylic nails

Product Code	Weight
4-02-SG-14.2	14.2gm
4-02-SG-85	85gm

Flexible PU Foam (Premium quality)

4-02-PUFA



4-02-PUFA

Flexible PU Foam

- Premium quality
- mixing ratio: 2 PUFA:1 PUFB
- 1kg per pail

Product Code

4-02-PUFA

Flexible PU Foam Hardener

4-02-PUFB



4-02-PUFB

Flexible PU Foam Hardener

- Hardener
- Similar to Pedilen Flexible Foam 300
- 1kg per pail

Product Code

4-02-PUFB

Upgrade Option

Myo-Electric &
Mechanical Gloves

Gloves, Passive &
Partial Hands, Digits

Footcovers

Leg / Arm Sleeve
Maxillofacial / Accessories

FAQ & Warranty

How to order

Ready Made Silicone Prosthesis:

Basic Specification:

Models - Gender - Side - Size - Color

Options - Aesthetics and Surface Enhancement:

Dual coloring /Custom coloring - X series - Acrylic nails - Smooth coating
 (p.14) (p.16) (p.17) (p.19)

Options - Structural Changes

Wrist Connector - Custom Filling - Fingers Construction - Zipper - Glue To Socket
 (p.20) (p.21) (p.23) (p.25) (p.25)

Example:

102LSL - M - L - M - 3 - SCM	- X - 2D - ACRN - SC	- HF - RF - PZ - GTS
Basic specification	Options: Aesthetics and Surface Enhancement	Options: Structural Changes

Sample of Product Structure Chart

Product Structure (List of all available features of each Model and Size)		Models						
Basic Spec	Product features description	Code	101L, 101LL	102L, 102LL	102LS, 102LSL	103	200 & Finger	
		Gender, Size	M-XL	✓	✓	✓	✓	✓
	Side	L / R	✓	✓	✓	✓	✓	
	Color - Single (use color sample from Regal)		✓	✓	✓	✓	✓	
	Semi-Custom Made (p.7)	SCM	+	+	+	+	+	
Options: Aesthetics and Surface Enhancement	Color (p.14)	D/P	+	+	+	+	+	
	Custom Coloring (color sample is required)	CC	+	+	+	+	+	
	X Series (p.16)	X	+	+	+	+	+	
	Nails, Hairs	2D / 3D	+	+	+	+	+	
		- Hair Dimension (available only when selecting X series)						
		- Hair Color (available only when selecting X series)	BB/BR /BL	+	+	+	+	
	Acrylic Nails (p.17)	ACRN						
	Smooth Coating (p.19)	SC	+	+	+	+	+	
Options: Structural Changes	Wrist Connector (p.20)	EX-MT			✓			
		IN-MT			O			
		EX-IP			O			
		IN-IP			O			
	Custom Filling (p.21)	F		+		+	+	
		S		+		+	+	
		F+S		+		+	+	
		Wired Fingers (with filling) (available depends on the length of the residual limb p.21)	W		✓	✓	O	O
		Hinged Fingers (available depends on the size of Silicone Prostheses & the length of residual limb p.23)	HF		+	+	+	+
		Reinforced Fingers (Fingers with RF may be larger in circumference * not available when selecting SCM option)	RF	+	+	+		
	Fingers Bend (available only when selecting SCM)	B1/B2 /B3					+	
	B1 (Straight), B2 (Standard) , B3 (Extra Bend)							
	Zipper (p.25) (plastic)	PZ	+	+	+	✓		
	Glue To Socket (p.25) (prosthetic socket is required)	GTS		+	+			

Product Codes of the above can be found in the Product Structure Chart of each sizes.

Semi-Custom Made (SCM) Silicone Prosthesis:

Order forms:

- S1:** For Partial Hand (Model 103)
- S2:** For Wrist or Above Wrist amputation and Arm Sleeve (Model 101L, 102L, 102LS, 101LL, 102LL, 102LSL, SL-29, SL-50)
- S3:** For Finger amputation (Model 200 series)
- S4:** For Partial Foot (Model HDSFHT, HDSFHT-ER, HDSF, HDSF-ER)
- S5:** For Toe amputation (Model TOE series)
- S6:** Leg sleeve (Model BKSL)
- TMOD:** Trial Prosthesis Modification Form (To be used after Trial Fitting)

All forms can be downloaded from our website www.regalprosthesis.com

How to measure

Length and Width : Finger



Palm



Wrist



Circumference : Finger



Palm and wrist



(Natural standing position)

Frequently Asked Questions

• Handling and Care

Q: How do I wear my silicone prosthesis?

A: Apply a thin amount of “water-based” lotion onto the clean and dry residual limb and slide the prosthesis over the residual limb. Once the lotion is absorbed it creates a suction fit. Too much lotion may make the prosthesis rotate out of position, in this case, remove excess lotion and reapply.

Q: Can I use oil based lubricant such as baby oil or vaseline?

A: Never use oil based lubricant as they will be absorbed into the silicone prosthesis and break down or discolor the silicone prosthesis.

Q: Sometimes it is hard to remove my silicone finger as it seems to be vacuumed very tightly, is there any easier way to take off the silicone finger?

A: The suction can be removed / diminished by pinching the proximal edge of the dorsal side of the silicone finger to create a tunnel of air. This will allow the finger to slide off. Sometimes repeated pinch and pull are necessary to work the prosthesis off. Never pull the prosthesis from the fingertips as this will only increase the suction and could damage the prosthesis.

Q: Can I wear the silicone prosthesis overnight?

A: Like wearing a mask, your skin needs to get fresh air and blood circulation. The silicone prosthesis must be removed every night to let your natural skin breathe. Prolonged wearing of the prosthesis may result in skin deterioration.

Q: How do I clean my silicone prosthesis?

A: The Regal silicone gloves are easy to clean with soapy water. It is important to remove any oil base stains promptly, otherwise the stains can be absorbed and will be impossible to remove. Never try to soak the silicone prosthesis in alcohol in attempting to clean the stains as the alcohol can open pores to the silicone layer and let the stains permeate even further.

Q: Can my silicone prosthesis be placed under direct sunlight?

A: Do not leave the silicone prosthesis under direct sunlight as the UV and heat may breakdown part of the color inside the silicone. Furthermore, silicone generally retains heat absorbed. Trying to wear a silicone prosthesis that has just been over-exposed to sunlight may cause burns to the patient.

Q: Is silicone prosthesis durable?

A: Silicone is a very durable material but still requires special care. If torn, it will continue to run and may not be repairable. If you find it begins to have a little cut, consult your certified prosthetist immediately. If you take good care of your silicone prosthesis, it can last for years.

Q: The surface of my glove is slightly tacky and it can be difficult to slide my clothes over the glove. What can I use to alleviate this?

A: You may try our Smooth Coating (SC) option. The coating lowers the friction of the silicone glove surface, this makes it easier to slide the clothes over the glove. For more information, please contact your certified prosthetist. Alternatively, you may put a donning bag or simply a piece of silky cloth over the silicone glove before sliding any clothing over the glove.

Q: Can I use my glove to push myself up or to control a steering wheel?

A: Regal Silicone Prosthesis is designed for cosmesis purpose only. It is not designed for other use other than cosmesis purpose.

• Colors

Q: *What is the full spectrum of the color range?*

A: Thirty-six colors are available, from fair to dark. Please ask for a Regal color sample. Where the patients couldn't find the appropriate color from the color range, they may go for custom coloring. A color sample is needed. Please ask for more information on "Color Selection".

Q: *How do the colors match with Otto Bock's system?*

A: Ottobock gloves are made from PVC which is not comparable. Silicone coloring has a more transparent base with better visual appeal. Please use a Regal color sample when seeing the patient and selecting the color with them. Patient details such as age, gender and size are better criteria for determining the most appropriate glove color. This is a much better option than using a number comparison.

Q: *Can you change the nail bed color?*

A: There have been some comments about the nail bed color of the Regal gloves looking too feminine. The nail bed can be changed to reflect a more masculine image. A color sample is needed.

Q: *Why doesn't my glove's palmar color match the Regal color I have chosen when I choose dual coloring option?*

A: The palmar color of our Dual Coloring is made by applying different colors layer by layer. Since Dual Coloring involves the combination of at least two colors, when fabricating the color of the palmar side, both palmar and dorsal color must be present in order to have a better transition finish. Because of the presence of the two colors the palmar color would not be same as the Regal color sample.

• Thickness

Q: *What is the thickness throughout the glove?*

A: There are different glove thicknesses for different applications. In myo gloves, the silicone at the finger tips is reinforced with fabric for added durability, which consequently makes the finger tips slightly thicker than the palm side.

• Weight

Q: *The passive hand is a bit heavy, can it be made lighter?*

A: The passive hands are made with foam filling. Foam densities (for firmness and durability) determine the weight of the passive hand. A lighter foam option is available upon request, but this will render the foam softer and less durable. Most customers prefer firmer foam to lightweight foam for increased durability. Tell us your requirements and we will provide you a solution.

• Thinning or Feathering

Q: *What is the preferred method for thinning or feathering the proximal end of the glove or individual finger?*

A: It is possible to grind the finger margin thinner for an improved cosmesis look; However, the reinforcement fabric under the thin silicone layer will be ground or exposed which may affect the durability of the prosthesis. Please ask for more information on "Trimming and Repair".

- **Sizing and fit**

Q: How do we select a hand style?

A: Measure Palm Circumference C1 of the sound hand then choose a few closest Sizes from Regal Size Measurement Chart. From the Sizes chosen, select the appearance that closely resemble to the sound hand. Note: some sizes are unisex. If the measurements do not match and the patient likes the chosen hand style, the patient may choose our SCM (semi-custom made) option to fabricate a glove that can fit well to the patient using the chosen hand style.

Please ask for more information on “Cast-taking for SCM (semi-custom made) cases”

Note: There may be occasions where the change in measurements are too large and beyond what SCM can do. In this case the patient must choose another hand style for SCM fabrication

Q: My patient has two fingers amputated with 10mm residual length each, should I choose single fingers or partial handglove?

A: Partial handglove (Model 103) is the best option. The critical factor is suspension of the prostheses. The shorter the residual limb the more likely you would need a partial handglove to ensure tha the prosthesis do not fall off.

If the patient does not wish to have a whole partial handglove, connected fingers or bridge to the adjacent finger may still be an available option (though not recommended).

Q: What measurements should be taken and how should we take measurements?

A: All data and measurements in our order forms are mandatory. The earlier the complete information is given the earlier we can begin fabrication. We have examples showing how to take proper measurements, see page 147 on “How to Measure”.

Q: What is the purpose of the Trial Prosthesis?

A: The Trial Prosthesis is used to check the fit and base color. Checking the fit includes checking the prosthesis dimensional fit, suspension and the fit of the inner filling. The color checking is to check whether the base color matches the patient’s skin color tone.

Note: the Trial Prosthesis is fabricated in single color including the nails.

Q: It takes quite a long time to wait for a Trial Prosthesis, can the time be shortened?

A: For every SCM cases, a new mold is created to ensure the mold dimension matches the patient’s residual limb. We are trying very hard to reduce the turnaround time and we appreciate your understanding.

To make the mold for SCM fabrication, we must have enough information about the residual limb condition. If our order form can be completely filled and photos are provided, this could help in shortening the time of SCM fabrication.

Q: If I found the Trial Prosthesis not fitting right what should I do?

A: Mark on the silicone prosthesis any differences required to be adjusted and fill in our Trial Modification form. Send them back to us for Final Prosthesis fabrication.

Please ask for more information on “Trial Modification”.

- **Options: Cut-out for partial digits on semi-custom hands**

Q: *What options are available for patients with remaining digits?*

A: For patients with remaining digits on hand or foot, you can request a cut-out section, which will be tapered to fit around the base of the digit(s). For hands, the cut-out will be made around each individual remaining finger. For feet, the cut-out will most likely be made around the multiple digits so as not to restrain blood circulation.

Q: *On occasion, when fitting a patient with a long glove, there is some wrinkling that occurs at the glove's elbow because it doesn't match where the natural elbow joint would be. What are your suggestions for fixing this?*

A: All Regal long gloves are now produced without the elbow imprinted.

Q: *Which models fit Otto Bock's Myoelectric hands?*

A: All Model 100/100L gloves match Otto Bock's myo hand
Male, Model 100/100L - XL — OB 8 and 8 ¼"
Male, Model 100/100L - L — OB 7-¾"
Male, Model 100/100L - M — OB 7-¼"
Female, Model 100/100L - M — OB 7-¼"

- **Options: Acrylic Nails**

Q: *Can I apply nail polish on my acrylic nails?*

A: Yes, you may apply nail polish. When you wish to remove the nail polish, make sure you use acetone free nail polish remover.

Q: *Is acrylic nails covered by warranty?*

A: Limited warranty see page 154-155

Q: *Should I replace the acrylic nails on the prosthesis glove myself?*

A: No. Please consult your certified prosthetist immediately.

Q: *Can I apply acrylic nails to my old prosthesis glove?*

A: Special properties have been applied during the fabrication stage, therefore acrylic nails can only be applied to the new Regal prosthesis with the upgrade option "ACRN" may apply acrylic nails to their prosthesis. Never apply acrylic nails to your existing prosthesis as it will ultimately be damaged. No warranty will be extended to cover such damage.

Q: *Can I send back my existing or old glove for this additional feature?*

A: No.

Q: *Can I use other type of acrylic nails glue other than Regal's?*

A: No.

- **Options: Smooth Coating**

Q: *What is smooth coating?*

A: Smooth coating is a layer of low coefficient of friction material that adheres onto the prosthesis surface. This layer can make sliding clothes over the prosthesis easier. Due to its low friction features, the coating helps postpone abrasion to the original silicone prosthesis underneath the smooth coating.

Q: *Do I need to take any special care with the smooth coated prosthesis compared to the regular silicone prosthesis?*

A: Yes, any inks, especially oil base ink, MUST BE cleaned immediately with soap and warm water, otherwise it will be absorbed into the prosthesis permanently.

Q: *Do I need to take any special care when cleaning the glove?*

A: Same as cleaning a glove without the coating. We recommend using a sponge or cloth instead of scotch-brite or similar for cleaning.

Q: *Will the smooth coating peel off in time?*

A: No, the coating will not peel off in time.

Q: *Will the smooth coating wear out over time?*

A: Yes the smooth coating will also be subjected to wear and tear over time of use, just like a running shoe sole.

Q: *How does the smooth coating resist to ink, including newspaper ink?*

A: Similar to the uncoated glove, for as long as the stain is taken care of immediately, the staining issue should be solved.

Q: *Is smooth coating covered by warranty?*

A: No, our warranty does not cover the smooth coating from daily wear and tear.

Q: *Is smooth coating applied only to new products?*

A: Yes, smooth coating applies only to the new products. Please therefore order product code "SC" when placing an order.

- **Options: Zippers**

Q: *What choices are available in zippers and why use one?*

A: All partial hands and partial feet and most passive hands are available with a zipper for ease of donning and doffing.

Q: *How is the durability and do I need to clean the zipper?*

A: The Zipper can be very durable and could be used over a long period of time with proper care. For hygienic purposes, we recommend the zipper be cleaned everyday after use. Simply immerse the prosthesis in warm, slightly soapy water and gently brush the teeth and the inner tongue with a soft hair toothbrush. Make sure the glove is completely dried before use.

- **Options: Custom Fillings**

Q: *What are the options for custom fillings?*

A: The options available are foam-only, silicone-only, or a mix of silicone and foam. For adults, we recommend foam only or a mix of silicone and foam, due to the weight factor. For pediatric hands any one of these options may be chosen, but silicone-only is recommended for the durability reasons.

- **Donning and Doffing**

Q: *Can you heat and pull on the glove?*

A: Heat does not change the physical characteristics of silicone material; therefore it is recommended the prosthetist applies a very thin WATER BASE lotion inside the glove before donning.

Q: *Is it possible to remove the inner foam hand (passive hand) from Model 102LS, 102LSL, 102L and 102LL?*

A: DO NOT remove the inner foam hand yourself as warranty will be void if the glove is torn during the removal of the inner foam hand.

Warranty and Return Policy

Limited Product Warranty

- Regal offers limited warranty under normal use and conditions.
(Note: please read carefully the Appendix A: Guideline for Warranty and Return Policy as it involves extra costs for some returns and no warranty for some product features)
- Regal Silicone Prostheses are warranted against defects in workmanship.
- The warranty starts the date the product is delivered to the patient. (a proof of fitting/delivery date with serial number of product is required). Without proper documentation, the delivery date to the practitioner will be the default warranty start date.

Our Warranty DOES NOT INCLUDE:

1. Trial prostheses;
 2. Daily wear and tear (e.g. repeated rubbing or friction against clothing, fabrics or other surfaces);
 3. Tear caused by sharp objects, fingernails, claws, bites or tools;
 4. Footcovers that are damaged or cut due to the shape of the footwear or sharp edges in shoes;
 5. Donning and doffing of the passive inner foam hand;
 6. Excessive repeated finger bending that causes damage or breaks the inner finger wires or finger hinges;
 7. Excessive use of the hand to carry heavy loading such as bags or using it to support or push the body;
 8. Product has been damaged due to misuse, operation beyond capacity, parts damaged by improper installation, exposed to a corrosive environment, any modification or repair by others that materially or adversely affected the product;
 9. Guideline for Warranty and Return Policy listed in the Appendix A
- In the case where it is not clearly evident whether the damage is due to either a production defect or normal wear and tear or improper use, Regal reserves the right to make the final determination;
 - Regal may recommend an extra feature or adjustment to the prosthesis to prevent the reoccurrence of the damage which may be subject to extra charge.

Terms of Sale

Order Cancellation:

- Orders can be cancelled free of charge within 48 hours after the order is confirmed by customers. Any orders that are cancelled after 48 hours will be billed full amount.
- Semi-Custom Made (SCM) orders:
 - 1) Trial prosthesis was sent and the customer decided not to make final prosthesis and the trial prosthesis return to us. (50% of the amount of the final prosthesis will be billed)
 - 2) Trial prosthesis was sent and customer decided not to make final prosthesis and that the trial prosthesis does not return us. (100% of the amount of the final prosthesis will be billed)

Return Authorisation

- Where defects occur, prepare the barcode serial number and inform Regal immediately (Barcode serial number can be found in either inside the prosthesis or on the front cover of the instruction booklet which comes along with the prosthesis);
- Take clear pictures of the damaged area;
- Explain how the damage occurs (e.g. occurs while donning);
- A Return Authorisation (RA) number must be obtained from Regal prior any goods being shipped for repair / replace / credit;
- Customers MUST mark the RA number when returning the prosthesis;
- Goods return without prior approval or without the Return Authorisation (RA) number are subject to refusal and will be returned at the customers' expenses;
- Freight charges for the original shipment remain the responsibility of the customers unless the error is due to incorrectly shipped item;
- Please inspect all orders immediately upon receipt. Contact Regal within five business days in the event of errors or damage;
- Guideline for Warranty / Return Policy is shown in Appendix A of next page
(Note: please read carefully the Appendix A: Guideline for Warranty and Return Policy as it involves extra costs for some returns and no warranty for some product features)

Appendix A: Guideline for Warranty and Return Policy

Products WITHOUT optional features

The warranty starts the date the product is delivered to the patient. (a proof of fitting/delivery date with serial number of product is required). Without proper documentation, the delivery date to the practitioner will be the default warranty start date.

	Within 3 months	3-12 months
Return goods that is still in brand new condition	Return for replacement / Return for credit (15% restocking fees)	
Return goods that is used, old or cannot be resold	Return not acceptable	
Return goods for repairing and can be repaired	Repair under warranty without extra charge	
Return goods for repairing but cannot be repaired or would not be durable after repairing <i>(Note: Regal will determine if it is suitable for repairing)</i>	One time replacement under warranty without extra charge	Treat as new order with 20% discount <i>(Note: the warranty begin date of the old prosthesis will be carried forward to the new prosthesis)</i>

Products WITH optional features

The warranty starts the date the product is delivered to the patient. (a proof of fitting/delivery date with serial number of product is required). Without proper documentation, the delivery date to the practitioner will be the default warranty start date.

	Within 3 months	3-12 months
Optional feature: Dual / Custom Coloring Return due to color not satisfied	Return not acceptable (Before making Final prosthesis, Trial prosthesis for color checking can be required with extra costs)	
Optional feature: X series Return due to X series characteristics not satisfied	Return not acceptable	
Optional feature: Acrylic Nails	Repair under warranty without extra charge	Repair with extra costs
Optional feature: Smooth Coating	Not covered by warranty	
Optional features: Wired Fingers, Hinged Fingers and Reinforced Fingers	Repair under warranty without extra charge	
Optional features: SCM (semi-custom made), Glue To Socket, Zipper and Custom Filling Return of the Final Prosthesis for repairing and can be repaired	Repair under warranty without extra charge	
Optional features: SCM (semi-custom made), Glue To Socket, Zipper and Custom Filling Return of the Final Prosthesis for repairing but cannot be repaired or would not be durable after repairing <i>(Note: Regal will determine if it is suitable for repairing)</i>	One time replacement under warranty without extra charge	Treat as new order with 20% discount <i>(Note: the warranty date of the new prosthesis is the date the new prosthesis is delivered to the patient)</i>
All Products WITH Optional features are not allowed for returning for credit		



REGAL PROSTHESIS LIMITED

Room 3D, Tower F, Mai Luen Industrial Bldg., 23-31 Kung Yip Street, Kwai Chung, NT, Hong Kong.

T : +852 2771 8991 / 2780 0982 / 3421 1885 F : +852 2384 5948 E : info@regalprosthesis.com <http://www.regalprosthesis.com>